



Agilent 8711C/8712C/8713C/8714C

RF Economy Network Analyzers

Data Sheet

8711C and 8712C, 300 kHz to 1.3 GHz
8713C and 8714C, 300 kHz to 3.0 GHz

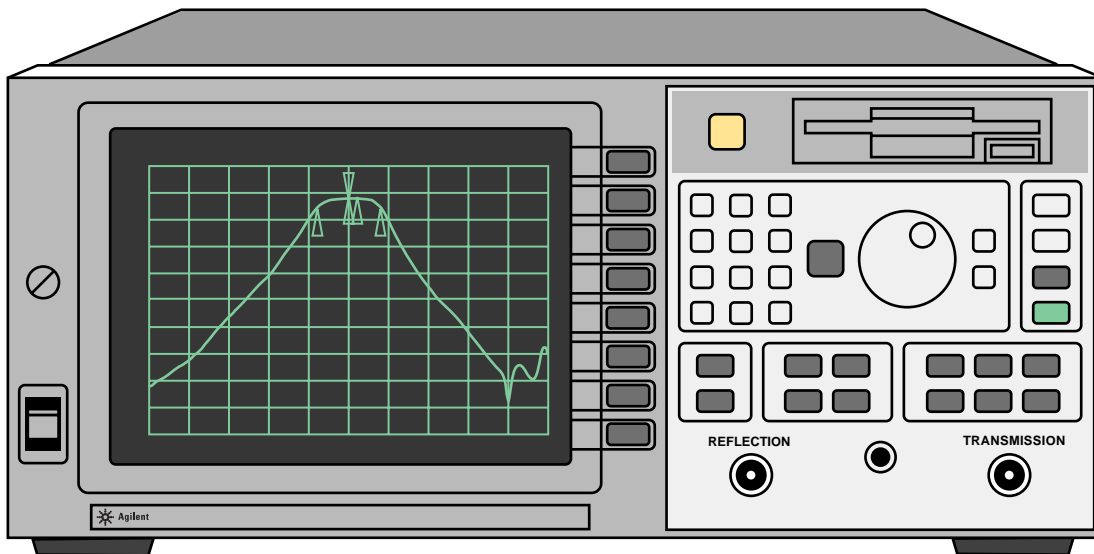

This document describes the system performance of the Agilent Technologies 8711C, 8712C, 8713C, and 8714C network analyzers, and provides two kinds of information:

Specifications describe the instruments' warranted performance over the temperature range of $25^{\circ} \pm 5^{\circ}\text{C}$, unless otherwise stated.

Supplemental characteristics are typical but nonwarranted performance parameters. These are denoted as "typical," "nominal," or "approximate."



Agilent Technologies

Innovating the HP Way

Specifications

Measurement Ports

| | 8711C and 8712C | 8713C and 8714C |
|-------------------------------------|------------------|---|
| Impedance | 50 and 75 ohm | |
| Directivity | 40 dB | 40 dB |
| Source match (reflection) | 30 dB | 30 dB |
| Source match (response calibration) | 14 dB typical | 23 dB typical at <1.3 GHz, 20 dB typical at >1.3 GHz |
| Source match (enhanced calibration) | 30 dB | 30 dB |
| Load match | 18 dB typical | 20 dB typical at <1.3 GHz, 18 dB typical at >1.3 GHz |
| Reflection tracking | ±0.02 dB typical | ±0.04 dB typical |

This table shows the residual Agilent 8711C, 8712C, 8713C, and 8714C system specifications. These characteristics apply at an environmental temperature of 25° ±5°C, with less than 1°C deviation from the calibration temperature. Directivity and source match specifications apply after calibration.

Source

Frequency

| | |
|------------|--|
| Range | 300 kHz to 1.3 GHz (8711C and 8712C) 300 kHz to 3.0 GHz (8713C and 8714C) |
| Resolution | 1 Hz |
| Stability | ±5 ppm 0°C to 55°C (typical) |
| Accuracy | 1) ±5 ppm at 25°C ±5°C 2) <1 Hz at 10% change in line voltage |

Harmonics

| |
|--------------------------------------|
| <-20 dBc, <1 MHz for 8711C and 8712C |
| <-30 dBc, >1 MHz for 8711C and 8712C |
| <-30 dBc for 8713C and 8714C |

Output Power

| | |
|----------------|---|
| Resolution | 0.01 dB |
| Level accuracy | ±1.0 dB ±1.5 dB Option 1EC ¹ ±2.0 dB Option 1E1 ±3.0 dB Option 1EC ¹ and 1E1 |

Maximum and Minimum Power (dBm)

| Options | 8711C and 8712C | | 8713C and 8714C | | | |
|---------------------------------|-----------------|----------|-----------------|---------------|---------------|---------------|
| | ≤1.0 GHz | >1.0 GHz | minimum power | maximum power | maximum power | maximum power |
| No options | 0 | 16 | 0 | 13 | -5 | 10 |
| 1E1 | -60 | 15 | -60 | 12 | -60 | 9 |
| 1EC ¹ | -3 | 13 | -3 | 10 | -8 | 7 |
| 1DA | -2 | 14 | -2 | 11 | -9 | 6 |
| 1E1 and 1EC ¹ | -60 | 12 | -60 | 9 | -60 | 6 |
| 1E1 and 1DA | -60 | 13 | -60 | 10 | -60 | 5 |
| 1EC ¹ and 1DB | -5 | 11 | -5 | 8 | -12 | 3 |
| 1EC ¹ , 1E1, and 1DB | -60 | 10 | -60 | 7 | -60 | 2 |

1. All power specifications with Option 1EC (75 ohms) are typical above 2.0 GHz.

Receiver

| | 8711C and 8712C | 8713C and 8714C |
|------------------------------------|--|-----------------------------|
| Frequency range | | |
| Narrowband | 300 kHz to 1.3 GHz | 300 kHz to 3.0 GHz |
| Broadband | 0.01 to 1.3 GHz | 0.01 to 3.0 GHz |
| Dynamic range² | | |
| Narrowband | | |
| 50 ohm | >100 dB, ≥ 5 MHz (+10 to -90 dBm) >60 dB, <5 MHz (+10 to -50 dBm) | >100 dB (+10 to -90 dBm) |
| 75 ohm | >97 dB, >5 MHz (+10 to -87 dBm) >57 dB, <5 MHz (+10 to -47 dBm) | >97 dB (+10 to -87 dBm) |
| Broadband | | |
| 50 ohm | > 66 dB (+16 to -50 dBm) | >66 dB (+16 to -50 dBm) |
| 75 ohm | > 63 dB (+16 to -47 dBm) | >63 dB (+16 to -47 dBm) |
| Maximum input | | |
| Narrowband (0.5 dB compression) | +10 dBm | +10 dBm |
| Broadband (0.55 dB compression) | +16 dBm | +16 dBm |
| Damage level | | |
| | +23 dBm, ±25 VDC | +23 dBm, ±25 VDC |
| Trace noise³ | | |
| Medium BW | ±0.2 dB | ±0.2 dB |
| Narrow BW | ±0.1 dB | ±0.05 dB |

- Receiver dynamic range is calculated as the difference between maximum receiver input level and receiver's noise floor. System dynamic range applies to transmission measurements only, since reflection measurements are limited by directivity. Noise floor is specified as the mean trace noise at specified CW frequencies. A signal at this level would have a signal to noise ratio of 3 dB. Noise floor is measured with test ports terminated in loads, response and isolation calibration, 15 Hz IF bandwidth, 10 dB source power, and no averaging.
- Measured at 0 dBm, excluding frequency response, transmission measurement.

Receiver Dynamic Accuracy

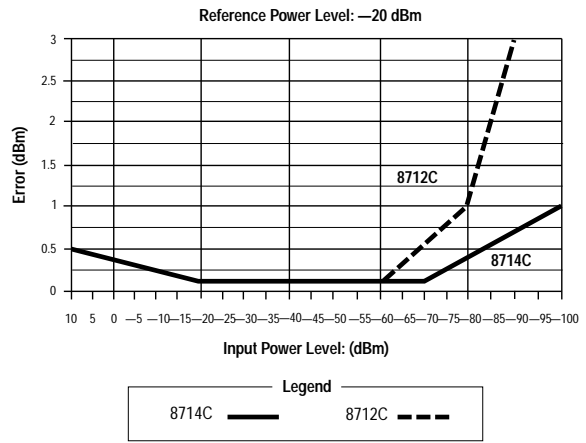

Narrowband

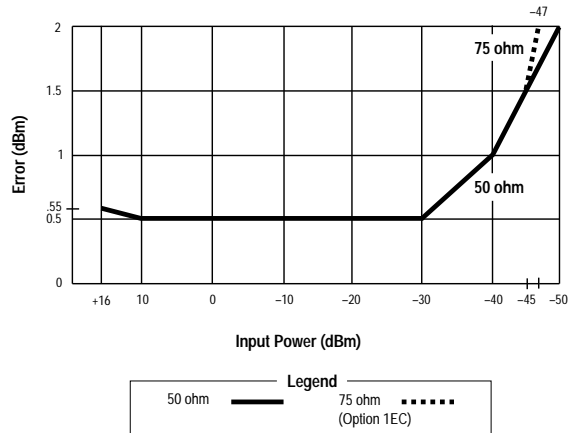

Broadband

Supplemental Data

Source Signal Purity

| | 8711C and 8712C | 8713C and 8714C |
|--|--------------------------------------|-----------------|
| Nonharmonic spurious | | |
| ≥50 kHz from carrier | <-20 dBc, <1 MHz <-30 dBc, ≥1 MHz | <-30 dBc |
| <50 kHz from carrier | <-25 dB | <-25 dBc |
| Phase noise (at 10 kHz offset) | | |
| | -70 dBc/Hz | -67 dBc/Hz |
| Residual AM (in 100 kHz bandwidth) | | |
| | <-50 dBc | <-50 dBc |
| Residual FM 30 Hz to 15 kHz | | |
| | <1.5 kHz peak | <1.5 kHz peak |

Display Characteristics

| | |
|--------------------|---------------------------------------|
| Amplitude | |
| Display resolution | 0.01 dB/division |
| Reference level | range: ±500 dB resolution: 0.01 dB |

8712C and 8714C

| | |
|--------------------|---------------------------------|
| Phase | |
| Range | ±180° |
| Display resolution | 0.1°/division |
| Marker resolution | 0.01° |
| Reference level | range ±360° resolution 0.01° |
| Polar scale range | 10μ to 1M/division |

Typical Measurement Uncertainty for Agilent 8714C at 1.3 GHz

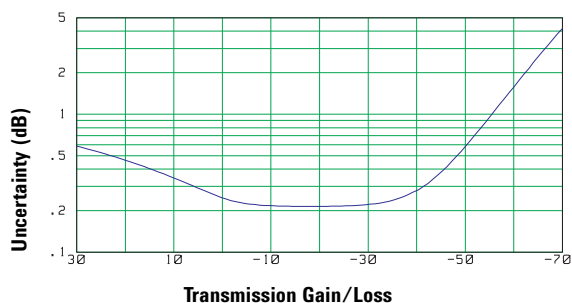

Transmission magnitude uncertainty



Reflection magnitude uncertainty

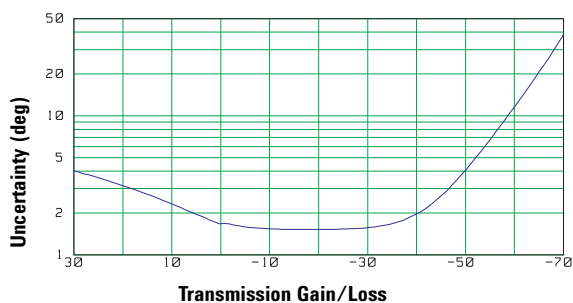

Transmission phase uncertainty

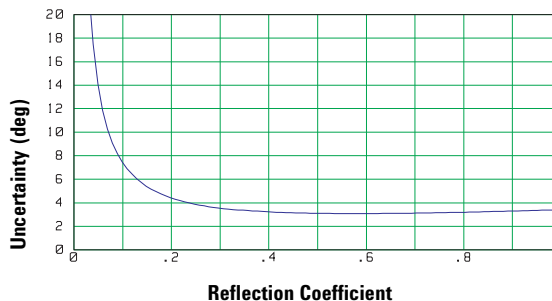

Reflection phase uncertainty

These graphs show the measurement uncertainty for the Agilent 8714C. The assumptions made to generate these curves were: For transmission uncertainty, $S_{11} = S_{22} = 0.0$; and for the reflection uncertainty, $S_{21} = S_{12} = 0.0$. Reflection

tracking = 0.01 dB, transmission tracking = 0.03 dB (computed from match terms), and trace noise = 0.25 dB. Power = 0 dBm for reflection measurements, and -20 dBm for transmission measurements, fine system bandwidth.

Group Delay

AM Delay (Option 1DA/1DB)

This option adds amplitude modulation group delay capability, which allows measurements of group delay through frequency-translation devices such as tuners or mixers. Using two external scalar detectors (Agilent 86200B or 86201B) and a power splitter (all included) this option measures group delay in any device that does not have limiting circuits, saturated amplifiers, or automatic gain control.

| | |
|-----------------------------|--------------------------|
| Aperture | 55.56 kHz |
| Resolution | 1 ns/division |
| Accuracy⁴ | ±4 ns |
| Delay range | 30 μsec (9000 m) |
| Amplitude range | -10 to +13 dBm (typical) |

AM Delay Dynamic Accuracy (typical)⁵

| Power | Delay |
|-------------|--------|
| 0 to 10 dB | ±10 ns |
| 10 to 20 dB | ±20 ns |

Group Delay

Group delay is computed by measuring the phase change within a specified frequency step (determined by the frequency span, and the number of points). This is also known as $d(\phi)/d(\omega)$.

Aperture

Maximum aperture: 20% of frequency span
 Minimum aperture: (frequency span) / (number of points - 1)

Range

The maximum delay is limited to measuring no more than 180° of phase change within the minimum aperture. Range = $1 / (2 \times \text{minimum aperture})$

Accuracy

The following graph shows group delay accuracy at 1.3 GHz with type-N transmission calibration and 15 Hz IF bandwidth. Insertion loss is assumed to be <2 dB and electrical length to be ten meters.

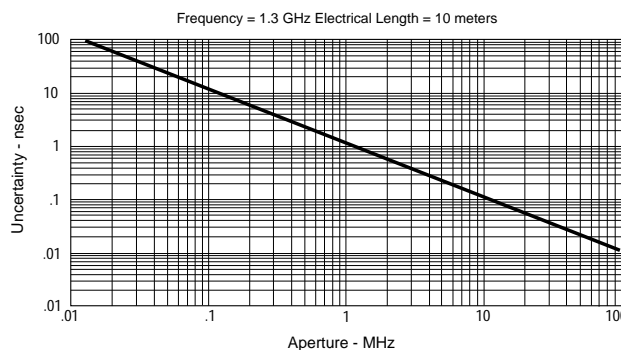

Group delay accuracy

4. Specified at 0 dBm, 16 averages, well-matched device, normalized.
 5. Normalized at +10 dBm.

Characteristics

Measurement

Number of display measurements

Two simultaneous measurements available

Measurements

- Narrowband: reflection (A/R), transmission (B/R), A, B, R
- Broadband: X, Y, Y/X, X/Y, Y/R*, power (B*, R*), conversion loss (B*/R*)

Formats

- Rectilinear: log or linear magnitude, SWR
- Phase, group delay, real and imaginary, Smith chart, and polar (8712C and 8714C only)

Data markers

Each display channel has eight markers. Markers are coupled between channels. Any one of eight markers can be the reference marker for delta marker operation. Annotation for up to four markers can be displayed at one time.

Marker functions

Markers can be used for various functions: marker search, mkr to max, mkr to min, mkr → target, mkr bandwidth, mkr delta frequency, mkr delta amplitude, and notch. Also with user-defined target values, mkr → center, mkr → reference, mkr → electrical delay are available. The tracking function enables continuous update of marker search values on each sweep.

For testing cable TV broadband amplifiers, the slope and flatness functions enable rapid tuning. Marker statistics enable measurement of the mean, peak-to-peak, and standard deviation of the data between two markers.

Storage

Internal memory

380 Kbytes of nonvolatile storage is available to store up to 20 instrument states via the save/recall menu. Instrument states can include all control settings, active limit lines, memory trace data, active calibration coefficients, and custom display titles.

Disk drives

Data, instrument states (including calibration data), and IBASIC programs can also be stored on disk, using the built-in disk drive. Data can be stored to disk in MS-DOS (R) format. Data can be stored in binary, PCX, HP-GL, or ASCII formats.

Data Hardcopy

Data plotting and printing

Hard copy plots are automatically produced with HP-GL compatible digital plotters such as the HP 7475A. Hardcopy prints can be dumped to compatible graphics printers such as the HP DeskJet or LaserJet (in single color or multicolor format). The analyzer provides Centronics, RS-232C, GPIB, and LAN interfaces.

Data listings

Printouts of instrument data are directly produced with a printer such as any HP DeskJet or LaserJet.

CRT formats

Single-channel, dual-channel overlay (both traces on one graticule), or dual-channel split (each trace on separate graticules).

Trace functions

Display current measurement data, memory data, or current measurement with memory data simultaneously. Vector division of current linear measurement values and memory data.

Display annotations

Start/stop, center/span, or CW frequency, scale/division, reference level, marker data, soft key functions, warning and caution messages, titles, clock, and pass/fail indication.

Limit lines

Create test limit lines that appear on the display for pass/fail testing. Limits may be any combination of lines or discrete points. Limit test TTL output available for external control or indication. Limit lines are only available in rectilinear formats.

Remote Programming Via GPIB

Interface

GPIB interface operates to IEEE 488.2 and SCPI standard interface commands.

Pass control

Allows the analyzer to request control of the GPIB (when an active controller is present) output to a plotter or printer.

System controller

Lets the analyzer become the controller on the GPIB bus to directly control a plotter or a printer.

Data transfer formats

- ASCII
- 32- or 64-bit IEEE 754 floating point format
- Mass memory transfer commands allow file transfer between external controller and analyzer.

Remote Programming Via LAN

SCPI Interface

Analyzer can be controlled by sending SCPI commands via TCP/IP to port 5025.

FTP Interface

Instrument state and data files can be transferred via FTP. Dynamic data disk provides direct access to instrument states, screen dumps, trace data, and operating parameters.

Determining Optimal Sweep Speed and Dynamic Range

Dynamic range, sweep time, and IF Bandwidth are interdependent quantities. Reducing sweep time usually results in a decrease in dynamic range. A compromise must be made depending upon the application. The following charts will help in making these tradeoffs. All data determined from preset conditions, except as noted.

Agilent 8714C dynamic range vs IF BW (typical)

| IF bandwidth | Narrowband dynamic range |
|------------------|--------------------------|
| Wide (6500 Hz) | 70 dB typical |
| Medium (3700 Hz) | 90 dB typical |
| Narrow (250 Hz) | 105 dB typical |
| Fine (15 Hz) | 110 dB typical |

Measurement sweep times (msec) (typical)

| IF BW | Span | 8711C and 8712C | | 8713C and 8714C | |
|--------|---------|-----------------|-------|-----------------|-------|
| | | fwd | cycle | fwd | cycle |
| Medium | Full | 132 | 159 | 182 | 223 |
| Wide | Full | 64 | 72 | 118 | 159 |
| Wide | 200 MHz | 51 | 59 | 68 | 87 |

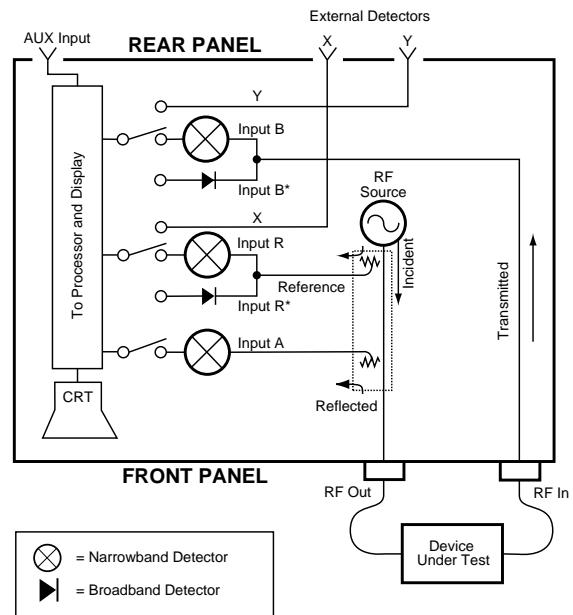

Agilent 8711C/8712C/8713C/8714C block diagram

Determining Automated Test Configuration

These charts show that IBASIC CSUBs can access the trace data faster than an external computer. Also, if only a few trace points need to be queried, using markers can be faster.

Trace Transfer Time via GPIB (in milliseconds)

Entering trace data into the S700 workstation:

| Data | Format | Number of points | | | | |
|-----------|----------|------------------|-----|-----|-----|------|
| | | 11 | 51 | 201 | 401 | 1601 |
| Formatted | ASCII | 14 | 43 | 160 | 305 | 1200 |
| Formatted | Real, 64 | <10 | <12 | 20 | 34 | 105 |
| Formatted | Real, 32 | <10 | 11 | 20 | 24 | 62 |
| Corrected | ASCII | 20 | 79 | 294 | 574 | 2239 |
| Corrected | Real, 64 | <10 | 16 | 31 | 50 | 172 |
| Corrected | Real, 64 | <10 | 12 | 23 | 34 | 110 |
| Corrected | Int, 16 | <10 | 11 | 20 | 26 | 69 |

Entering trace data into IBASIC using CSUBs:

| Data | Format | Number of points | | | | |
|-----------|----------|------------------|----|-----|-----|------|
| | | 11 | 51 | 201 | 401 | 1601 |
| Corrected | Real, 64 | 7 | 7 | 10 | 15 | 39 |
| Formatted | Real, 64 | 7 | 7 | 9 | 13 | 32 |

Entering a single marker via GPIB:

CALC1: MARK1: Y? <10 ms

Calibration

Measurement Calibration

Calibration significantly reduces measurement uncertainty due to errors caused by system directivity, source match, reflection tracking, and crosstalk. These analyzers reduce systematic errors with a built-in calibration so that measurements can be made on many devices without performing a user calibration.

For greater accuracy, especially for special test setups, the analyzers offer one-port reflection calibration to remove reflection errors. For transmission measurements, the analyzers offer a response calibration to remove transmission tracking errors, a response and isolation calibration to remove transmission tracking and crosstalk errors, and enhanced response calibration to remove transmission tracking and source match errors.

The interpolated mode recalculates the error coefficients when the test frequencies or the number of points are changed. The resulting frequency range must be within or equal to the user calibration frequency span. System performance is not specified for measurements with interpolated error correction applied.

Calibrations Available

Transmission Measurements

- **Normalization**
Simultaneous magnitude and phase correction of frequency response errors for transmission measurements. Requires a through connection. Used for both narrowband and broadband measurements. Does not support interpolation.
- **Response**
Simultaneous magnitude and phase correction of frequency response errors for transmission measurements. Requires a through connection.
- **Response and isolation**
Compensates for frequency response and crosstalk errors. Requires a load termination on reflection and transmission ports and a through connection.
- **Enhanced response**
Compensates for frequency response and source match errors. Requires open, short, load, and through connections.

Reflection Measurements

- **One-port calibration**
Calibrates reflection port to correct directivity, tracking, and source match errors. Requires an open, short, and load.

Calibration Kits

Data for several standard calibration kits are stored in the instrument for use by calibration routines. They include:

- 3.5 mm
- type-F 75 ohm
- type-N 50 ohm
- type-N 75 ohm

In addition you can also describe the standards for a user-defined kit (for example, open-circuit capacitance coefficients, offset short length, or fixed loads).

The following calibration kits available from Agilent contain precision standards in many different connector types. For further information, consult the *RF Economy Network Analyzer Configuration Guide*, literature number 5965-1461.

Agilent 85032B/E 50-ohm type-N calibration kit

Contains precision 50 ohm type-N standards used to calibrate the analyzer to measure devices with 50 ohm type-N connectors. E versions do not contain adaptors or female standards.

Agilent 85036B/E 75-ohm type-N calibration kit

Contains precision 75 ohm type-N standards to calibrate the analyzer to measure devices with 75 ohm type-N connectors. E versions do not contain adaptors or female standards.

Agilent 85039A type-F calibration kit

Contains 75 ohm type-F standards to calibrate the analyzer to measure devices with type-F connectors.

Agilent 85033D Option 001 3.5 mm calibration kit

Contains precision 3.5 mm standards to calibrate the analyzer to measure devices with 3.5 mm or SMA connectors.

Options

Standard Options

75 ohms (Option 1EC)

Provides 75 ohm system impedance.

Step attenuator (Option 1E1)

This option adds a built-in 60 dB step attenuator, extending the source output power low-end range to -60 dBm.

IBASIC (Option 1C2)

This option adds a resident IBASIC system controller, facilitating automated measurements, and control of other devices. Using keystroke recording for the simplest applications, or an optional keyboard to write complex control and calculation programs, IBASIC improves productivity by customizing your measurements.

AM delay (Option 1DA [50 ohm], 1DB [75 ohm])

This option adds amplitude modulation group delay capability, which allows measurements of group delay through frequency-translation devices such as tuners or mixers. Using two external scalar detectors (Agilent 86200B or 86201B) and a power splitter (all included) this option measures group delay in any device that does not have limiting circuits, saturated amplifiers, or automatic gain control.

Fault location and structural return loss software (Option 100)

For fully characterizing cable performance, this software package provides *both* fault location and structural return loss. Structural return loss is a special case of return loss measurements. Physical damage of cable, by handling or manufacturing process, causes reflections. Structural return loss occurs when these periodic reflections sum at half-wavelength spacing and reflect the input signal.

LAN (Option 1F7)

This option adds a LAN interface and firmware to support data and control via direct connection to a 10 Base-T (Ethertwist) network. Both TCP/IP and FTP protocols are supported.

Special Options

Switching test sets

Switching test sets enhance productivity by allowing multiple measurements with a single connection to the device under test. They are available in several configurations. Please contact your Agilent sales representative for more information.

General Characteristics

Front Panel Connectors

| | |
|----------------|--|
| Connector type | type-N female |
| Impedance | 50 ohms (standard) 75 ohms (Option 1EC) |
| Probe power | +15V 200 mA -12.6V 250 mA |

Rear Panel Connectors

| | |
|--------------------|---------------------------------|
| External reference | 10 MHz, > -5 dBm, 50 ohm BNC |
|--------------------|---------------------------------|

Auxiliary input

The auxiliary input measures the DC level at each sweep point. If the slew rate on this input exceeds 700 mV/msec, increased measurement errors will result.

| | |
|------------------|---|
| Calibrated range | $\pm 10V$ |
| Accuracy | $\pm(3\% \text{ of reading} + 20 \text{ mV})$ |
| Damage level | $>15 \text{ Vdc}$ |

External trigger

This normally high open-collector TTL line will under normal circumstances, output a negative pulse for each data point measured.

Limit test output

This normally high open-collector line is pulled low whenever a limit test fails.

User TTL input/output

This open-collector line may be used to output a “high sweep” signal, as an input to trigger the “Fast Save/Recall” function, or it may be programmed as an input/output signal using IBASIC.

VGA video output

Provides VGA compatible video signal.

GPIB

Allows communications with compatible devices including external controllers, printers, plotters, and power meters.

X and Y external detector inputs

Provides for two external detector inputs. See the *Agilent 86200B and 86201B Data Sheet*, literature number 5962-9931E.

Parallel port

This 25-pin female connector is used with parallel (or Centronics interface) peripherals such as printers and plotters. It can also be used as a general-purpose I/O port, with control provided by IBASIC.

LAN

This RJ-45 connector allows direct connection to a 10 Base-T (Ethertwist) network. TCP/IP protocol is supported.

RS-232C

This 9-pin male connector is used with serial peripherals such as printers and plotters.

Mini-DIN keyboard

This 6-pin-connector is used for adding an IBM PC-AT compatible keyboard for titles, remote front-panel operation, and for IBASIC programming (Option 1C2).

Line power

47 to 60 Hz
115V nominal (90V to 132V) or 230V nominal (198V to 264V) 230 VA max.
A third-wire ground is required.

Environmental Characteristics

General conditions

RFI and EMI susceptibility defined by CISPR Publication 11.

ESD (electrostatic discharge) should be minimized by the use of static-safe work procedures and an antistatic bench mat (such as an Agilent 92175T).

The sealed flexible rubber keypad protects key contacts from dust, but the environment should be as dust-free as possible for optimal reliability.

Operating environment

| | |
|-------------|--------------------------------------|
| Temperature | 0° to 55°C |
| Humidity | 5% to 95% at 40°C (noncondensing) |
| Altitude | 0 to 4,500 meters (15,000 feet) |

Storage conditions

| | |
|-------------|---|
| Temperature | −40°C to +70°C |
| Humidity | 0 to 90% relative at +65°C (noncondensing) |
| Altitude | 0 to 15,240 meters (50,000 feet) |

Cabinet dimensions

The following dimensions exclude front and rear panel protrusion:

179 mm H x 425 mm W x 514 mm D
(7.0 in x 16.75 in x 20.25 in)

Weight

| | |
|----------|---------|
| Net | 20.5 kg |
| Shipping | 30 kg |

Agilent Technologies' Test and Measurement Support, Services, and Assistance

Agilent Technologies aims to maximize the value you receive, while minimizing your risk and problems. We strive to ensure that you get the test and measurement capabilities you paid for and obtain the support you need. Our extensive support resources and services can help you choose the right Agilent products for your applications and apply them successfully. Every instrument and system we sell has a global warranty. Support is available for at least five years beyond the production life of the product. Two concepts underlie Agilent's overall support policy: "Our Promise" and "Your Advantage."

Our Promise

"Our Promise" means your Agilent test and measurement equipment will meet its advertised performance and functionality. When you are choosing new equipment, we will help you with product information, including realistic performance specifications and practical recommendations from experienced test engineers. When you use Agilent equipment, we can verify that it works properly, help with product operation, and provide basic measurement assistance for the use of specified capabilities, at no extra cost upon request. Many self-help tools are available.

Your Advantage

"Your Advantage" means that Agilent offers a wide range of additional expert test and measurement services, which you can purchase according to your unique technical and business needs. Solve problems efficiently and gain a competitive edge by contracting with us for calibration, extra-cost upgrades, out-of-warranty repairs, and on-site education and training, as well as design, system integration, project management, and other professional services. Experienced Agilent engineers and technicians worldwide can help you maximize your productivity, optimize the return on investment of your Agilent instruments and systems, and obtain dependable measurement accuracy for the life of those products.

By internet, phone, or fax, get assistance with all your test and measurement needs.

Online Assistance

www.agilent.com/find/assist

Phone or Fax

United States:

(tel) 1 800 452 4844

Canada:

(tel) 1 877 894 4414

(fax) (905) 206 4120

Europe:

(tel) (31 20) 547 2323

(fax) (31 20) 547 2390

Japan:

(tel) (81) 426 56 7832

(fax) (81) 426 56 7840

Latin America:

(tel) (305) 269 7500

(fax) (305) 269 7599

Australia:

(tel) 1 800 629 485

(fax) (61 3) 9272 0749

New Zealand:

(tel) 0 800 738 378

(fax) (64 4) 495 8950

Asia Pacific:

(tel) (852) 3197 7777

(fax) (852) 2506 9284

Product specifications and descriptions in this document subject to change without notice.

Copyright © 1996, 2000 Agilent Technologies

Printed in U.S.A. 5/00

5965-1464E



Agilent Technologies

Innovating the HP Way