

ADVANTEST

D3186/3286
Pulse Pattern Generator/Error Detector

150 Mbps to 12.5 Gbps Error Performance Test System
Suitable for SDH/SONET



D3186/3286



To accommodate transmission of large-capacity information in the coming multimedia generation, ultra high-speed digital telecommunications networks are being constructed. For evaluation and analysis of O/E and E/O modules and ultra high-speed logic devices used for multiplexers and repeaters for telecommunications systems, a signal source with high speed and high quality is necessary. The D3186 Pulse Pattern Generator/D3286 Error Detector offers excellent waveforms with high speed and high quality and diverse error detecting functions in an operating frequency range from 150 Mbps to 12.5 Gbps. In addition, with the 8 M-bit large capacity memory and ADVANTEST's unique frame pattern generation function, the D3186/D3286 is a new generation of error performance test system which is compatible with STM-1 (155.52 Mbps) to STM-64 (9.95 Gbps) in SDH/SONET.

Features

D3186 Pulse Pattern Generator

- Excellent waveform quality
- Generation of SDH/SONET frame patterns (mixed patterns) which are close to actual data
- 8 M-bit memory, 31 stages for PRBS
- Multi-channel output : 2 data channels, 3 clock channels, and 7 sub-rate channels
- Cross point variable for output waveform
- Burst signal output
- 3 Vp-p outputs, effective for EA modulators, etc. (option)

D3286 Error Detector

- SDH/SONET frame synchronization suitable for system evaluation
- Error detection with area specification effective for SDH frame and ATM cell measurement
- Burst data measurement effective for loop-back test
- Auto search function which adjusts the most appropriate timing and voltage
- Monitor output of data and clock
- FD drive for storing measurement results and setup data
- GUI environment realizing easy and legible operating environment

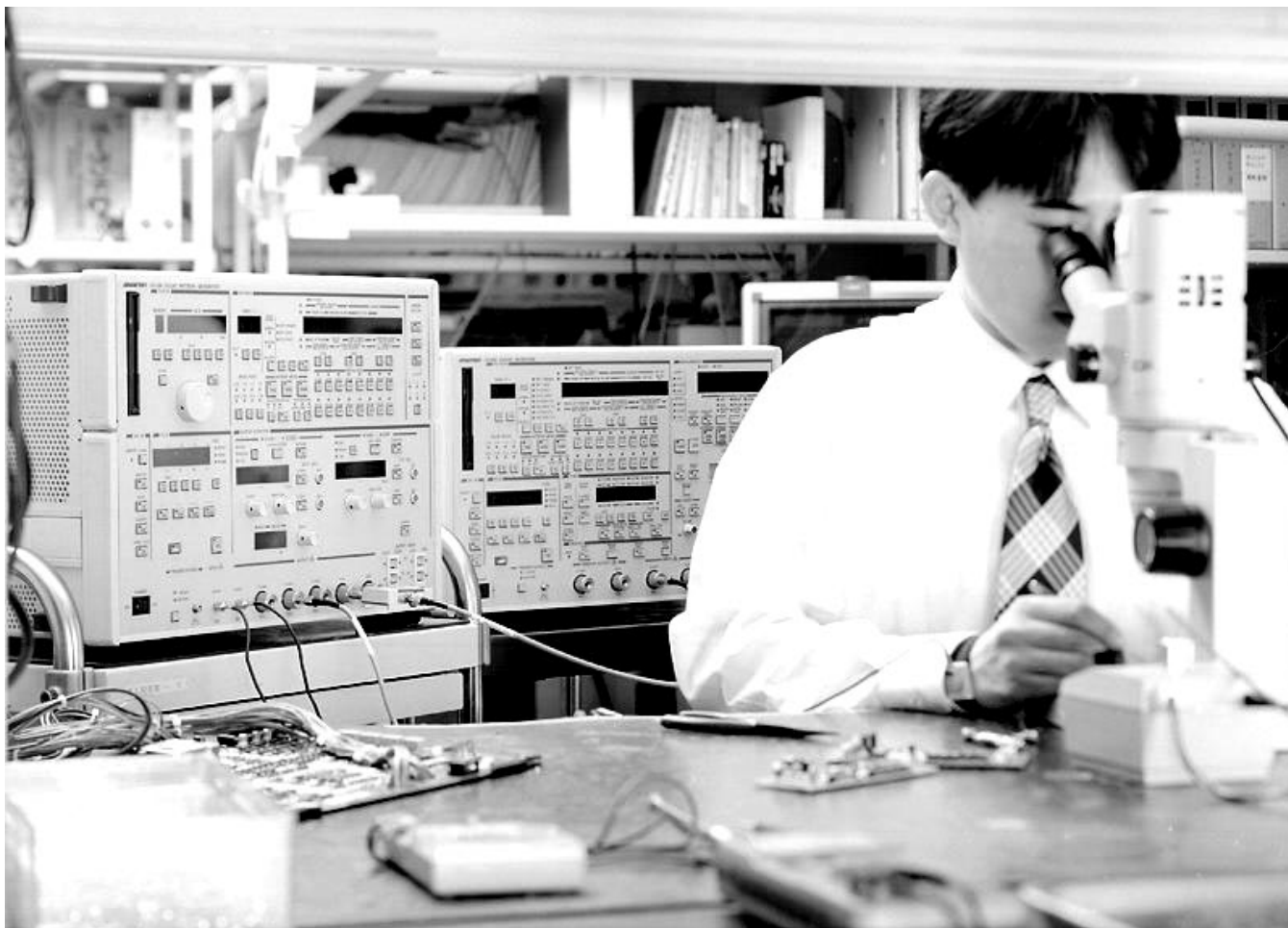

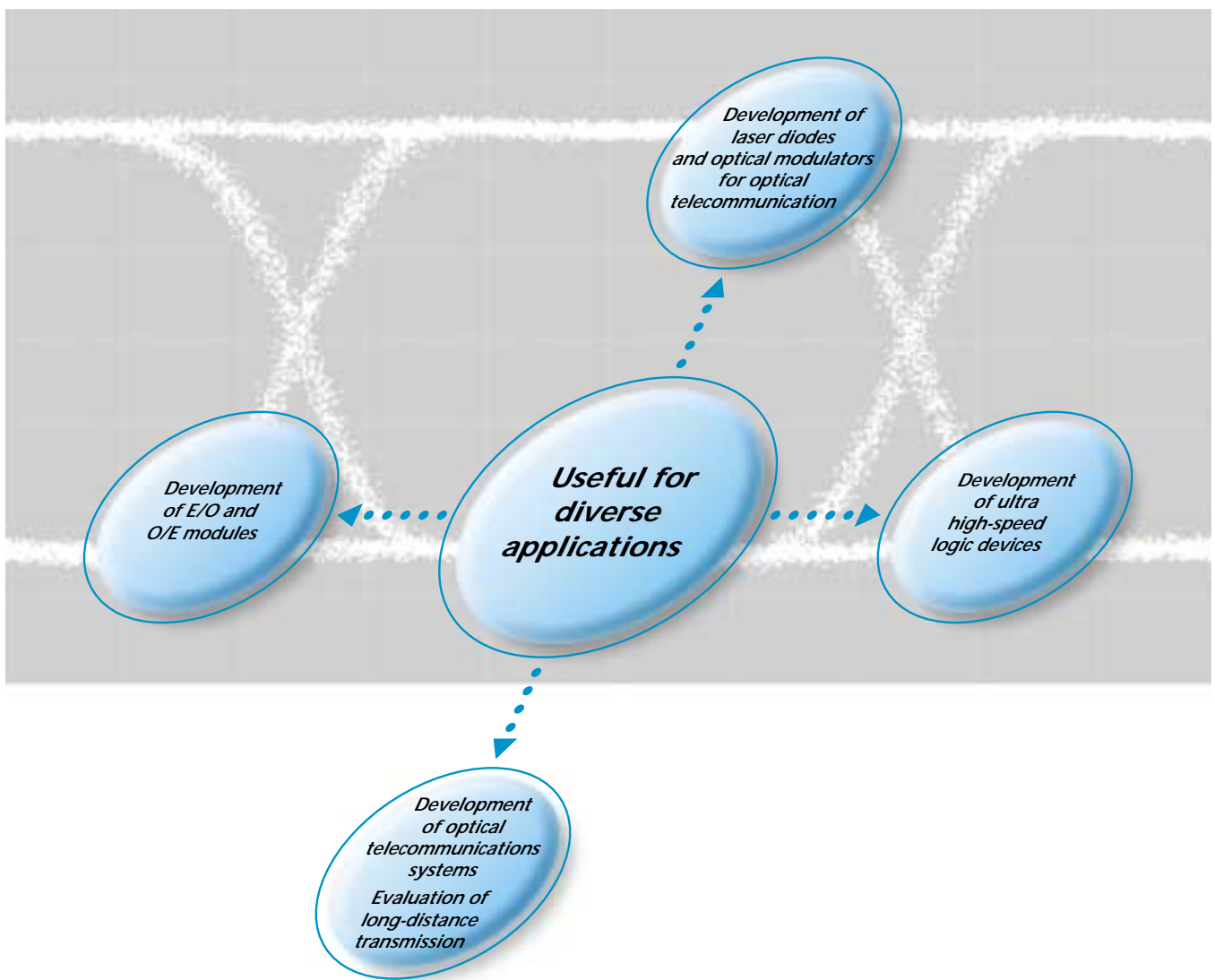

GUI (Graphical User Interface) Provides Simple, Easily Viewed Operating Environment

So that the abundant functions of the D3186/D3286 can be used even more easily, we have designed a graphic operating environment which can be viewed on a personal computer screen. (* for Microsoft Windows environment)

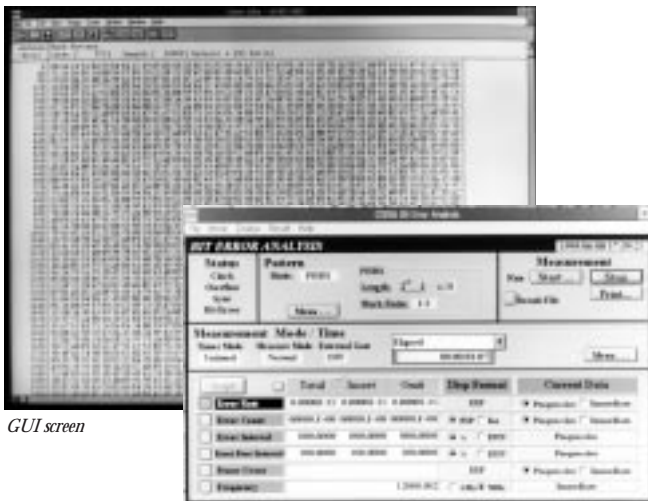

GUI screen

*Windows is a trademark of Microsoft Corporation

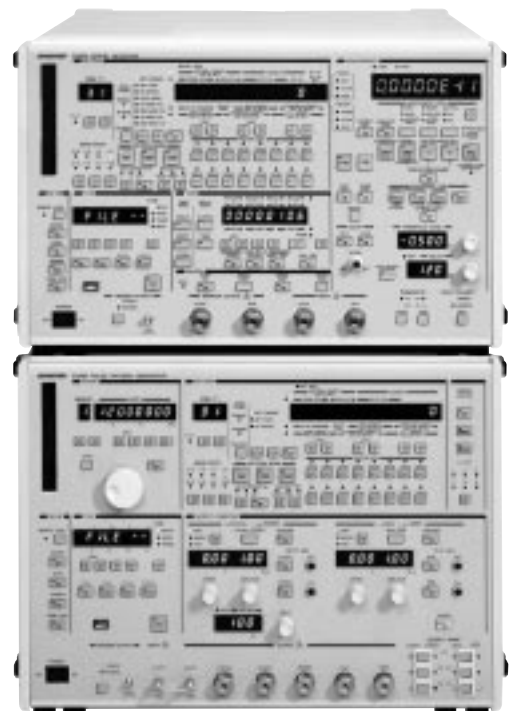

Offers Excellent Waveform Quality

For Performance Evaluation of Optical Components

High waveform quality is essential to evaluate the performance of laser diodes and optical components for optical telecommunication. To meet this demand, the D3186 Pulse Pattern Generator provides excellent waveforms with high speed and high quality. In addition, the D3186 has a wide cross point variable range for the output waveform that makes it easy to control the output waveform correction mark ratio.

Use As a Modulation Signal Source for Optical Modulators

When used together with the Q7606A/B Lightwave Modulation Test Set from ADVANTEST, the D3186 provides a suitable modulation signal source in a chirp measurement system for optical modulators.

Use this function key

• D3186

C-P ADJ

ADJ

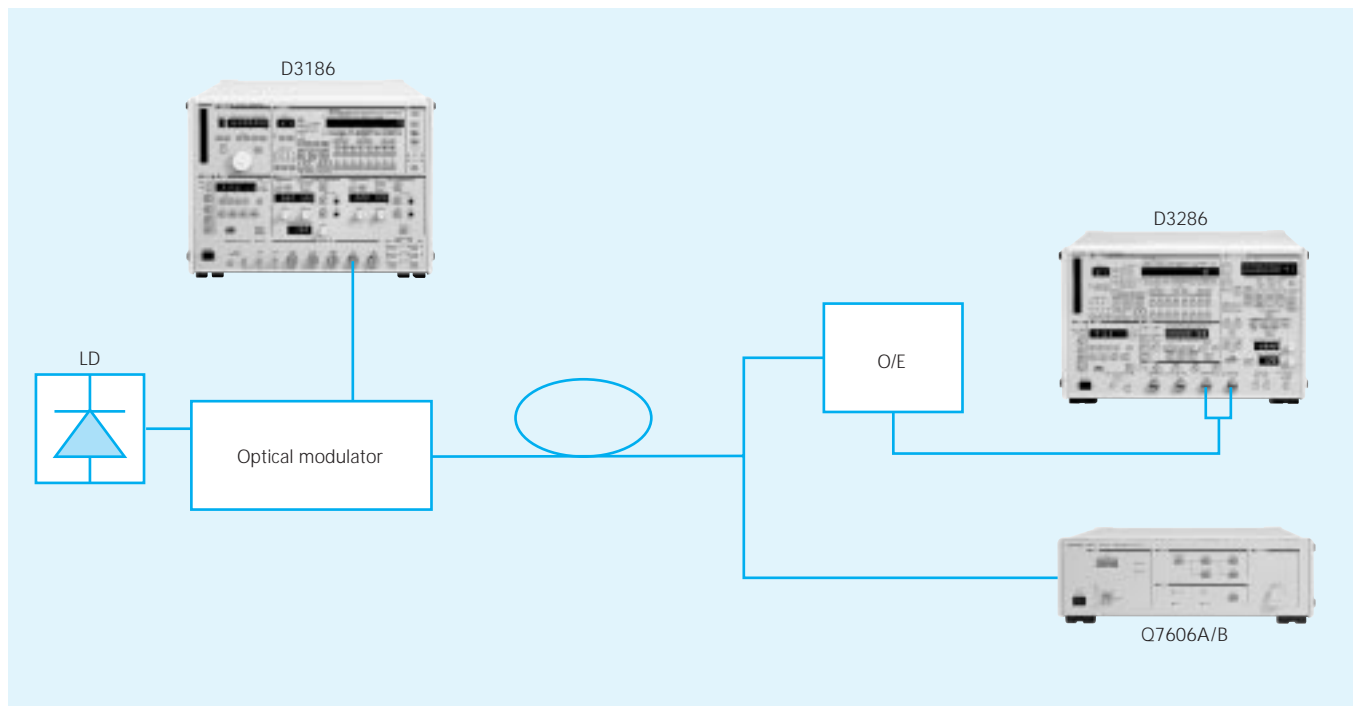

Cross point variable for output waveform (20 to 80%)

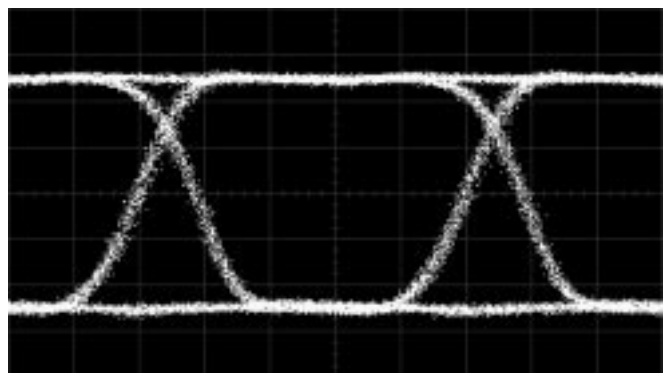
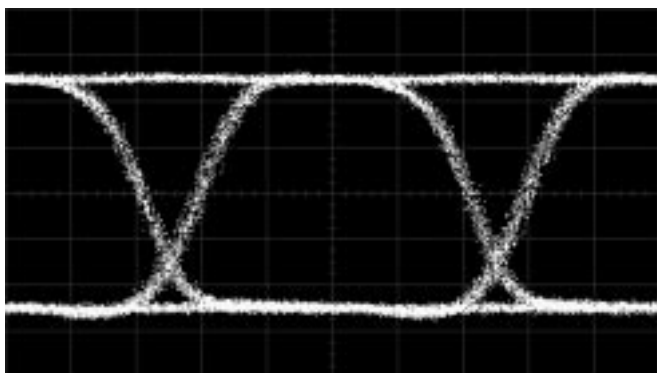

10 Gbit/sec

Excellent Waveform Quality

Through output waveform re-timing, a data output waveform with excellent eye balance, low jitter, and low distortion has been realized.

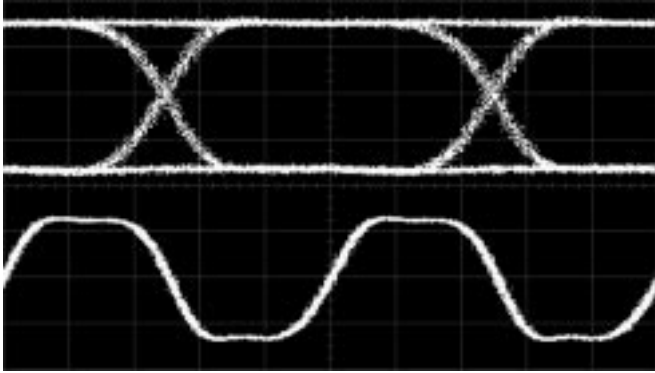

Favorable Matching with 50 ohm Output Impedance

With 50 ohm output impedance matching, waveform distortion due to impedance mismatching does not occur even if a mismatched DUT is connected.

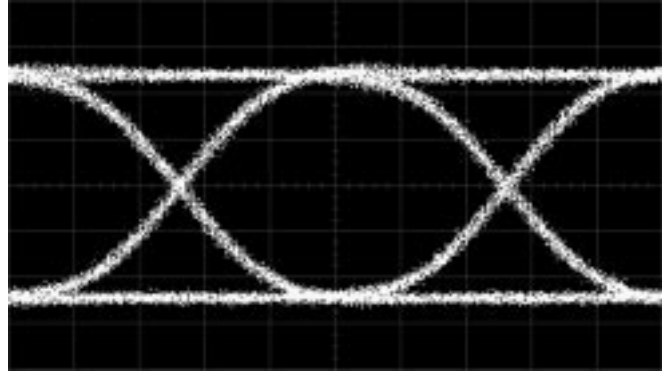

Waveform after passing LPF (9.953 Gbps)

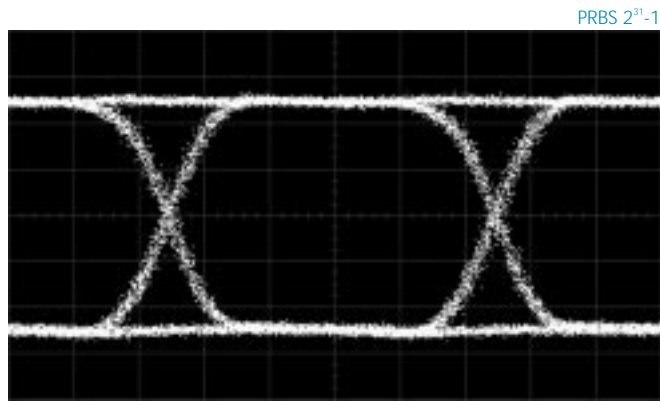

1 Vp-p output waveform (10 Gbps)

200 mV/div

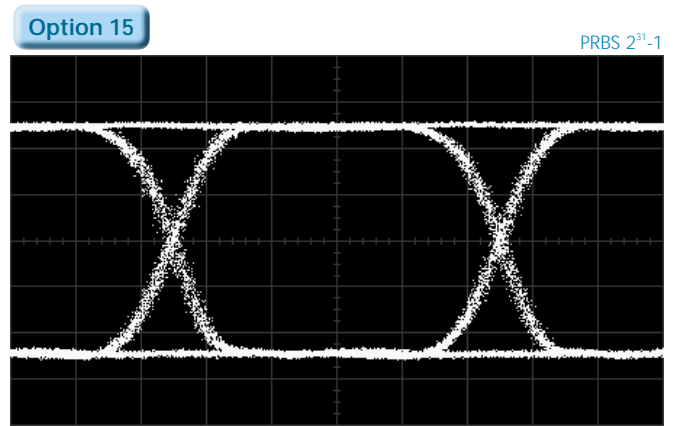

3 Vp-p output waveform (10 Gbps)

600 mV/div

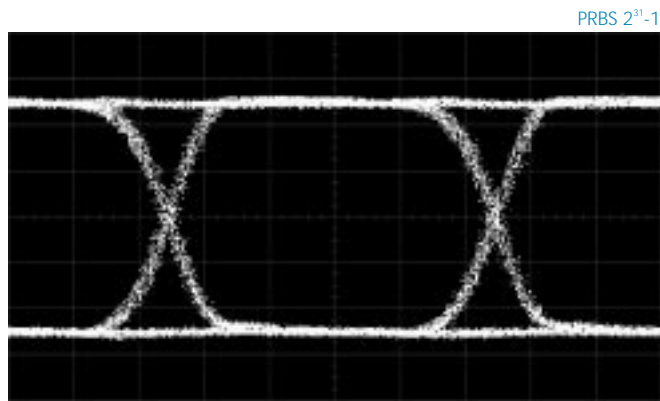

2 Vp-p output waveform (10 Gbps)

400 mV/div

Generation of SDH/SONET Frame Patterns Close to Actual Data

For Evaluation of Optical Transmission Equipment and E/O and O/E Modules

In O/E and E/O tests of the SDH/SONET system, testing at the frame level is required. In addition to the large WORD memory with 8 M-bit length, the D3186 Pulse Pattern Generator is provided with an optional function to insert WORD patterns in the header section of the STM frame and arbitrary PRBS in the payload section, realizing test patterns which are very close to actual data. Of course, the D3286 error detector can measure errors at the header and payload sections separately. In addition, the D3286 powerfully supports location of cause of errors by means of the frame synchronization function and specific area error measurement function.

Use this function key

• D3186

PATTERN MODE

PRBS WORD FRAME

PAYLOAD TYPE

WORD PRBS CID

• D3286

FRAME SYNC

MEASUREMENT MODE

OMIT INSERT TOTAL

OVHD PAYLOAD ALL

SPECIFIC OTHER ALL

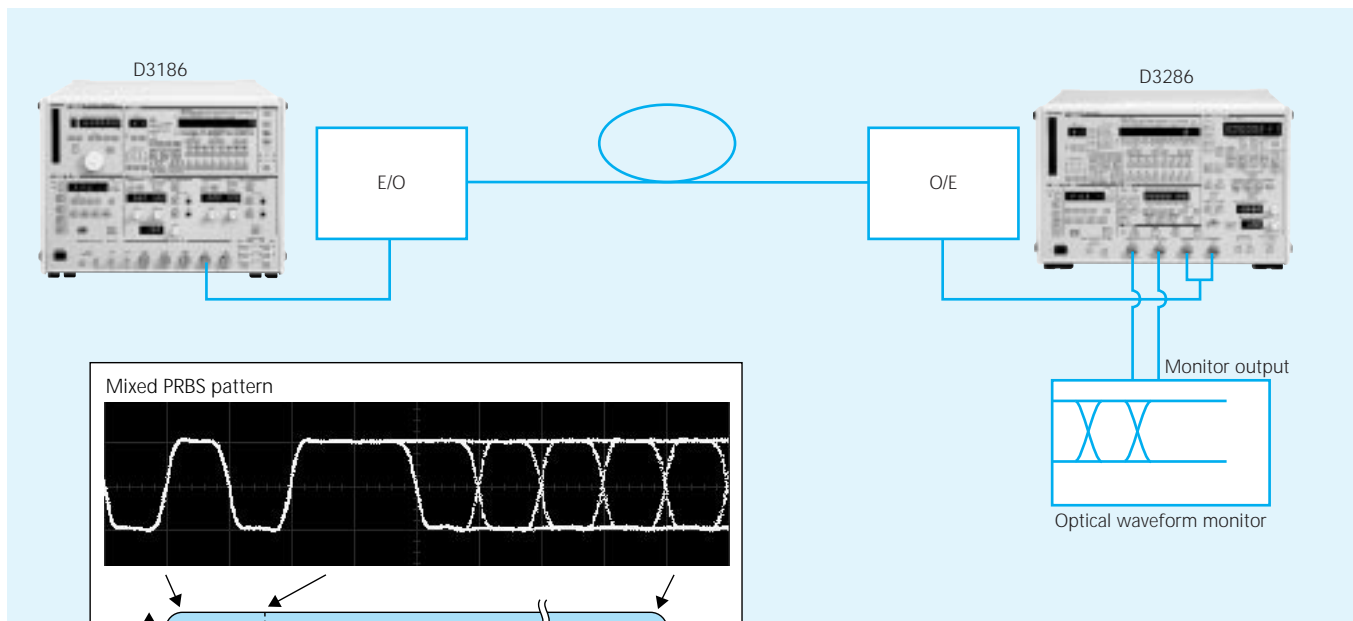

Generation of SDH/SONET frame pattern virtually identical with real data

Applicable to Fiber Loop Testing

In long-distance transmission testing, fiber loop-based transmission evaluation is performed. In this test, bit error measurement for irregular burst condition data is essential. The D3186 pulse pattern generator can output a burst signal based

on an external gate signal and the D3286 enables bit error measurement for burst condition data. This allows the fiber loop transmission test to be performed efficiently.

System configuration for fiber loop testing (Additional function is necessary. Please contact our sales office for detail.)

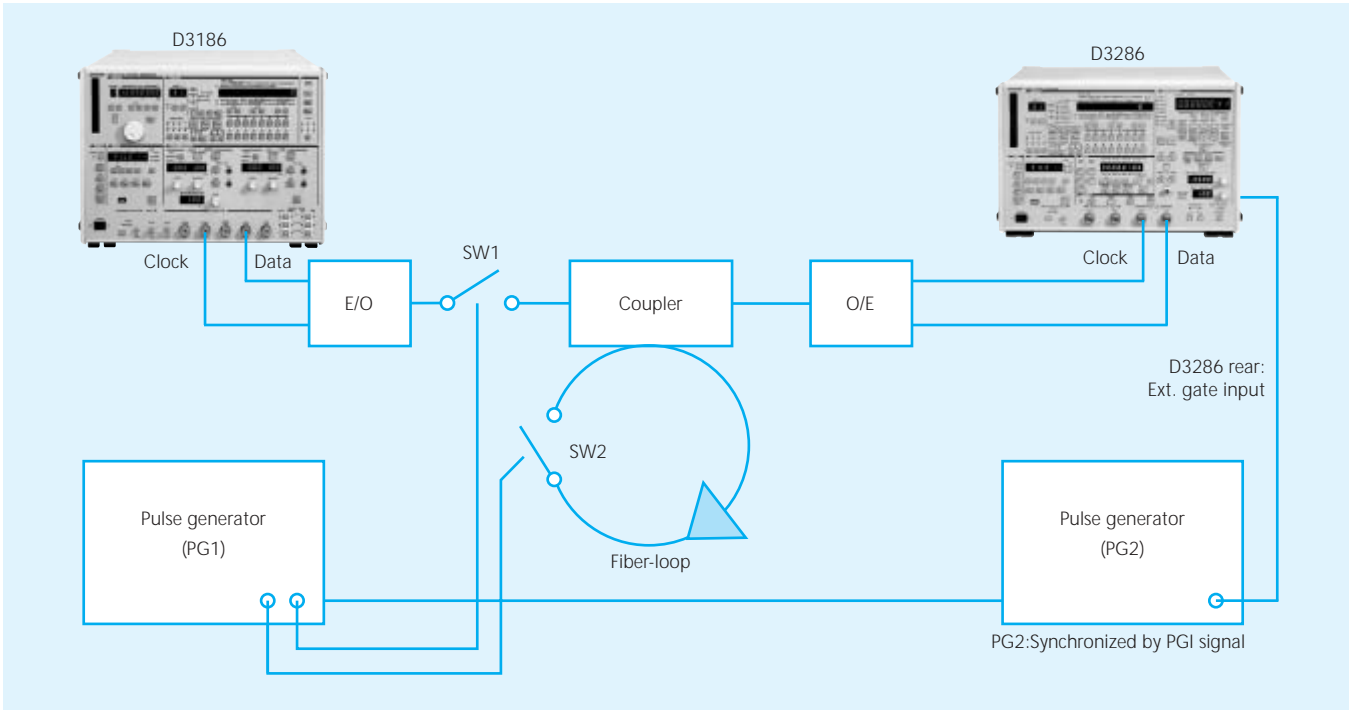
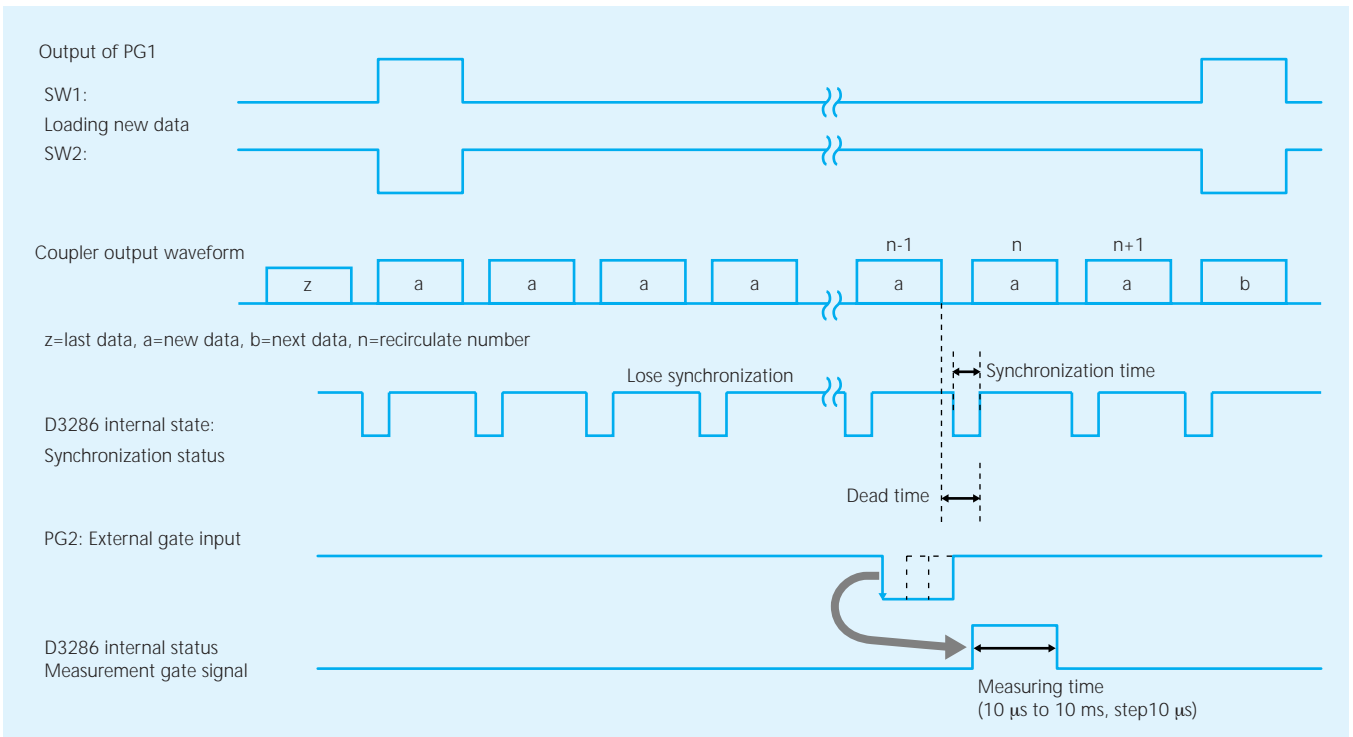
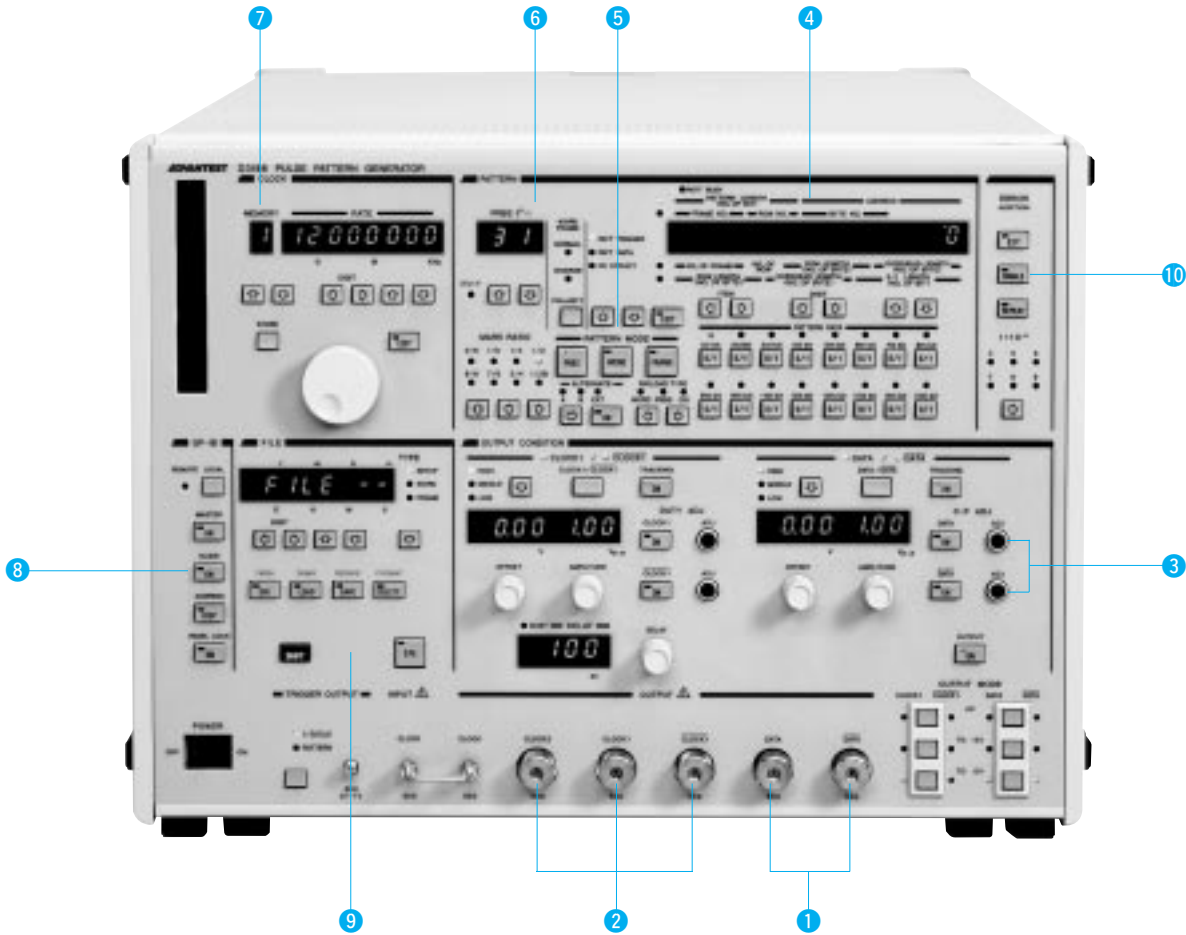

Diagram of timing



Front Panel Descriptions



D3186 Pulse Pattern Generator

① Data output (DATA, $\overline{\text{DATA}}$)

These connectors output the specified pattern in NRZ mode.

Amplitude range : 2 Vp-p, 3 Vp-p (option 15)

Offset range : ± 2 V

Tr/Tf : 30 ps or less

Jitter : 10 ps (typ.)

Overshoot, undershoot : 5% or less (typ.)

② Clock output (CLOCK1, $\overline{\text{CLOCK1}}$, CLOCK2)

CLOCK1, $\overline{\text{CLOCK1}}$,

These connectors output a clock signal with variable amplitude, offset, and delay.

Amplitude range : 2 Vp-p

Offset range : ± 2 V

CLOCK2

This connector outputs an AC-coupled clock signal.

Amplitude range : About 1 Vp-p fixed

③ Cross point adjustment

Used to adjust the cross point position for DATA and $\overline{\text{DATA}}$ outputs.

④ WORD pattern and frame pattern setup section

Used to set up WORD pattern and frame pattern. Selects up to 8 M-bit standard pattern memory allowing generation of 6 STM-64 frames.

⑤ Pattern mode setup section

Used to select the contents of the output pattern. WORD, PRBS, or FRAME (option 70) patterns can be selected.

⑥ Number-of-stages (N) selection key for PRBS

Applicable to 7 PRBS patterns with N of 7, 9, 10, 11, 15, 23, and 31.

⑦ Frequency setup section

Used to select the operating clock frequency. Optionally, a high-purity clock source can be incorporated (option 10, 13). Up to 16 setup frequencies can be registered in the internal memory.

⑧ Remote control

The standard GPIB interface is mounted. The MASTER/SLAVE function allows pattern editing in conjunction with the D3286 error detector.

⑨ Disk operation section

The standard FD drive allows operating conditions and pattern setup conditions to be stored in floppy disks.

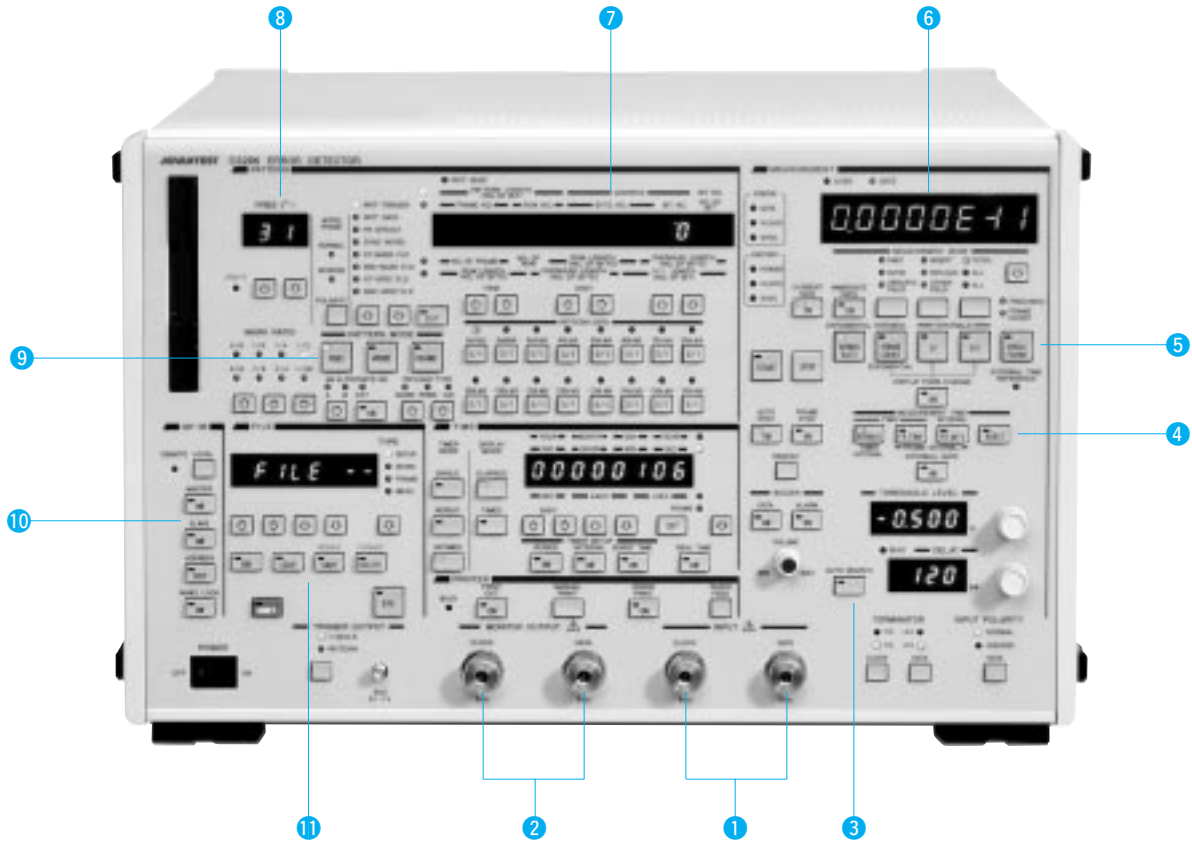

D3286 Error Detector

1 Data input section

• DATA

This input connector allows logic inversion.

Input amplitude : 0.1 to 2 Vp-p
 Threshold level setup range : -2.040 to +2.040 V
 Input sensitivity : 40 mV (typ.)

• CLOCK

Clock input connector

Input amplitude : 0.5 to 2 Vp-p
 Variable amount of delay : Variable range ± 400 ps with respect to data

2 Monitor output

Monitor output for input data and clock. Waveform monitoring is possible during bit error measurement.

3 Auto search function

Used to automatically adjust the amount of delay for clock input and the threshold level of data input with a touch of key, simplifying complicated operations.

4 Measurement time mode selection section

The measurement time mode can be set to one of three modes: frame time, frame interval, and burst. Applicable to burst measurement time in SDH frame measurement and fiber loop test.

5 Measurement results display function setup

ERROR RATE, ERROR COUNT, EI, EFI, or FREQ/F RAME can be selected.

6 Error measurement results display

Displays error measurement results with a display format dependent on the measurement function.

7 Pattern setup section

Used to edit data comparison pattern used in error measurement. The panel layout is the same as that of the D3186.

8 Number-of-stages (N) selection key for PRBS

Applicable to 7 PRBS patterns with N of 7, 9, 10, 11, 15, 23, and 31.

9 Pattern mode selection section

Used to select data comparison pattern from PRBS, WORD, and FRAME (option 70).

10 Remote control

The standard GPIB interface is mounted. The MASTER/SLAVE function allows pattern editing in conjunction with the D3186 Pulse Pattern Generator.

11 Disk operation section

The standard FD drive allows operating conditions and pattern setup conditions to be stored on floppy disks.

D3186 Specifications

Operating Clock

Operating clock source:	Internal clock (optional), external clock
Internal Clock (optional)	
Frequency range:	150 MHz to 12 GHz (Option 10) 150 MHz to 12.5 GHz (Option 13)
Frequency setting resolution:	1 kHz
Frequency stability:	±10 ppm/year
Output waveform:	Sine wave, approx. 1 Vp-p
Spurious:	-37 dBc (non harmonic wave)
SSB phase noise:	-70 dBc/Hz (10 kHz offset, 12 GHz carrier)
Frequency memory:	16 items
Load impedance:	50 Ω
Connector:	SMA (Jack)
Reference frequency output:	10 MHz, 1.5 Vp-p min., AC coupled, BNC
Reference frequency input:	10 MHz, 1.5 Vp-p min., AC coupled, BNC, automatically switched

External Clock

Frequency range:	150 MHz to 12 GHz 150 MHz to 12.5 GHz (Option 72)
Input level:	0.7 Vp-p to 1.5 Vp-p
Input waveform:	Sine wave
Main unit operating frequency range:	150 MHz to 12 GHz 150 MHz to 12.5 GHz (Option 72)

Patterns

Pattern Modes:	Can be selected from the 3 choices below. Pseudo random pattern (PRBS) Fully programmable pattern (WORD) Frame pattern (FRAME) (Option 70)
-----------------------	---

PRBS

Pattern length:	$2^N - 1$, where N can be selected from among
7 choices:	N=7, 9, 10, 11, 15, 23 or 31

Number of stages N and generating function:

Number of stages	Generating function	Applied Standard
7	$X^7 + X^6 + 1$	ITU-T recommended V.29
9	$X^9 + X^5 + 1$	ITU-T recommended V.52
10	$X^{10} + X^7 + 1$	
11	$X^{11} + X^9 + 1$	ITU-T recommended 0.152
15	$X^{15} + X^{14} + 1$	ITU-T recommended 0.151
23	$X^{23} + X^{18} + 1$	ITU-T recommended 0.151
31	$X^{31} + X^{28} + 1$	

Mark ratio:	Can be selected from among 1/2, 1/4, 1/8, 0/8, 1/2B, 3/4, 7/8, or 8/8 The patterns 1/2B, 3/4, 7/8, and 8/8 are the logical inversions of the patterns 1/2, 1/4, 1/8 and 0/8 respectively.
AND bit Shift count:	1 bit
Word	
Pattern length:	1 to 8,388,608 (2^{23}) bits (with ALTERNATE OFF) 1 to 4,194,304 (2^{22}) bits (with ALTERNATE ON)
Logical inversion:	Possible
ALTERNATE mode:	Can be turned ON/OFF; When ON, can be switched to either of 2 patterns, A or B
Switching control:	Internal, external switching possible
Internal switching:	Done by front panel keys or GPIB
External switching:	Done by external alternate input signal

FRAME (Option 70)

Payload format:	3 types below can be selected Fully programmable (WORD) Pseudo random (PRBS) 0/1 continuous pattern + PRBS (CID)
Frame structure:	
When payload format is WORD or PRBS:	
Number of frames:	1 to 8,192 (with ALTERNATE OFF) 1 to 4,096 (with ALTERNATE ON) 1 frame steps
Number of lines in 1 frame:	1 to 16 (1 line steps)
Number of bytes in 1 line:	44 to 32,768
Number of overhead bytes in 1 line:	4 to (number of bytes in 1 line - 40 bytes), 4 byte steps
When payload format is CID:	
Number of bites in 1 line:	40 to 32,768, 4 byte steps
Number of overhead bytes in 1 line:	36 to (number of bytes in 1 line - integer quotient of 36) × 36, 36 byte steps
Number of 0/1 continuous pattern bits:	0 to (number of bytes in 1 line - number of overhead bytes in 1 line) × 8 bits, 1 bit steps
Stage Number of PRBS:	7, discontinuous parts may exist
Logical inversion:	Possible
ALTERNATE mode:	Can be turned ON/OFF (only when payload type is WORD or PRBS); When ON, can be switched to either of 2 patterns, A or B
Switching control:	Internal, external switching possible
Internal switching:	Done by front panel keys or GPIB
External switching:	Done by external alternate input signal
Error Addition	
Error addition mode:	Repeat, single, external
Repeat:	Error ratio 1×10^{-N} , N=4 to 9, bit error is added at a set interval
Single:	1 bit error is added with every error addition command
External:	1 bit error is added with every falling edge of an external error addition pulse input
Main Outputs	
Number of outputs:	Data, 2 patterns (DATA, $\overline{\text{DATA}}$) Clock, 3 patterns (CLOCK1, $\overline{\text{CLOCK1}}$, CLOCK2)
Data Outputs (DATA, $\overline{\text{DATA}}$)	
Number of outputs:	2 patterns (DATA, $\overline{\text{DATA}}$, complementary)
Format:	NRZ
Coupling:	DC
Amplitude range:	0.5 Vp-p to 2 Vp-p, 10 mV steps (TO 0 V, AC) 0.6 Vp-p to 1 Vp-p, 10 mV steps (TO -2 V)
(Option 15) :	0.5 Vp-p to 3 Vp-p, 10 mV steps (TO 0 V) 0.5 Vp-p to 2 Vp-p, 10 mV steps (TO AC) 0.6 Vp-p to 1 Vp-p, 10 mV steps (TO -2 V)
Offset range:	-2 V to +2 V, 10 mV steps (TO 0 V) -1 V to -0.6 V, 10 mV steps (TO -2 V)
(Option 15) :	-1 V to +1 V, 10 mV steps (TO 0 V) -1 V to -0.6 V, 10 mV steps (TO -2 V)
Rise/fall time:	30 ps max.
Load terminal conditions:	Can be selected as either DC coupled TO 0 V, TO -2 V or AC coupled
Offset setting level:	Can be selected as either HIGH, MIDDLE or LOW
Cross point variable:	ON/OFF selectable GPIB selectable
Load impedance:	50 Ω
Connector:	2.92 mm (plug)

Clock Outputs (CLOCK1, $\overline{\text{CLOCK1}}$)

Number of outputs:	2 patterns (CLOCK1, $\overline{\text{CLOCK1}}$, complementary)
Format:	RZ
Coupling:	DC
Amplitude range:	0.5 V _{p-p} to 2 V _{p-p} , 10 mV steps (TO 0 V, AC) 0.6 V _{p-p} to 1 V _{p-p} , 10 mV steps (TO -2 V)
Offset range:	-2 V to +2 V, 10 mV steps (TO 0 V) -1 V to -0.6 V, 10 mV steps (TO -2 V) (HIGH level reference)
Rise/fall time:	30 ps max
Load terminal conditions:	Can be selected as either DC coupled TO 0 V, TO -2 V or AC coupled
Offset setting level:	Can be selected as either HIGH, MIDDLE or LOW
Duty ratio variable:	ON/OFF selectable
Variable delay range:	±400 ps, 1 ps steps (CLOCK2 output reference)
Load impedance:	50 Ω
Connector:	2.92 mm (plug)

Clock Output (CLOCK2)

Number of outputs:	1 pattern
Format:	RZ
Coupling:	AC (built-in DC blocking condenser)
Amplitude:	Approx. 1 V _{p-p} fixed
Offset:	0 V ± 0.1 V fixed (MIDDLE level reference)
Waveform:	Rectangular wave
Rise/fall time:	30 ps max
Load impedance:	50 Ω
Connector:	2.92 mm (plug)

Trigger Signal Output

Output Signal:	Can be selected as either clock synchronization or pattern synchronization
Clock synchronization (1/32 CLK):	Clock frequency 1/32 divided output
Pattern synchronization (PATTERN):	Varies output position to any position in 16 bit units
Output level:	HIGH level 0 V ± 0.2 V, LOW level -1 V ± 0.2 V
Load impedance:	50 Ω to 0 V
Connector:	SMA

Auxiliary Output

1/2 Clock Output

Format:	RZ
Coupling:	DC
Output level:	HIGH level, 0 V ± 0.2 V, LOW level -1 V ± 0.2 V
Load impedance:	50 Ω to 0 V
Connector:	SMA

1/4 Rate Output

Output bit rate:	1/4 operating clock frequency
Number of pattern outputs:	4 patterns
Number of clock outputs:	1 pattern
Output skew:	±150 ps max.
Output level:	HIGH level 0 V ± 0.25 V, LOW level -1 V ± 0.25 V
Load impedance:	50 Ω to 0 V
Connector:	SMA

Control Input

External Gate Input

Function:	Inhibits data output, inhibits at LOW level
Input level:	0 V/-1 V
Input pulse width:	At least 20 ns, or at least 64 x operating clock cycle, whichever is longer
Input impedance:	Approx. 50 Ω to 0 V
Connector:	BNC

External Alternate Input

Function:	In ALTERNATE mode, switches between patterns A and B; pattern A at HIGH level, Pattern B at LOW level
Input level:	0 V/-1 V
Input impedance:	Approx. 50 Ω to 0 V
Connector:	BNC

External Error Addition

Function:	When pattern error addition is external (EXT), 1 bit error is added for every fall edge of the input pulse
Input level:	0 V/-1 V
Input impedance:	Approx. 50 Ω to 0 V
Connector:	BNC

System Functions

Master/Slave Function

Function:	When used together with the D3286 Error Detector, allows the pattern settings of the D3186 and D3286 to be interlocked.
-----------	---

Panel Lock:

possible

External Clock Generator Control Function

Function:	When external clock generator (SG) is used, the frequency and output level are controlled from the D3186
Connection method:	Dedicated GPIB connector

Remote Control

Interface:	GPIB (IEEE 488-1978)
------------	----------------------

Calendar/Clock Function

Display:	Can be selected as either year/month/day/hour or day/hour/minute/second
File Function:	Built-in floppy disk drive
Functions:	Save, re-save, read in, erase and initialize
Saved data:	Operating conditions, pattern settings
Read in data:	Operating conditions, pattern settings
Disks used:	3.5 inch floppy disks, 720 KB (2DD), 1.2 MB (2HD), 1.4 MB (2HD)
Disk format:	MS-DOS® Rev. 4.0
File format:	Proprietary binary format

MS-DOS is a registered trademark of Microsoft Corporation.

General Specifications

Numerical value display:	Green 7 segment LED display
Set conditions memory:	After power has been ON for 12 hours, retained at least 2 weeks (backed up by secondary battery)
Operating temperature range:	0°C to +40°C +20°C to +30°C (Option 72)
Operating humidity range:	40% to 85% RH
Storage temperature range:	-20°C to +60°C
Storage humidity range:	30% to 85% RH (without condensation)
Power:	AC 100 V to 120 V, AC 220 V to 240 V (switches automatically) 48 to 63 Hz, sine wave
Power consumption:	550 VA max.
Mass:	42 kg max.
External dimensions:	Approx. 310 (H)×424 (W)×550 (D) mm

Standard Accessories

Name	Type	Stock No.	Quantity	Remarks
Power Cable	A01402	DCB-DD2428X01	1	
SMA-SMA Cable	DGM224-00700A	DCB-FF1211X01	7	
GPIO Cable	408JE-101	DCB-SS1076X02	1	
3 Pin- 2 Pin Converter Adapter For Power Plug	A09034	JCD-AL003EX03	1	
2.92 mm Adapter	02K121-K00S3	JCF-BJ001EX05	5	
User's Manual		JD3186 ED3186	1	Japanese English

D3286 Specifications

Operating Frequency

Operating Frequency Range: 150 MHz to 12 GHz
150 MHz to 12.5 GHz (Option 72)

Measuring Functions

Reference Measuring Functions:

Simultaneous measurement of 6 functions, 1 function can be selected for display

Error rate measurement

Error count measurement

Error interval (EI) measurement

Error free interval (EFI) measurement

Frequency measurement

Frame count measurement:

Frame count measurement can only be done when the pattern mode is FRAME, the payload format is WORD or PRBS, and the measuring time mode is FRAME TIME (FR. TIME) or FRAME INTERVAL (FR. INTV)

Synchronous measurement

Display Format:

Error rate measurement (1 type fixed)

Exponential format: Displays the number of error bits per number of input bits
Up to 5 digit mantissa + exponent

Error count measurement (2 types, 1 type can be selected for display)

Exponential format: Displays the number of error bits in exponential format
Up to 5 digit mantissa + exponent

Integer format: Displays the lowest 8 digits of the number of error bits as an integer

Error interval measurement (2 types, 1 type can be selected for display)

% format: Displays the number of error intervals per number of measured intervals as a fixed decimal point percentage
Up to 3 digit integer part + 4 digit decimal part

Number of interval format: Display the number of error intervals in exponential format
Up to 5 digit mantissa + exponent

Error free interval (EFI) measurement (2 types, 1 type can be selected for display)

% format: Displays the number of error free intervals as a fixed decimal point percentage
Up to 3 digit integer part + 4 digit decimal part

Number of interval format: Displays the number of error free intervals in exponential format
Up to 5 digit mantissa + exponent

Frequency measurement (1 type fixed)

Fixed decimal point: Displays the frequency of the input clock in MHz units in fixed decimal point format
Up to 5 digit integer part + 3 digit decimal part

Number of frames measurement (1 type fixed)

Exponent format: Converts the number of input bits to a number of frames and displays this number
Up to 5 digit mantissa + exponent

Error Measurement Mode: 3 groups can be selected, within each group three types of measurements can be done simultaneously, and one type displayed

Omission/Insertion Group
OMISSION: Displays the measured value of errors of the sort when logical data value of '0' is input when '1' is the expected value

INSERTION: Displays the measured value of errors of the sort when logical data value of '1' is input when '0' is the expected value

TOTAL: Displays the measured value of the sum of OMISSION and INSERTION type errors (all errors).

Overhead/Payload Group

Can only be selected when the pattern mode is FRAME

OVERHEAD: Displays the measured value of errors in the overhead part.

PAYLOAD: Displays the measured value of errors in the payload part.

ALL: Displays the measured value of sum of the errors in the overhead part and payload part (all frame errors).

Specific field group

Can only be selected when the pattern mode is WORD or FRAME

SPECIFIC FIELD: Displays the measured value of errors within a specified specific field.

OTHER FIELD: Displays the measured value of errors within the fields other than the specified specific field.

ALL: Displays the measured value of the sum of the errors in the specific field and the other fields (all pattern errors)

Midway Results Display: ON/OFF selectable

Threshold EF/EFI Measurement:

Measured results can only be given as printer output and file record Measures simultaneously with the reference measurement function

Error Performance Measurement:

Measured results can only be given as printer output and file record Measurement items (the 5 items below are measured simultaneously with the reference measurement function)
ES: Errored Seconds
EFS: Error Free Seconds
SES: Severely Errored Seconds
US: Unavailable Seconds
DM: Degraded Minutes

Measurement Control

START: Starts simultaneous measurement of all measuring functions, or measurement interrupt and re-start. Can be done with front panel keys, GPIB or external gate input signal.

STOP: Stops simultaneous measurement of all measuring functions. Can be operated through front panel keys, GPIB built-in timer, or external gate input signal.

Measuring Time Mode: NORMAL:	Any of 4 types can be selected Sets measurement interval in seconds units, measurement period in day/hour/minute/second units.
FR. TIME:	Can only be selected when pattern mode is FRAME. Measuring interval is set in number of frame units and measuring period is set in day/hour/minute/second units.
FR. INTV:	Can only be selected when pattern mode is FRAME. Measuring interval is set in number of frame units and measuring period is set in number of measuring interval units.
BURST:	Each time pattern synchronization is established during the period from measuring start to measuring end, only the area set by the burst timer is measured.
Mask Function:	Can only be selected when pattern mode is WORD or FRAME. Synchronization and measurement are done ignoring errors in the specified mask field.
Pattern Synchronization	
Auto synchronization:	ON/OFF selectable When ON, re-synchronization is done automatically when the error rate is equal to or greater than the prescribed value.
Frame synchronization:	Can be turned ON or OFF when pattern mode is FRAME or WORD. Set OFF during PRBS. When ON, the specified hunting pattern is searched and high speed pattern synchronization is done.
Re-synchronization:	Command can be given using front panel keys or GPIB.
Measurement Conditions Display Lamp	
GATE:	Lights during measurement.
OVER:	Lights when measurement results overflow.
Error Alarm Display Lamp	
DATA error:	Lights when a 1 or more bit error is detected. Goes out when error is no longer detected.
CLOCK error:	Lights when the input clock fails or frequency is too low. Goes out when normal clock is input.
SYNC error:	Lights when there is a pattern synchronization error. Goes out when pattern synchronization is established.
History Display Lamp	
POWER fail:	Lights after power is restored after a power failure. Stays lit until the next measurement starts.
CLOCK error:	Lights when the input clock fails or frequency is too low. After the error is recovered, lights until the next measurement starts.
SYNC error:	Lights when there is a pattern synchronization error. After the error is recovered, lights until the next measurement starts.
Buzzer	
Error:	Sounds when there is a DATA error. Can be set to ON/OFF. Volume variable (same as alarm volume).
Alarm:	Sounds when there is a CLOCK or SYNC error. Can be set to ON/OFF. Volume variable (same as error volume).

Measurement Input	
Data Input	
Input format:	DC termination, DC coupling
Code:	NRZ
Polarity:	Logical inversion possible
Input amplitude:	0.1 V _{p-p} to 2 V _{p-p}
Threshold level:	Setting range -2.040 V to + 2.040 V Setting resolution 0.001 V steps (with 0 V terminal voltage) Setting range -1.850 V to -0.750 V Setting resolution 0.001V steps(with -2 V terminal voltage)
Terminal voltage:	-2 V/0 V (GND)
Input impedance:	Approx. 50 Ω
Connector:	2.92 mm (plug)
Clock Input	
Input format:	DC termination, AC coupling
Duty ratio:	50% ±5%
Polarity:	Identified at rise edge
Variable delay:	±400 ps 1 ps steps (at monitor output)
Input amplitude:	0.5 V _{p-p} to 2 V _{p-p}
Terminal voltage:	-2 V/0 V (GND)
Input impedance:	Approx. 50 Ω
Connector:	2.92 mm (plug)
Input waveform:	Sine wave or rectangular wave
Auto Search Function	
Automatically finds the optimum values for data input threshold level and clock input delay.	
Trigger Signal Output	
Output Signal:	Can be selected as either clock synchronization or pattern synchronization
Clock synchronization (1/32 CLK):	Clock frequency 1/32 divided output
Pattern synchronization (PATTERN):	Varies output position to any position in 16 bit units
Output level:	HIGH level 0 V ±0.2 V, LOW level -1 V ±0.2 V
Load impedance:	50 Ω to 0 V
Connector:	SMA
Auxiliary Output	
Monitor Output	
Data monitor:	Outputs data input through amplifier
Load impedance:	50 Ω to 0 V
Connector:	2.92 mm (plug)
Clock monitor:	Outputs clock input through amplifier and variable delay line
Load impedance:	50 Ω to 0 V
Connector:	2.92 mm (plug)
Error Output	
Direct output	
Rate:	1/32 of clock input
Signal form:	32 phase logical sum
Code:	RZ
Output voltage:	HIGH level -0.0 ± 0.3 V LOW level -1.0 ± 0.3 V
Load impedance:	50 Ω to 0 V
Connector:	SMA (jack)
Stretched output	
Level:	TTL positive pulse
Pulse width:	Approx. 100 ns
Load impedance:	50 Ω to 0 V
Connector:	BNC (jack)

Control Input

External Gate Input

Function: Controls measurement start/stop
Input level: 0 V/-1 V
Input impedance: Approx. 50 Ω to 0 V
Connector: BNC (jack)

External Alternate Input

Function: Switches between patterns A and B in alternate mode. Pattern A at HIGH level, pattern B at LOW level.
Input level: 0 V/-1 V
Input impedance: Approx. 50 Ω to 0 V
Connector: BNC (jack)

Patterns

Same as for the D3186 Pulse Pattern Generator

Timer/Clock

Timer/Clock Display

ELAPSED: Displays the elapsed time since the start of measurement.
TIMED: Displays the remaining time until the end of measurement.
PERIOD: Displays or sets the measuring period from the start of measurement until the end.
INTERVAL: Displays or sets the measuring cycle.
BURST TIME: Displays or sets the measuring time per signal burst when the measuring time mode is BURST.
REAL TIME: Displays or sets real time as year/month/day/hour or day/hour/minute/second.

Timer Mode

SINGLE: When the set period of measurement has elapsed, the measurement is stopped.
REPEAT: When the set period of measurement has elapsed, a new measurement is begun. The sequence is repeated until a command to stop is received.
UNTIMED: Measurement continues regardless of the set measuring period, until the command to stop is given.

Time Reference Clocks:

Internal clock stability: Internal, external, selected automatically
10 ppm/year
External clock input: 10 MHz, 1 V_{p-p}, AC coupled
Connector: BNC (Jack)

System Functions

Printer: Measurement results can be output to an external printer

External printer interface:

Standard specification: Centronics specification
Connector: 36 pin micro ribbon

File Function: Same as for the D3186 Pulse Pattern Generator and possible to save measurement results
Measurement results: MS-DOS[®] text format

Remote Control

Interface: GPIB (IEEE 488-1978)

Master/Slave Function

Function: When used together with the D3186 Pulse Pattern Generator, allows the pattern settings of the D3186 and D3286 to be interlocked.

Connection method: Connected by GPIB cable, through each GPIB connector

Panel Lock:

Can lock all condition settings except power ON/OFF, panel lock ON/OFF, GPIB Local return, rear panel DIP switch settings, and buzzer volume level.

General Specifications

Numerical value display: Green 7 segment LED display
Set conditions memory: After power has been ON for 12 hours, retained at least 2 weeks (backed up by secondary battery)
Operating temperature range: 0°C to +40°C
+20°C to +30°C (Option 72)
Operating humidity range: 40% to 85% RH
Storage temperature range: -20°C to +60°C
Storage humidity range: 30% to 85% RH (without condensation)
Power: AC 100 V to 120 V, AC 220 V to 240 V (switches automatically) 48 to 63 Hz, sine wave
Power consumption: 500 VA max.
Mass: 32 kg max.
External dimensions: Approx. 266 (H)×424 (W)×550 (D) mm

Standard Accessories

Name	Type	Stock No.	Quantity	Remarks
Power Cable	A01402	DCB-DD2428X01	1	
SMA-SMA Cable	DGM224-00700A	DCB-FF1211X01	3	
GPIB Cable	408JE-101	DCB-SS1076X02	1	
3 Pin - 2 Pin Converter Adapter For Power Plug	A09034	JCD-AL003EX03	1	
2.92 mm Adapter	02K121-K00S3	JCF-BJ001EX05	4	
User's Manual		JD3286 ED3286	1	Japanese English

Please be sure to read the manual of product thoroughly before using the products. Specifications may change without notification.

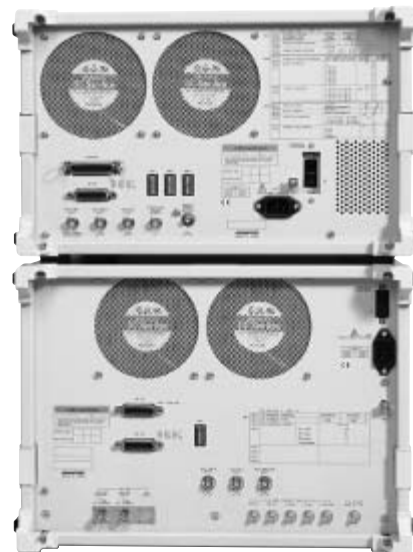

ADVANTEST CORPORATION
Shinjuku-NS building, 4-1
Nishi-Shinjuku 2-chome
Shinjuku-ku, Tokyo 163-0880,
Japan
Tel: +81-3-3342-7500
Fax: +81-3-5322-7270
<http://www.advantest.co.jp>

Advantest (Singapore) Pte. Ltd.
438A Alexandra Road,
#8-03/06 Alexandra Technopark
Singapore 119967
Tel: +65-274-3100
Fax: +65-274-4055

Tektronix Inc. (North America)
P. O. Box 500 Howard Vollum
Industrial Park Beaverton,
Oregon 97077-0001 U. S. A.
Tel: +1-800-426-2200
Fax: +1-503-627-4090

Rohde & Schwarz
Engineering and Sales GmbH
(Europe)
Mühlendorfstraße 15
D-81671 München, Germany
P.O.B. 80 14 29
D-81614 München, Germany
Tel: +49-89-4129-13711
Fax: +49-89-4129-13723