



ROHDE & SCHWARZ

Instruments
Division

Operating Manual

SPECTRUM ANALYZER

FSB

848.0020.52

Printed in the Federal
Republic of Germany

Qualitätszertifikat

Certificate of quality

Certificat de qualité

Certified Quality System
ISO 9001

Certified Environmental System
ISO 14001

Sehr geehrter Kunde,

Sie haben sich für den Kauf eines Rohde&Schwarz-Produktes entschieden. Hiermit erhalten Sie ein nach modernsten Fertigungsmethoden hergestelltes Produkt. Es wurde nach den Regeln unseres Qualitätsmanagementsystems entwickelt, gefertigt und geprüft. Das Rohde&Schwarz-Qualitätsmanagementsystem ist u.a. nach ISO9001 und ISO14001 zertifiziert.

Der Umwelt verpflichtet

- ▮ Energie-effiziente, RoHS-konforme Produkte
- ▮ Kontinuierliche Weiterentwicklung nachhaltiger Umweltkonzepte
- ▮ ISO 14001-zertifiziertes Umweltmanagementsystem

Dear Customer,

You have decided to buy a Rohde&Schwarz product. You are thus assured of receiving a product that is manufactured using the most modern methods available. This product was developed, manufactured and tested in compliance with our quality management system standards. The Rohde&Schwarz quality management system is certified according to standards such as ISO9001 and ISO14001.

Environmental commitment

- ▮ Energy-efficient products
- ▮ Continuous improvement in environmental sustainability
- ▮ ISO 14001-certified environmental management system

Cher client,

Vous avez choisi d'acheter un produit Rohde&Schwarz. Vous disposez donc d'un produit fabriqué d'après les méthodes les plus avancées. Le développement, la fabrication et les tests respectent nos normes de gestion qualité. Le système de gestion qualité de Rohde&Schwarz a été homologué, entre autres, conformément aux normes ISO9001 et ISO14001.

Engagement écologique

- ▮ Produits à efficience énergétique
- ▮ Amélioration continue de la durabilité environnementale
- ▮ Système de gestion de l'environnement certifié selon ISO 14001

Customer Support

Technical support – where and when you need it

For quick, expert help with any Rohde & Schwarz equipment, contact one of our Customer Support Centers. A team of highly qualified engineers provides telephone support and will work with you to find a solution to your query on any aspect of the operation, programming or applications of Rohde & Schwarz equipment.

Up-to-date information and upgrades

To keep your instrument up-to-date and to be informed about new application notes related to your instrument, please send an e-mail to the Customer Support Center stating your instrument and your wish. We will take care that you will get the right information.

Europe, Africa, Middle East

Phone +49 89 4129 12345
customersupport@rohde-schwarz.com

North America

Phone 1-888-TEST-RSA (1-888-837-8772)
customer.support@rsa.rohde-schwarz.com

Latin America

Phone +1-410-910-7988
customersupport.la@rohde-schwarz.com

Asia/Pacific

Phone +65 65 13 04 88
customersupport.asia@rohde-schwarz.com



Address List

Headquarters, Plants and Subsidiaries

Headquarters

ROHDE&SCHWARZ GmbH & Co. KG
Mühlendorfstraße 15 · D-81671 München
P.O.Box 80 14 69 · D-81614 München

Phone +49 (89) 41 29-0
Fax +49 (89) 41 29-121 64
info.rs@rohde-schwarz.com

Plants

ROHDE&SCHWARZ Messgerätebau GmbH
Riedbachstraße 58 · D-87700 Memmingen
P.O.Box 16 52 · D-87686 Memmingen

Phone +49 (83 31) 1 08-0
+49 (83 31) 1 08-1124
info.rsmb@rohde-schwarz.com

ROHDE&SCHWARZ GmbH & Co. KG
Werk Teisnach
Kaikenrieder Straße 27 · D-94244 Teisnach
P.O.Box 11 49 · D-94240 Teisnach

Phone +49 (99 23) 8 50-0
Fax +49 (99 23) 8 50-174
info.rsdt@rohde-schwarz.com

ROHDE&SCHWARZ závod
Vimperk, s.r.o.
Location Spidrova 49
CZ-38501 Vimperk

Phone +420 (388) 45 21 09
Fax +420 (388) 45 21 13

ROHDE&SCHWARZ GmbH & Co. KG
Dienstleistungszentrum Köln
Graf-Zeppelin-Straße 18 · D-51147 Köln
P.O.Box 98 02 60 · D-51130 Köln

Phone +49 (22 03) 49-0
Fax +49 (22 03) 49 51-229
info.rsd@rohde-schwarz.com
service.rsd@rohde-schwarz.com

Subsidiaries

R&S BICK Mobilfunk GmbH
Fritz-Hahne-Str. 7 · D-31848 Bad Münder
P.O.Box 20 02 · D-31844 Bad Münder

Phone +49 (50 42) 9 98-0
Fax +49 (50 42) 9 98-105
info.bick@rohde-schwarz.com

ROHDE&SCHWARZ FTK GmbH
Wendenschloßstraße 168, Haus 28
D-12557 Berlin

Phone +49 (30) 658 91-122
Fax +49 (30) 655 50-221
info.ftk@rohde-schwarz.com

ROHDE&SCHWARZ SIT GmbH
Am Studio 3
D-12489 Berlin

Phone +49 (30) 658 84-0
Fax +49 (30) 658 84-183
info.sit@rohde-schwarz.com

R&S Systems GmbH
Graf-Zeppelin-Straße 18
D-51147 Köln

Phone +49 (22 03) 49-5 23 25
Fax +49 (22 03) 49-5 23 36
info.rssys@rohde-schwarz.com

GEDIS GmbH
Sophienblatt 100
D-24114 Kiel

Phone +49 (431) 600 51-0
Fax +49 (431) 600 51-11
sales@gedis-online.de

HAMEG Instruments GmbH
Industriestraße 6
D-63533 Mainhausen

Phone +49 (61 82) 800-0
Fax +49 (61 82) 800-100
info@hameg.de

Locations Worldwide

Please refer to our homepage: www.rohde-schwarz.com

- ◆ Sales Locations
- ◆ Service Locations
- ◆ National Websites

Important Note !

When changing the power fuses, please notice the new values:

RF-Unit FSA, FSAS, FSAC, FSAD, FSB, FSBS, FSBC, FSM, FSMS, ESAI, ESBI, all Display-Units:

220/240 V: IEC127-T3,15L/250 V Part. No. 009.0584

100/120 V: IEC127-T5L/250 V Part. No. 009.0603

RF-Unit FSMS26, ESMI

220/240 V: IEC127-T4L/250 V Part. No. 009.0590

100/120 V: IEC127-T6,3L/250 V Part. No. 009.0610

Contents of FSB Manual

Operating Manual

- 1 Specifications
- 2 Operation
- 3 Performance Test

Service Manual

Volume 1

- 4 Service Instructions for Complete Instrument

Volume 2

- 5 Service Instructions RF Unit
- 6 Service Instructions for Modules of RF Unit

	Order No.	Index
Attenuator	849.3517.00	1
RF Module	848.9511.02	2
Preamplifier 3rd IF	848.8009.02	3
YIG Synchronization	849.2010.02	4
YIG Pretune + YIG Oscillator	848.6506.02	5
2nd LO/3rd Converter	848.3507.02	6
M Synthesizer	807.0010.02	7

Volume 3

- 6 Service Instructions for Modules of RF Unit

N Synthesizer	849.1014.02	1
Summing Loop	807.4015.02	2
Sweep Synthesizer	807.5011.02	3
Reference 2	807.3019.02	4
Reference 1	848.5000.02	5
Frequency Processor	810.3400.02	6
Interface	807.7014.02	7
Keyboard	806.4811.02	8
Power Supply, A21	808.4819.03	9
Power Supply, A22	808.4519.03	10

Contents

	Page
1	Specifications
	Data Sheet
2	Operation 2.1
2.1	Explanation of Operating Controls 2.1
2.1.1	Front Panel of Display Unit 2.1
2.1.2	Front Panel of RF Unit 2.3
2.1.3	Rear Panel of Display Unit 2.7
2.1.4	Rear Panel of RF Unit 2.9
2.2	Preparation for Use 2.12
2.2.1	Fitting the Instrument Handles 2.12
2.2.2	Adjustment of Power Supply/Fuse Replacement 2.12
2.2.3	Mechanical Connection of the two Units 2.12
2.2.4	Electrical Connection of the two Units 2.12
2.2.5	Installation in 19-inch Rack 2.13
2.3	Manual Operation 2.14
2.3.1	Switching On and Subsequent Response of Instrument 2.14
2.3.2	General Operation Concept 2.14
2.3.3	Explanation of Terms 2.15
2.3.4	Menu Operation Structure 2.15
2.3.4.1	Schematic Representation of Hierarchy 2.16
2.3.4.2	Schematic Representation of Menu Operation 2.16
2.3.4.3	Width Control of a Menu 2.17
2.3.4.4	Possible Status of Softkeys 2.17
2.3.4.5	Data Input/Data Variation 2.17
2.3.4.6	Changing the Softkey Labelling Using an External Keyboard 2.19
2.3.5	MODE 2.20
2.3.6	ANALYZER 2.21
2.3.6.1	Theory of Operation 2.21
2.3.6.2	Explanation of Screen Inscriptions 2.25
2.3.6.3	PRESET 2.26
2.3.6.4	Explanation of Hardkey Functions and Menus 2.27
2.3.7	RECEIVER 2.71
2.3.7.1	Theory of Operation 2.71
2.3.7.2	RECEIVER Menu 2.72
2.3.8	SETUP 2.79
2.3.8.1	Theory of Operation 2.79
2.3.8.2	SETUP Menu 2.79

	Page
2.4	Remote Control of Instrument 2.83
2.4.1	IEC Bus 2.83
2.4.1.1	Setting the Device Address 2.84
2.4.1.2	Local/Remote Switchover 2.84
2.4.1.3	Interface Messages 2.85
2.4.1.3.1	Universal Commands 2.85
2.4.1.3.2	Addressed Commands 2.85
2.4.1.4	Device Messages 2.87
2.4.1.4.1	Commands Received by the Analyzer in Listener Mode (Controller to Device Messages) 2.87
2.4.1.4.2	Messages Sent by the Analyzer in Talker Mode (Device to Controller Messages) 2.89
2.4.1.4.3	Device-independent Commands (Common Commands) 2.90
2.4.1.4.4	Device-specific Commands 2.94
2.4.1.5	Service Request and Status Register 2.112
2.4.1.6	Resetting of Device Functions 2.119
2.4.1.7	Command Processing Sequence and Synchronization 2.120
2.4.1.8	Error Handling 2.120
2.4.1.9	Programming Examples 2.121
2.4.1.10	Trace Record 2.131
2.5	Interfaces 2.145
2.5.1	IEC Bus Interface 2.145
2.5.1.1	Interface Characteristics 2.145
2.5.1.2	Pin Assignment and Signal Designations 2.145
2.5.2	Parallel Printer Interface (Centronics) 2.146
2.5.2.1	Interface Characteristics 2.146
2.5.2.2	Pin Assignment and Signal Designations 2.146
2.5.2.3	Signal Timing Sequence 2.146
2.5.3	Serial Interface 2.147
2.5.3.1	Interface Characteristics 2.147
2.5.3.2	Interface Data 2.147
2.5.3.3	Pin Assignment and Signal Designations 2.147
2.5.4	External Floppy Interface 2.148
2.5.4.1	Pin Assignment and Signal Description 2.148
2.5.5	External Video Interface 2.149
2.5.5.1	Interface Description 2.149
2.5.5.2	Signal Timing Sequence 2.149
2.5.6	Keyboard Interface 2.151
2.5.6.1	Interface Characteristics 2.151
2.5.6.2	Connector 2.151
2.5.6.3	Signal Timing Sequence 2.151
2.5.7	USER PORT 2.152
2.5.7.1	Interface Characteristics 2.152
2.5.7.2	Pin Assignment and Signal Designations 2.152
2.5.7.3	Electrical Characteristics 2.152
2.5.8	PROBE CODE 2.153
2.5.8.1	Interface Characteristics 2.153
2.5.8.2	Pin Assignment and Signal Designations 2.153

Contents

	Page
3	Performance Test 3.1
3.1	Required Measuring Equipment and Accessories 3.1
3.2	Checking the Rated Specifications 3.3
3.2.1	Frequency Accuracy 3.3
3.2.1.1	Internal Reference Frequency 3.3
3.2.1.2	Frequency Accuracy According to Data Sheet 3.4
3.2.1.3	Span Accuracy 3.5
3.2.1.4	External Reference 3.5
3.2.2	Amplitude Accuracy 3.5
3.2.2.1	Calibration Output 100 MHz 3.5
3.2.2.2	RF Frequency Response with Fixed (10 dB) RF Attenuation 3.6
3.2.2.3	RF Frequency Response with RF Attenuation > 10 dB 3.6
3.2.2.4	Level Display Linearity in Logarithmic Level Ranges 3.6
3.2.2.5	Level Display Linearity in Linear Level Range 3.7
3.2.2.6	IF Level Linearity as a Function of Input Mixer Level 3.7
3.2.2.7	Level Display Accuracy in Logarithmic Level Ranges at RF Attenuation > 10 dB 3.8
3.2.2.8	Return Loss of Input 3.8
3.2.2.9	Thermal Noise 3.9
3.2.2.10	Sensitivity at Bottom End of Frequency Range 3.9
3.2.2.11	Resolution Filters 3.9
3.2.3	Spurious Signals 3.9
3.2.3.1	Spurious Signals with Terminated Input 3.9
3.2.3.1.1	Local Oscillator Suppression at 0 Hz 3.9
3.2.3.1.2	Further Internal Oscillators 3.10
3.2.3.1.3	Spurious Signals as Result of Mixing Procedures 3.10
3.2.3.2	Spurious Signals with One or More Input Signals 3.10
3.2.3.2.1	Spectral Purity of Internal Oscillators 3.10
3.2.3.2.2	Variable-frequency Spurious Signals in Oscillator Sidebands 3.11
3.2.3.2.3	Spurious FM 3.11
3.2.3.2.4	Harmonics Resulting from Single Input Signal 3.11
3.2.3.2.5	Spurious Resulting from Intermodulation of Two Input Signals 3.12
3.2.3.2.6	IF Rejection 3.13
3.2.3.2.7	Image Frequency Rejection 3.13
3.3	Performance Test Report 3.14
3.4	Maintenance 3.20
3.4.1	Cleaning 3.20
3.4.2	Mechanical Maintenance 3.20
3.4.3	Electrical Maintenance 3.20
3.4.4	Battery Replacement 3.20
3.4.5	Programming the EPROM for Frequency Response Correction 3.21
3.5	Storage 3.23

Supplement to the Data Sheets:

ESAI / ESBI / ESMI (PD 757.1302.21)

FSA (PD 756.4808.23)

FSAC (PD 756.7142.22)

FSAD (PD 756.6175.21)

FSAS (PD 756.7307.22)

FSB (PD 756.8384.21)

FSBC (PD 756.6723.21)

FSBS (PD 756.9216.21)

FSM (PD 756.7120.21)

FSMS (PD 757.0106.21)

FSMS26 (PD 757.0858.21)

The following function deviates from data sheet specifications:

The unit can be operated from 220 V \pm 10% or 230 V +6%/-14%.

In the course of harmonization, the AC supply voltage labelling on the rear panel was changed to 230 V.

No design modifications were made on the unit itself.

The power transformer is rated for 220 V.



Supplement to Data Sheet FSB

The specifications given in the data sheet PD 756.8384.21 have been modified as follows:

Residual FM

Span \leq 5 MHz < 3 Hz PP/2 in 10 s
(RBW = 10 Hz, VBW = 10 Hz)

Measurement error

RF frequency response
 $f_e \leq 40$ MHz $\leq \pm 1$ dB, ref. level > -30 dBm
(RF attenuation = 10 dB and DC coupling, ref. to 100 MHz)

Resolution bandwidth switching
calibrated RBW < 10 Hz $< \pm 1$ dB

AC/DC switching of input coupling $f > 3$ GHz (-0.3 dB/GHz + 0.4 dB)

Spurious responses

Internal, without input signal
Input terminated with 50Ω
RF attenuation = 0 dB, $f < 1$ MHz, $f > 4.7$ GHz, $f = 1.585$ GHz to ≤ -100 dBm

FM demodulator

Data given are valid for signal levels between 0 and -30 dBm below the ref. level
VBW = 10 kHz, signal-to-noise ratio > 60 dB

Supplements A to I to Operating Manual FSA, FSB, FSM, ESAI (from Firmware Version 2.30)

New Functions (for all Models)

- Tolerance lines can now also be used in the time range (Tolerance Line menu).
- 4-quadrant plot is now feasible in the Plot menu.



Call of a submenu limiting plotter output to a quarter of the output area used.



Limit plotter output to a partial quadrant of the output area.



Output in the upper right-hand quadrant.



Switch off partial quadrant output. Subsequently the complete output area is used for plotter output.



Output in the lower left-hand quadrant.

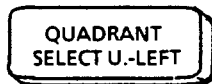

Output in the upper left-hand quadrant.



Output in the lower right-hand quadrant.

IEC bus command:

Command	Data	Units	Meaning
PLOT:QUADRANT	ON OFF U_LEFT U_RIGHT L_LEFT L_RIGHT	--	Plotting quadrant on Plotting quadrant off Upper left-h. quadrant Upper right-h. quadrant Lower left-h. quadrant Lower right-h. quadrant

- Selectable printer formfeed (settable in the Setup menu)

IEC bus command:

Command	Data	Units	Meaning
PRINT:FORMFEED	ON OFF	-- --	Formfeed on Formfeed off

New Function (only for FSA, FSB)

- AC/DC key as a menu

Using this menu coupling of the input can be switched between AC and DC. The selected type of coupling is indicated by means of LEDs on the front panel.

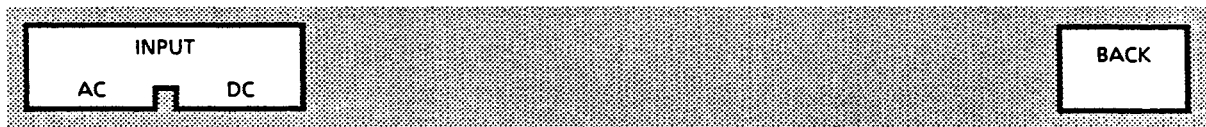

New Function (only for EMI Receiver)

- Scan Adjust (EMI Receiver: Config. Table menu)



This function serves to adopt start and stop frequency of the active configuration table as start and stop frequency of the receiver.

IEC bus command:

Command	Data	Units	Meaning
SCAN:ADJUST	--	--	Adopting start and stop frequency from Configuration Table

Calling the Transducer Table is now also possible in the EMI main menu. Use is the same as in the TRANSD.FACTOR submenu (cf. SPECIAL FUNCTIONS).

- Max Hold (Scan mode: Detector Trace menu)



With every scan the, in each case, maximum value is taken from both the new measured value and the TRACE data stored up to now and entered into the TRACE memory. Pressing the softkey again clears the TRACE memory.

- Scan mode
Switch-over of time constants for AVG and RMS detectors is now performed as a function of bandwidth and measuring time instead of measurement frequency (in supplementary menus Trace and Test Marker).

● Additional bit "Last Block Transmitted" in the ERD register

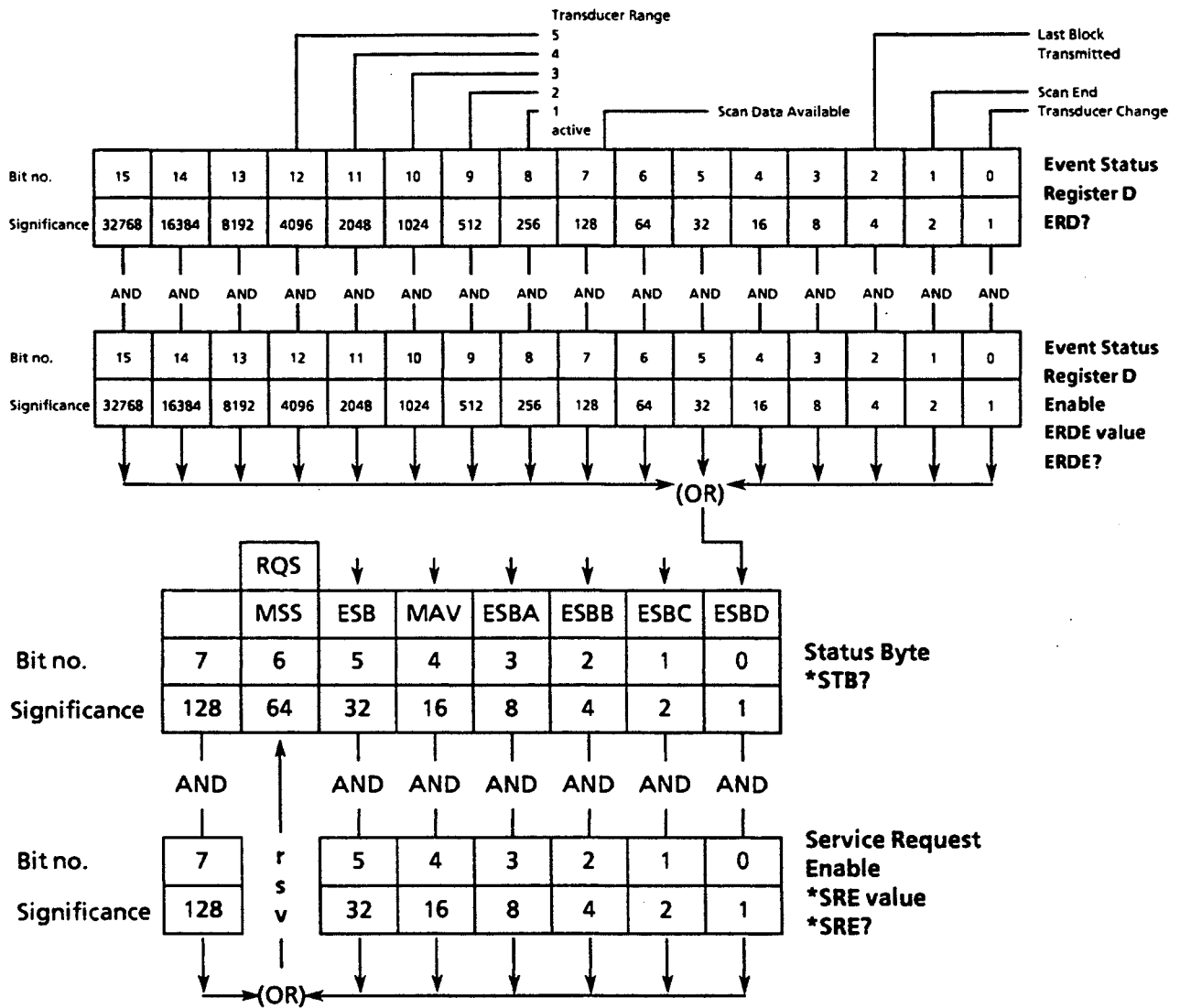

The bit "Last Block Transmitted" is set after output of the last block of measured values of a scan.

Additional Program Examples

Example 8: Use of the Enhanced Tree Walking Algorithm

This example shows which characteristics the algorithm specified in the IEEE 488.2 standard has and how it can be applied usefully.

The IEEE 488.2 standard permits the combination of several commands separated by ';' in a character string. The "Enhanced Tree Walking Algorithm" provides that two commands separated by ';' can be composed to form one command (exception: Common Commands).

Starting from the right, command recognition replaces the header parts of the first command by the first header part of the second command until either a combination has been recognized to be permissible or the beginning of the first command has been reached.

Example:

The program line

```
100 IEC OUT Fsa, "FREQUENCY:START 1MHZ;STOP 2MHZ"
```

is processed by the command recognition in the instrument like the following two program lines:

```
100 IEC OUT Fsa, "FREQUENCY:START 1MHZ"  
110 IEC OUT Fsa, "FREQUENCY:STOP 2MHZ"
```

According to the standard, this backward "walking through" the header parts does not occur when the command begins with a ':' after the ';'. The command recognition then starts again at the beginning of the command tree after the ';'.

Example:

The program line

```
100 IEC OUT Fsa, "LEVEL:REFERENCE -10DB;:REFERENCE:LINE -10DB"
```

is processed by the command recognition in the instrument like the following two program lines:

```
100 IEC OUT Fsa, "LEVEL:REFERENCE -10DB"  
110 IEC OUT Fsa, "REFERENCE:LINE -10DB"
```

If, however, the ':' before the command "REFERENCE:LINE" is omitted, this command is composed to form the following program line due to the Enhanced Tree Walking Algorithm:

```
110 IEC OUT Fsa, "LEVEL:REFERENCE:LINE -10DB"
```

As the commands stored in the instrument do not include this command, it causes an error message.

Thus it is recommended to start commands after a ';' with a ':' unless the Enhanced Tree Walking Algorithm is to be used intentionally.

Example 9: Readout of Scan Data in the ASCII Format

This example shows the operations required to read out the scan data in the ASCII format.

The SRQ processing is configured in such a way that a service request is generated when a new block of measured values is available as well as when the last block of measured values has been transmitted.

The data are read in a separate subroutine and can be processed there if required.

```
10 REM ===== Collect Scan Data
20 REM -----
30 REM      Init Section
40 REM -----
50   Fsa=20
60   Samples_complete%=0
70                                     REM Setup Controller
80   IEC TERM 10: IEC TIME 5000
90                                     REM Setup Device
100  IEC OUT Fsa,"*CLS;*RST"
110  IEC OUT Fsa,"MODE EMI_SCAN"
120  IEC OUT Fsa,"SCAN:RESULTS:CLEAR"
130                                     REM Enable SRQ on Scan Data Available
140                                     REM and Last Block Transmitted
150  IEC OUT Fsa,"ERDE 132;*SRE 1"
160 REM
170 REM -----
180 REM      Define Settings
190 REM -----
200                                     REM Define frequency range
210  IEC OUT Fsa,"SPAN LOGARITHMIC"
220  IEC OUT Fsa,"FREQUENCY:START      150KHZ"
230  IEC OUT Fsa,"FREQUENCY:STOP      30MHZ"
240                                     REM Define receiver settings
250  IEC OUT Fsa,"SCAN:SINGLE"
260  IEC OUT Fsa,"SCAN:STEPSIZE        5KHZ"
270  IEC OUT Fsa,"MEASUREMENT:TIME    20MS"
280  IEC OUT Fsa,"BANDWIDTH:RESOLUTION 9KHZ"
290                                     REM Define data format
300  IEC OUT Fsa,"SCAN:BLOCK:COUNT  1"
310  IEC OUT Fsa,"SCAN:BLOCK:FORMAT  ASCII"
320 REM
330 REM -----
340 REM      Start Scan
350 REM -----
360  ON SRQ1 GOSUB Srq_routine
370  IEC OUT Fsa,"SCAN:RUN"
380  REPEAT
390                                     REM Do something useful or just wait
400  UNTIL Samples_complete%
410  END
420 REM =====
430 REM
440 REM -----
450 REM      SRQ-Routine
460 REM -----
```



```

470Srq_routine:
480   IEC OUT Fsa,"ERD?": IEC IN 20,Erd$
490                                     REM Test if data available
500   IF (VAL(Erd$) AND 128) THEN GOSUB New_data
510                                     REM Test if Last Block Transmitted
520   IF (VAL(Erd$) AND 4) THEN Samples_complete%=1
530   ON SRQ1 GOSUB Srq_routine: RETURN
540 REM
550 REM -----
560 REM       Read Scan Data
570 REM -----
580New_data:
590   IEC OUT Fsa,"SCAN:BLOCK?": IEC IN Fsa,Scan$
600                                     REM Here is where the data can be
610                                     REM stored, analyzed or printed
620   RETURN
630 REM =====

```

Example 10: Readout of Scan Data in Binary Format Using a Configuration Table

This example shows the operations required for reading out the scan data in binary format.

Further, two scan ranges are defined via the configuration table in which measurement is effected at different band and step widths.

Please observe that the terminator of the controller is initialized to 'EOI' for the binary transmission.

```
10 REM ===== Collect Scan Data (Multiple Scan Ranges)
20 REM -----
30 REM          Init Section
40 REM -----
50   Fsa=20
60   Samples_complete%=0
70                                     REM Setup Controller
80   IEC TERM 1: IEC TIME 5000
90                                     REM Setup Device
100  IEC OUT Fsa,"*CLS;*RST"
110  IEC OUT Fsa,"MODE EMI_SCAN"
120  IEC OUT Fsa,"SCAN:RESULTS:CLEAR"
130                                     REM Enable SRQ on Scan Data Available
140                                     REM and Last Block Transmitted
150  IEC OUT Fsa,"ERDE 132;*SRE 1"
160 REM
170 REM -----
180 REM          Define Settings
190 REM -----
200                                     REM Define data format
210  IEC OUT Fsa,"SCAN:BLOCK:COUNT 10"
220  IEC OUT Fsa,"SCAN:BLOCK:FORMAT BINARY"
230                                     REM Define frequencies
240  IEC OUT Fsa,"FREQUENCY:START 9KHZ"
250  IEC OUT Fsa,"FREQUENCY:STOP 30MHZ"
260  IEC OUT Fsa,"SPAN LOGARITHMIC"
270  IEC OUT Fsa,"SCAN:SINGLE"
280                                     REM Define configuration table
290  Cmd$="CONFIGURATION:TABLE1 2,"
300                                     REM Define first scan range
310  Cmd$=Cmd$+"9KHZ,150KHZ,200HZ,100MS,OFF,ON,LIN,100HZ,"
320                                     REM Define second scan range
330  Cmd$=Cmd$+"150KHZ,30MHZ,9KHZ,20MS,OFF,ON,LIN,5KHZ"
340                                     REM Send configuration table to device
350  IEC OUT Fsa,Cmd$
360                                     REM Enable configuration
370  IEC OUT Fsa,"CONFIGURATION:TABLE1 ON"
380 REM
390 REM -----
400 REM          Start Scan
410 REM -----
420  ON SRQ1 GOSUB Srq_routine
430  IEC OUT Fsa,"SCAN:RUN"
440  REPEAT
450                                     REM Do something useful or just wait
460  UNTIL Samples_complete%
```



```

470 END
480 REM =====
490 REM
500 REM -----
510 REM SRQ-Routine
520 REM -----
530Srq_routine:
540 IEC OUT Fsa,"ERD?": IEC IN 20,Erd$
550 REM Test if data available
560 IF (VAL(Erd$) AND 128) THEN GOSUB New_data
570 REM Test if Last Block Transmitted
580 IF (VAL(Erd$) AND 4) THEN Samples_complete%=1
590 ON SRQ1 GOSUB Srq_routine: RETURN
600 REM
610 REM -----
620 REM Read Scan Data
630 REM -----
640New_data:
650 IEC OUT Fsa,"SCAN:BLOCK?": IEC IN Fsa,Scan$
660 REM Here is where the data can be
670 REM stored, analyzed or printed
680 RETURN
690 REM =====

```

Supplements J to S to Operating Manual FSA, FSB, FSM, ESAI, ESBI (for Firmware Versions 2.50 and later)

New Functions (for all Models)

DISPLAY:

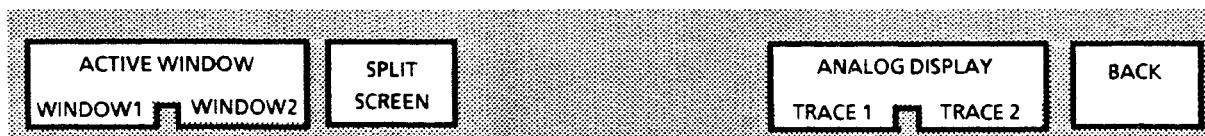

The Analog Display function allows the quasi-analog display of the measurement curve. Usually (Analog Display Off), the measured values are linked by lines resulting in a closed curve. The next sweep causes the previous curve to be deleted and the new curve to be displayed.

After having activated the Analog Display function, each measured value is represented by a pixel on the screen. The pixels are not deleted by the following sweep. The curves resulting from subsequent sweeps are thus superposed on each other, allowing, for example, the quasi-analog display and intermodulation measurements in TV channels.

The measured values are deleted by means of Trace Clr/Write or, with the following trace modes activated, by pressing Trace Max.Hold or Trace Average again.

Note:

The quasi-analog display can be copied to printers only. Plotters output only the sweep most recently traced.

Also, marker functions are possible only for the sweep most recently executed.



Switching the quasi-analog display for Trace 1 ON and OFF.



Switching the quasi-analog display for Trace 2 ON and OFF.

SPECIAL FUNCTIONS, right-hand supplementary menu:

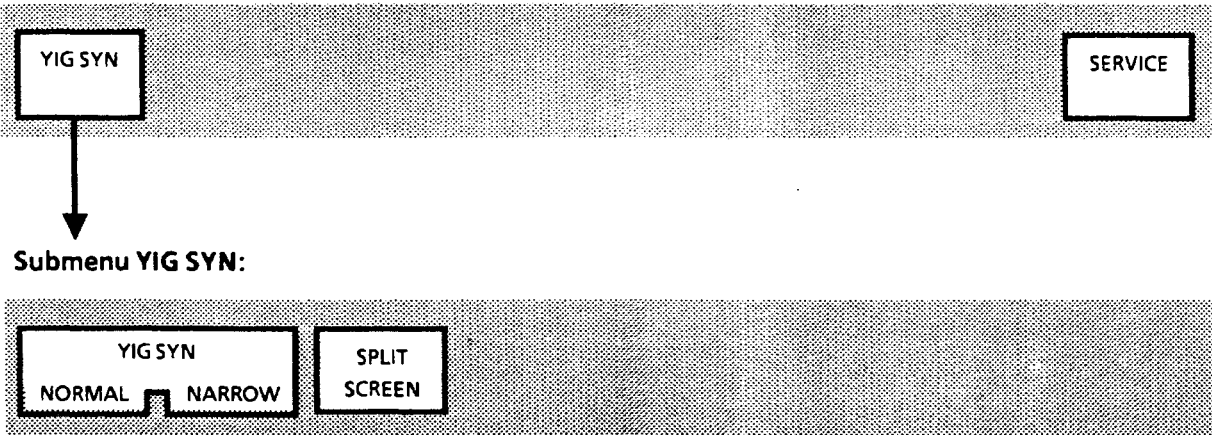

Right-hand suppl. menu SPECIAL FUNCTIONS



Branches to a submenu allowing modifications in the characteristics of the 1st LO as far as phase noise with zero span is concerned.



Reduces phase noise with a small frequency offset in the zero span (corresponds to Preset).

Submenu YIG SYN

Different selections as a function of span are made in order to enhance the characteristics of the 1st LO. With zero span or small spans and, at the same time, a low frequency offset, a reduction in phase noise can be obtained. Yet, with a high frequency offset, phase noise is slightly increased. This selection can be changed for applications involving zero span and high frequency offsets.

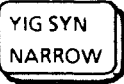

Reduces phase noise with a large frequency offset in the zero span.

Submenu COUPLED FUNCTIONS, Coupling Manual:

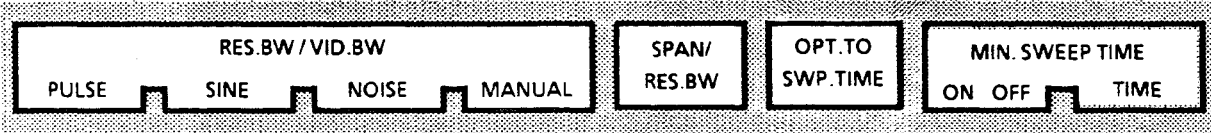

Switches sweep time limitation ON and OFF. With minimum sweep time ON and coupled sweep time, the sweep time is limited to the value entered. With Preset, Min. Sweep Time is OFF.



Enter the minimum sweep time, which is permitted as the lowest value in the case of coupled sweep time.

Note: *Allows the sweep time to be matched to the pulse repetition rate of a pulsed input signal.*

New IEC Bus Commands (for all Models)

Command	Data	Meaning
*OPC	---	<p>Operation Complete command: sets Bit 0 in Event Status Register when preceding commands are completed; sets Bit 0 in Event Status Register at the end of sweep if the preceding command was one of the following commands:</p> <p style="padding-left: 40px;"> AUTO:RANGE CALIBRATION:SHORT CALIBRATION:TOTAL CALIBRATION:AF CALIBRATION:TRACKING CALIBRATION:FILTER MARKER:ZOOM SWEEP:START SWEEP:SINGLE SWEEP:CONTINUOUS TRANSMISSION:CALIBRATION THRU REFLECTION:CALIBRATION OPEN SHORT </p>
*OPC?	---	<p>Operation Complete Query command: puts a '0' into the output buffer when preceding commands are completed; puts a '0' into the output buffer at the end of sweep if the preceding command was one of the following commands:</p> <p style="padding-left: 40px;"> CALIBRATION:SHORT CALIBRATION:TOTAL CALIBRATION:AF CALIBRATION:TRACKING CALIBRATION:FILTER SWEEP:START SWEEP:SINGLE SWEEP:CONTINUOUS TRANSMISSION:CALIBRATION THRU REFLECTION:CALIBRATION OPEN SHORT </p>

Command	Data	Units	Meaning
DISPLAY:ANALOG:T1 DISPLAY:ANALOG:T2	ON OFF ON OFF	--- --- --- ---	Analog trace display in Trace 1 - on - off Analog trace display in Trace 2 - on - off
SWEEP:MIN_TIME :MIN_TIME?	20ms to 1980s INCREMENT DECREMENT ON OFF	S MS US NS	Min. sweep time (coupled mode) - Increment - Decrement - ON - OFF
YIG_SYN	NORMAL NARROW	--- ---	YIG-SYN setting: - normal - always narrow-band
ERRORS?	---	---	Output of error number 37 Normalize Transmission/ Reflection aborted 38 Response Calibration aborted 43 Response Calibration Data invalid 47 Split Screen inactive 49 Count aborted 50 Zoom aborted 51 numeric data out of range (Tracking Generator).

Function "External Mixer" (FSM only)

The left-hand supplementary menu of the Frequency key allows the extension of the analyzer frequency range with the help of an external mixer in Analyzer mode.

The following relation applies to the conversion of harmonics:

$$f_i = n * f_{LO} - f_{IF}$$

- f_i input frequency
- f_{LO} frequency of 1st LO
- f_{IF} IF frequency 221.4 MHz
- n number of harmonic

FREQUENCY, left-hand supplementary menu:

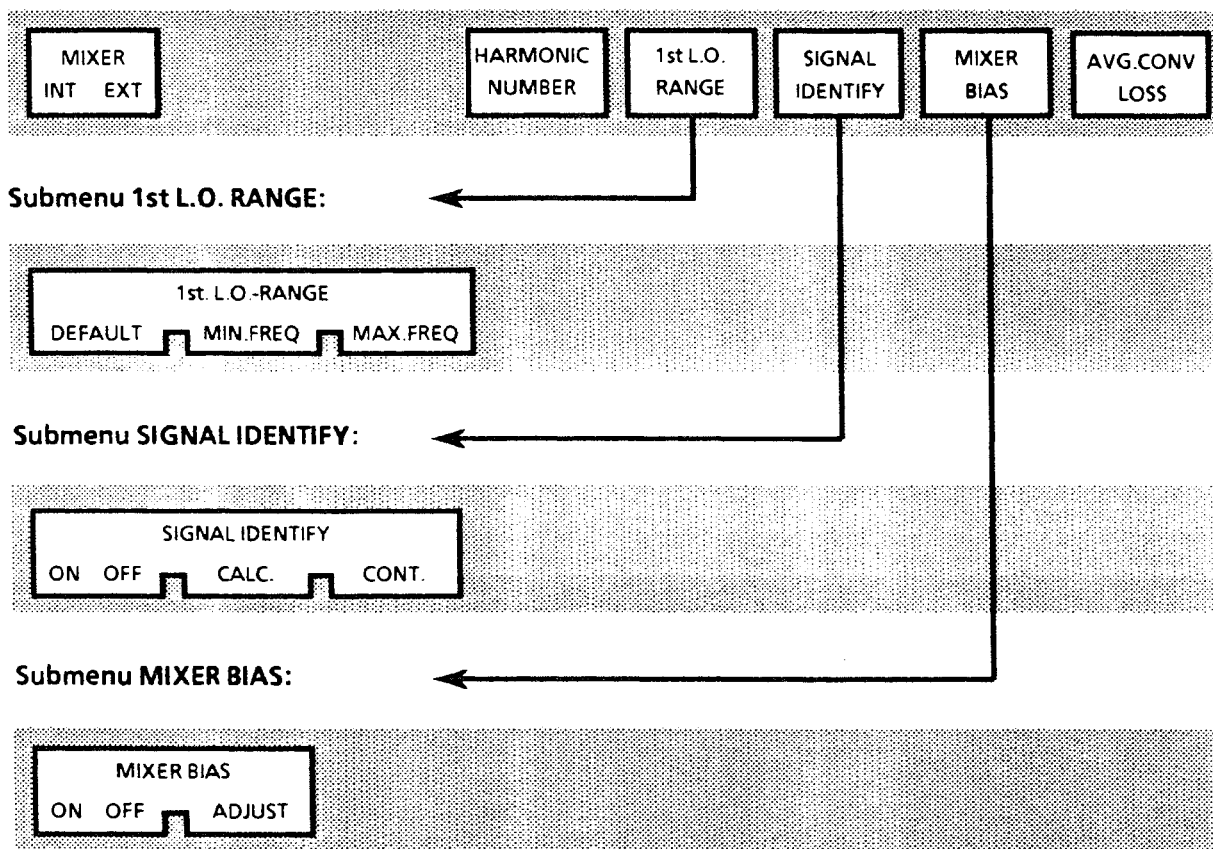

Left-hand supp. menu FREQUENCY



Selection of internal or external mixer.

Upon selection of the external mixer, start and stop frequencies are matched to the permissible LO range (see submenu 1st L.O. RANGE) and set harmonics.

A number of instrument settings are required for matching the instrument to external mixer mode.

- RF preamplifier off (when it was ON before)
- RF preselection off (when it was ON before)
- Tracking generator off (when it was ON before)
- RF Attenuation coupled (always 0 dB)
- Span Log is switched to Span Lin

The reference level setting is relative to a mixer conversion loss of 0 dB. In addition, input attenuation can be set to 20 dB (Attenuation Manual).

Selecting the internal mixer switches the ID signal OFF.

External mixer mode involves some peculiarities as far as the following functions are concerned:

- Signal Count: The Signal Count function provides faulty results in the case of image signals. If required, use the ID signal to check whether it is a real signal.
- Auto Zoom: Auto Zoom and Marker Zoom also use the IF counter, which is why the above restrictions apply.



The harmonics input together with the permissible LO range determine the analyzer frequency range settable in each case. The following relations apply to the settable ranges:

$$f_{\text{MIN}} = n * f_{\text{LO(MIN)}} - f_{\text{IF}}$$

$$f_{\text{MAX}} = n * f_{\text{LO(MAX)}} - f_{\text{IF}}$$

With the preset values for the LO range, the following table results:

Band	Range (GHz)	Harmonics No.
K	18 - 26.5	3
A	26.5 - 40	4
Q	33 - 50	4
U	40 - 60	5
V	50 - 75	7
E	60 - 90	7
W	75 - 110	9
F	90 - 140	11
D	110 - 170	14
G	140 - 220	17
Y	170 - 260	20
J	220 - 330	26



Submenu for entering the LO range, allowing the flexible matching to the permissible LO frequency ranges of mixers from a wide variety of manufacturers. The maximum permissible range extends from 5.27 GHz to 13.14 GHz.

SIGNAL IDENTIFY

Branches to the submenu SIGNAL IDENTIFY. The functions included in this submenu allow the differentiation between signals and undesired signals, which are caused by image and multiple reception due to the other harmonics of the LO.

MIXER BIAS

Branches to the submenu for setting the mixer operating point.

AVG.CONV LOSS

Sets the average conversion loss of the external mixer. Both the entry and display of the reference level are corrected by this amount. The message LVLOFF (level offset) marks this correction value in the display.

Note: *Entering the reference level offset has the same function. The frequency-dependent portion of the conversion loss can be corrected using the transducer tables.*

Submenu 1st L.O. RANGE

LO-RANGE DEFAULT

Sets the range limits of the 1st LO to the maximum permissible LO range of 5.27 to 13.14 GHz.

LO.RANGE MIN.FREQ

Entering the minimum permissible LO frequency. The difference between minimum and maximum LO frequency must be at least 1 GHz. Changing the minimum LO frequency causes the analyzer start and stop frequencies to be adjusted to the new LO setting range, if required.

Note: *For the Signal ID procedure, the 1st LO is additionally tuned down by 442.8 MHz per harmonic number. Use of Signal ID requires setting the minimum LO frequency such that there is an appropriate margin to the limit.*

LO.RANGE MAX.FREQ

Enter the maximum permissible LO frequency. The difference between minimum and maximum LO frequency must be at least 1 GHz. Changing the maximum LO frequency causes the analyzer start and stop frequencies to be adjusted to the new LO setting range, if required.

Submenu SIGNAL IDENTIFY

When using an external mixer, a number of undesired signals due to image and multiple reception are produced in addition to the desired receive signal. The SIGNAL IDENTIFY submenu provides the functions necessary for differentiation between desired and undesired signals.

Frequency Shift procedure:

Frequency shift requires a sweep between start and stop frequency (measurement curve). A second sweep is performed with a 1st LO shifted by the frequency of $2 * IF / \text{harmonic number}$ (reference curve). Real signals only are displayed at the same position on the screen. These two sweeps are displayed alternatively in Trace 1 and Trace 2. Using mathematical evaluation methods, a trace in which the undesired conversion products are filtered out can be calculated.



Switching the Signal ID on and off.

Switching Signal ID on activates Trace 1 and Trace 2 for the measurement curve and reference curve, respectively. Trace 3 and Trace 4 are set to Blank.

Switching Signal ID off resets Trace 2 to Blank.

With Signal ID ON, Trace 1 and Trace 2 are fixedly coupled, ie switchover of Trace 1 simultaneously switches Trace 2 over and vice versa. Changing Trace 3 or Trace 4 automatically deactivates the Signal ID function.

Note: *The setting Split Screen (Display menu) is highly suited for display and optical comparisons.*



With external mixer and Signal ID activated, Trace 1 and Trace 2 are converted into a measurement curve free from undesired conversion products by way of calculations. This curve is displayed in Trace 1.

Activation of the Split Screen function causes the measurement curve to be stored in Trace 2; without Split Screen, Trace 2 is deleted. Trace 3 and Trace 4 contain the measurement curve and reference curve, respectively. After conversion of the curve, Trace 1 and Trace 2 are frozen in order to avoid overwriting of the calculated trace.



Reactivates Traces 1 and 2 after having triggered the Signal ID CALC. function and starts the sweep.



Switches the voltage source of the Mixer Bias setting from 0 V (off) to the desired output voltage and vice versa (presetting off). For the use of R&S mixers FS-Z16, FS-Z18, FS-Z19, FS-Z20 and FS-Z21, select the setting "off". These mixers operate without bias.



Allows the adjustment of the mixer bias in order to set the minimum conversion loss. The analyzer provides a voltage source for this purpose. The signal can be derived from the PROBE/CODE coding female connector, pin L.

Dynamic range: -2 V ... +2 V
Resolution: 1 mV
Current carrying capacity: max. 10 mA

IEC-Bus Commands "External Mixer" (only FSM)

Command	Data	Units	Meaning
AVG_CONV_LOSS AVG_CONV_LOSS?	-116 to + 120 dB INCREMENT DECREMENT	DB --- ---	Reference level offset Increment Decrement
HARMONIC:NUMBER	3 to 200 INCREMENT DECREMENT	--- --- ---	Select the desired harmonic Increment Decrement
LO RANGE:DEFAULT :MIN FREQ :MIN FREQ? :MAX FREQ :MAX FREQ?	--- 5.27 to 12.14 GHz INCREMENT DECREMENT 6.27 to 13.14 GHz INCREMENT DECREMENT	--- HZ KHZ MHZ GHZ --- --- HZ KHZ MHZ GHZ --- ---	Frequency range of 1st LO: Default setting Lower frequency limit Increment Decrement Upper frequency limit Increment Decrement
MIXER :BIAS :BIAS?	INTERNAL EXTERNAL -2.047 V to + 2.047 V ON OFF	--- --- V MV UV NV --- ---	External mixer on External mixer off Set the mixer operating point Operating point setting active inactive
SIGNAL_ID :CALCULATE :CONTINUE	ON OFF	--- ---	Signal identification on Signal identification off Filter out conversion pro- ducts Continue signal identifica- tion

Supplements A to B to the Operating Manual of the Spectrum Analyzer Family ESxl and FSxx

New menu items and functions

Menu display:



The LIST SCREEN function displays the values of the frequency and display lines as well as the differences between them. The function cannot be combined with SPLIT SCREEN.

Extension of the SPECIAL FUNCTIONS menu

Lefthand supplementary menu SPECIAL FUNCTIONS

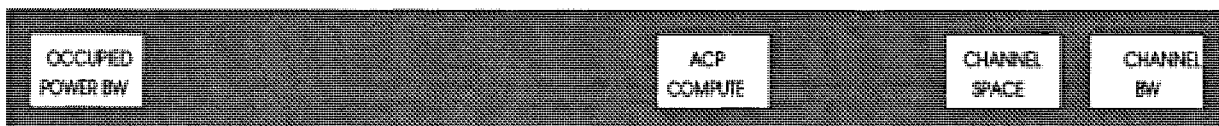

Measurement of occupied bandwidth



An important characteristic of a modulated signal is the bandwidth it occupies. In a radio transmission system, for example, it must be limited so that interference-free transmission is possible in adjacent channels. The occupied bandwidth is defined as the bandwidth which contains a particular percentage of the total power of a transmitter. The power percentage is defined to be 99 %.

First the total power between start and stop frequency is determined. Then, starting at the start/stop frequency, the points containing 0.5 % of the total power each are determined. The difference between the frequencies results in the bandwidth. To ensure a proper measurement, only the signal to be measured may be visible on the screen. A further signal would invalidate the measurement.

Adjacent channel power measurement

In the adjacent channel power measurement, the power ratio between the lower and upper adjacent channel and the main channel is measured and displayed. The center frequency of the channel must be set as the CENTER FREQUENCY. The span is set automatically depending on the channel spacing and the channel bandwidth and reads: $2 * \text{channel spacing} + \text{channel bandwidth}$. All other parameters must be set manually. The display of the measurement results can be deactivated in the DISPLAY menu (LIST SCREEN).

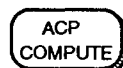

Measurement of adjacent channel power. The ratios are displayed in the fields ACP L for the lower and ACP H for the higher adjacent channel.



Input of channel spacing. The span and the channel bandwidth are matched automatically.



Input of channel bandwidth. The span and the channel spacing are matched automatically.

Modifications of the Scalar Network Analyzer

Normalization with tracking generator

In the case of version 2.75 and above, the normalization is no longer switched off automatically when the LEVEL RANGE is changed. Changing the level range with activated normalization causes a higher graphical resolution with the same dynamic range.

Note: The LEVEL RANGE used for performing the calibration of the transmission and reflection measurement determines the useful dynamic range.

If, with normalization activated, the range is enlarged compared with the calibration setting, it is advisable to perform another calibration.

Supplements to Option FSA-B3

The manual has been modified as follows:



Calibrating the Level Accuracy of the RF Filters

If a tracking generator is not fitted when the *CALIBRATE FILTER* function is called, the calibration can't be performed. In this case, the *CALIBRATE FILTER* softkey has no function.

2 Operation

(see Figs. 2-1 and 2-2 in Appendix)

The bold-faced, italic numbers refer to the item numbers in Figs. 2-1 and 2-2. The values in this section are not guaranteed; only the specifications of the data sheet are binding.

2.1 Explanation of Operating Controls

2.1.1 Front Panel of Display Unit

1
Page 2.25

Color monitor for displaying results.

Caution!

(For physical reasons, the instrument is sensitive to magnetic fields and also generates electric and magnetic fields itself).

5
Page 2.32
SPECIAL FUNCTIONS



Selection of menu for special functions.



One or more special functions switched on.



No special function active.

2
Page 2.27

SCREEN



Selection of menu for setting up of monitor 1.

6
Page 2.37

DISPLAY LINE



Selection of menu for superimposing (measurement) lines on screen.

3
Page 2.20

MODE



Selection of menu for operating mode.

7
Page 2.41

PLOT



Selection of menu for documentation.

4
Page 2.30

DISPLAY



Selection of menu for formatting of display.

8
Page 2.43

HELP



Selection of menu for operator support.

9

Page 2.47

SWEEP

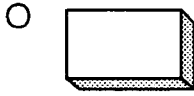

Selection of menu for operator support.



Sweep active.



Sweep not active.
Reset phase.

10

Page 2.49

TRIGGER



Selection of menu for setting sweep trigger.

11

Page 2.50

TRACE

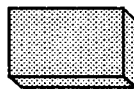

Selection of menu for defining mode of video memory.

12

Page 2.52

MULTI MARKER



Selection of menu for max. 8 level markers.

13

Page 2.53

MARKER

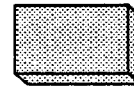

Selection of menu for reference and delta marker.

14

Page 2.57

AUTO

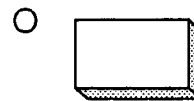

Selection of menu for various automatic functions.



Automatic system of corresponding function on.



Automatic system of corresponding function not in operation.

15

Page 2.59

COUPLED FUNCTIONS

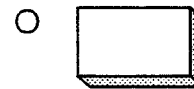

Selection of menu for automatic coupling of span, resolution bandwidth, video bandwidth and sweep time.



Selected parameter is coupled to the other parameters.



Parameter is not incorporated in coupling.
(manual control).

16

Page 2.71

PHONES



Headphones connection. This is active only if the frequency span is zero (receiver mode).

22

Page 2.15



8 selection keys for menu control. Function depends on selected menu.

23

Page 2.17

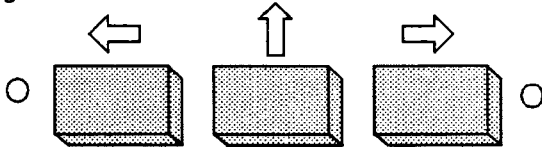

Center key: enables return to next higher menu level.
Left and right keys: extension of selection range of menu when more than 8 menu functions are available.



Further menu functions can be selected in the corresponding direction.



Menu level is empty in the corresponding direction.

24

Page 2.151

KEYBOARD



Socket for external keyboard. Connected in parallel to socket 60 on rear panel.

2.1.2 Front Panel of RF Unit

25

Page 2.70

LOCAL



Switches back from IEC-bus control to manual operation.



REMOTE

Instrument is controlled by an external controller.



SRQ

Instrument is sending a Service Request.

26

Page 2.62

FREQUENCY

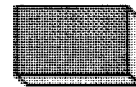

Selection of frequency menu.

27

Page 2.64

SPAN

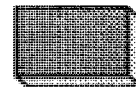

Selection of span menu.

28

Page 2.18

BACK SPACE

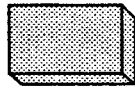

Used to correct faulty entries.

Incorrect number keyed in before pressing associated ENTER key **31**:
last number keyed in is cleared.

Incorrect entry of complete sequence terminated by ENTER **31**:
the complete sequence is cleared and the previous value is set again (undo function).

32

Page 2.19

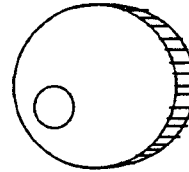

Spinwheel for modifying numeric values. The parameter to be modified must first be selected.

Magnetic latching indicates the step size when rotating; the number of steps per rotation is 24.

29

Page 2.70

SAVE

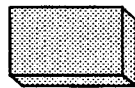

Selection of save function for settings.

33

Page 2.19



Rapid variation of data to larger values.

30

Page 2.70

RECALL

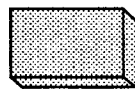

Selection of stored settings.

34

Page 2.19



Rapid variation of data to smaller values.

31

Page 2.17

				GHz	s
				V	-dBm
				MHz	ms
				mV	+dBm
				kHz	µs
				µV	dB
				Hz	ns
				nV	dB..

Numeric keypad to enter numbers (consisting of 12 numeric keys and 4 ENTER keys).

35

Page 2.65

HOLD



Blocking of data variation by **32, 33, 34**.



ENABLED

Data variation enabled.

36

Page 2.70

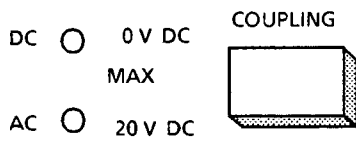

Selection of DC isolation for input 37. Caution when operating without DC isolation: DC voltage can destroy input divider and/or input mixer.

Observe automatic function AC/DC 14.

DC DC coupling is switched on.

AC AC coupling is switched on. Not more than 20 V DC may be applied.

37

Page 2.21

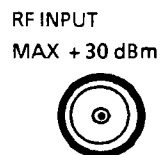

N socket, impedance 50 Ω.

Maximum power:

Normal mode (≥ 10 dB attenuation):

< +30 dBm.

With 0-dB RF attenuation: < +20 dBm.

Caution with broadband signals: connect ahead pulse-insensitive attenuator or pulse limiter.

38

Page 2.23

CAL OUTPUT
-20 dBm/100 MHz



BNC socket, 50 Ω.

Level -20 dBm \pm 0.2 dB.

Used to check the level calibration or the input divider.

39

Page 2.153

PROBE/CODE



12-way TUCHEL socket. Used for DC supply and taking into account the characteristics of level and/or frequency converters connected ahead.

40

Page 2.66

UNITS

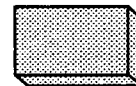

Selection of menu for selection of level unit.

41

Page 2.68

LEVEL RANGE

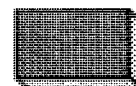

Selection of menu for the displayed level range.

42

Page 2.69

REF LEVEL

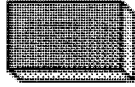

Selection of menu for the reference level.

43

Page 2.26

PRESET

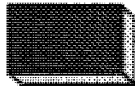

Instrument is reset to a defined status (see Section 2.3.6.3 PRESET).

44

Page 2.14

STANDBY

- DISPLAY
- RF



The corresponding unit is supplied with AC power. Condition: ON/OFF key 46 is switched off.

- The corresponding unit is switched on by means of the ON/OFF key 46 or the AC supply is missing.

CHECK

- DISPLAY
- RF



On activation of the ON/OFF key 46, an internal self-test sequence is performed for approx. 10 sec.

An error has been detected if one or both of the LEDs light(s) up at the end of the test sequence.

45

Page 2.43

- SELFTEST
- CAL



A self-test or a calibration procedure has been triggered.

- The corresponding process has not been selected or has been successfully terminated.

46

Page 2.14

- ON

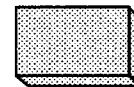

ON/OFF key for internal DC supply.

Check the AC supply before switching on for the first time.



Instrument is switched on.

- Internal DC voltages are switched off (except the + 12 V supply for the oven-controlled reference oscillator). AC power is still present in the instrument.

2.1.3 Rear Panel of Display Unit

51

Page 2.49

EXT SWEEP TRG
± 5 V / ± 20 V_{MAX}



High-impedance BNC input for an external start signal for the frequency sweep.

Nominal level: ± 5 V.
Maximum level: ± 20 V.

52

Page 2.24

IF OUT
[NARROW]
21.4 MHz



21.4-MHz IF output (narrowband).

53

VIDEO OUTPUT
0... + 1 V

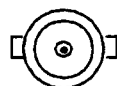

BNC output 50 Ω, for IF video signal.

Level 0 V: lower range limit
Level + 1 V: upper range limit

54

Label with instrument type, identity No., serial No.

55

Page 2.14

DC blower.

The performance of the blower depends on the ambient temperature. If the blower does not run when the instrument is switched on, an error message appears on monitor **1** and the instrument is switched off after approx. 10 min.

56

DC blower inside instrument (power pack).

57

Page 2.14

A22 ——— SUPPLY CHECK ——— A21
ERROR

Prerequisite: AC power must be present.



A21, A22:
Power pack A21, A22 operating correctly.



A21, A22:
Voltage on module A21, A22 has failed or is overloaded.



ERROR:

Error sources:

- Excess temperature
- DC blower **55** not running
- Vital module missing in display unit.

The instrument restarts automatically when cooled down following switch-off caused by an excessive temperature.

58

Page 2.14

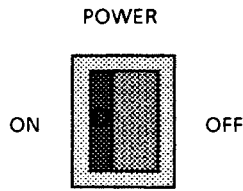

Power switch.

When switched on, AC power is present inside the instrument.

59

Page 2.13

100/120 V T4.0	47...
220/240 V T2.5	440 Hz

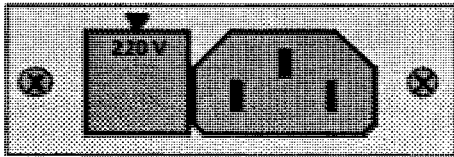

AC power selector and connection. Check the AC supply and the fuse before switching on for the first time.

60

Page 2.151

KEYBOARD



Socket for external keyboard. Connected in parallel with socket 24 on front panel.

61

Page 2.145

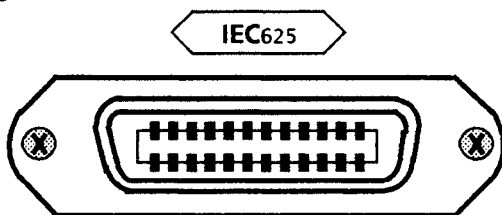

IEC-bus connector.

62

Page 2.149

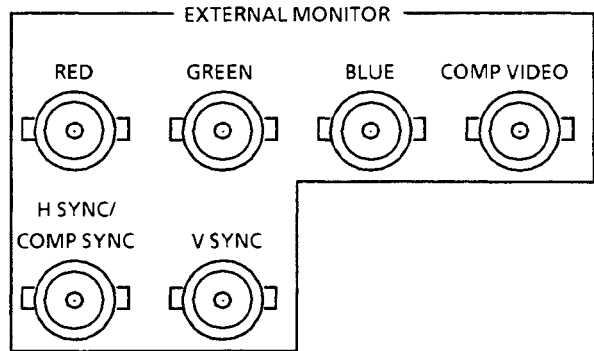

BNC sockets for an external black-and-white monitor, a color monitor or a hardcopy device. The control signals can be modified in accordance with the external device.

63

Page 2.12

ANALYZER BUS X132

Connector for cable to RF unit, item 69.

64

Page 2.12

ANALYZER BUS X133

Connector for cable to RF unit, item 82.

65

Page 2.152

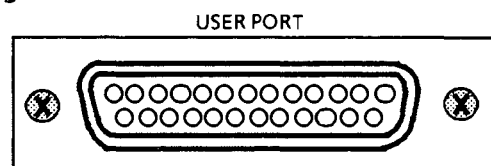

Connector for control of external components (TTL level).

2.1.4 Rear Panel of RF Unit

66

Page 2.146

PARALLEL INTERFACE

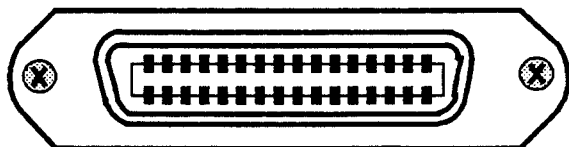

Similar to Centronics interface. Used to control external printers.

67

Page 2.147

RS 232

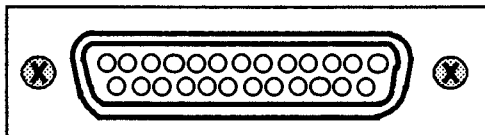

RS-232 interface.

68

Page 2.148

EXT FLOPPY

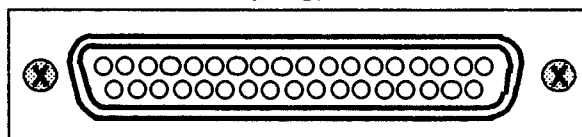

Connection for up to three floppy disk drives.

69

Page 2.12

ANALYZER BUS X132

Connector for cable to display unit, item **63**.

70

Label with instrument type, identity No., serial No.

71

Page 2.14

DC blower.

The performance of the blower depends on the ambient temperature. If the blower does not run when the instrument is switched on, an error message appears on monitor **1** and the instrument is switched off after approx. 10 min.

72

DC blower inside instrument (power pack).

73

Page 2.14

POWER

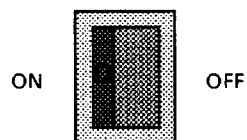

Power switch.

When switched on, AC power is present inside the instrument.

74

Page 2.13

100/120 V T4.0 47...
220/240 V T2.5 440 Hz

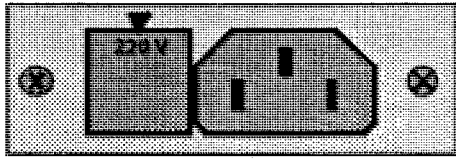

AC power selector and connection. Check the AC supply and the fuse before switching on for the first time.

75

Page 2.14

- A22 ——— SUPPLY CHECK ——— A21
- OVEN ERROR

Prerequisite: AC power must be present.

A21, A22:
Power pack A21, A22 operating correctly.

A21, A22:
Voltage on module A21, A22 has failed or is overloaded.

ERROR:
Error sources:
- Excess temperature
- DC blower 71 not running

The instrument restarts automatically when cooled down following switch-off caused by an excessive temperature.

OVEN:
Internal reference oscillator is being heated.

76

Page 2.80

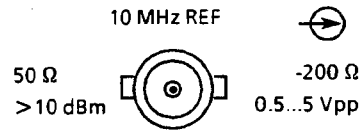

BNC socket, 50 Ω.
Optional output for internal reference signal or input for external reference signal.

78

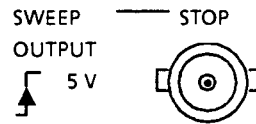

BNC socket, TTL level.
Change in logic level indicates stop of sweep.

79

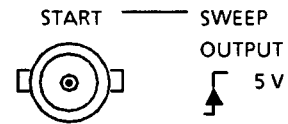

BNC socket, TTL level.
Change in logic level indicates start of sweep.

80

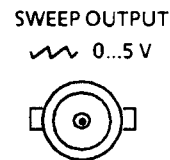

BNC socket.
The voltage proportional to the span is:
0 V at start frequency
+ 5 V at stop frequency

81

Page 2.23

IF OUTPUT
21,4 MHz (221.4 MHz)

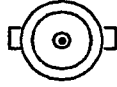

BNC socket, 50 Ω .

Broadband IF output 21.4 MHz (221.4 MHz).

82

Page 2.12

ANALYZER BUS X133

Connector for cable to display unit, item **64**.

2.2 Preparation for Use

2.2.1 Fitting the Instrument Handles

The handles are supplied loose with each unit. The two longer handles must be connected to the left and right of the display unit using the supplied screws, the two shorter handles must be connected to the RF unit.

2.2.2 Adjustment of Power Supply/Fuse Replacement

The units are set in the factory to an AC supply of 220 V. If the local supply varies by more than $\pm 10\%$ from this value, the voltage selector and the fuse on the rear of both units must be changed according to Table 2-1. The AC supply frequency must be between 47 and 440 Hz.

Table 2-1 Selection of fuses

Nominal AC supply voltage	Permissible tolerance	Permissible voltage range	Fuse	
			RF unit	Display unit
100 V	$\pm 10\%$	90 to 110 V	T4.0 020.7600	T4.0 020.7600
120 V	$\pm 10\%$	108 to 132 V	T4.0 020.7600	T4.0 020.7600
220 V	$\pm 10\%$	198 to 242 V	T2.5 020.7575	T2.5 020.7575
240 V	$\pm 1\%$	216 to 264 V	T2.5 020.7575	T2.5 020.7575

Adjustment procedure:

Caution! When working on lines upon which the AC supply could be present, always ensure that there is no connection to the supply network.

Once the two AC connectors have been removed from the AC filters of the two units, the plastic cover of the voltage selector can be lifted off using a screwdriver on the pin side of the filter units.

The cover contains a fuse corresponding to the set AC supply; this must be removed. Replacement fuses are stored in four holders inside the filter unit. Select the correct fuse according to Table 2-1 and insert into the cover. Replace the cover such that the arrow on the frame points to the required voltage.

2.2.3 Mechanical Connection of the two Units

Place the display unit onto the RF unit such that the front panel of the former protrudes approx. 3 cm beyond the front panel of the RF unit.

Push the display unit towards the rear panel so that the holder locks in place. Subsequently remove the two supplied links from the rear panel of the display unit and screw the two units together (4 milled screws).

2.2.4 Electrical Connection of the two Units

Once the mechanical connection has been made, the electrical connection can be made using the supplied set of cables:

- Connection between **63** (display unit) and **69** (RF unit) using cable W2.
- Connection between **64** (display unit) and **82** (RF unit) using cable W1.

The connectors are secured using the two screws on each plug.

The power switches **58** (display unit) and **73** (RF unit) must be switched off.

Caution! Connect the instrument exclusively to a socket with a protective earth contact.

- Connection from **59** (display unit) to AC socket.
- Connection from **74** (RF unit) to AC socket.

With housing opened, note that AC voltage may be present on the line filter connections even with the instrument power switched off.

2.2.5 Installation in 19-inch Rack

Because of the large total weight, the two units must be installed separately in the rack.

When installing in a 19-inch cabinet, ensure that the ventilation is sufficient to dissipate the power loss from the instrument.

The cooling air is to be supplied at the left (viewed from the rear), whereas a uniform heat dissipation must be ensured at the right.

It may be necessary to use a vertical sheet to separate the cooling air from the dissipated heat. Make sure that a thermal short-circuit cannot occur.

2.3 Manual Operation

2.3.1 Switching On and Subsequent Response of Instrument

With the two power switches **58** and **73** on the rear panel and the ON/OFF key **46** on the front panel switched off, insert the two AC cables into the sockets **59** and **74** and connect to the AC supply.

The two LEDs STANDBY DISPLAY and STANDBY RF **44** light up when the two power switches **58** and **73** are switched on. The LED OVEN **75** on the rear panel of the RF unit indicates that the internal reference oscillator is being heated. The two power switches remain on in normal mode; the instrument is only switched on and off using ON/OFF key **46**. When this key is pressed, the LED ON **46** lights up and the two LEDs STANDBY **44** go out; the two LEDs CHECK DISPLAY and CHECK RF **44** light up for approx. 10 s. An extensive test sequence is carried out during this time which activates display **1** and outputs the result at the end of the test.

The speed of rotation of the blowers **55** and **71** at the rear of the units is monitored and is dependent on the ambient temperature. LEDs A21, A22 (green) **57** and A21, A22 (green) **75** indicate that the power packs A21 and A22 in each unit are operating correctly. If one of these LEDs goes out, this indicates a failure or overloading of the corresponding power pack. The two LEDs ERROR (red) **57**, **75** must not light up during normal operation; if so, this means that the switch-on command is blocked.

Possible causes:

- Excess temperature in instrument (instrument switches on again automatically following cooling down with hysteresis).
- Blower **55** or **71** not running.
- Important modules missing (e.g. microprocessor, graphics, I/O modules).

The internal reference oscillator OXCO (oven-controlled oscillator) is heated further nevertheless. When the instrument is connected to the AC supply for the first time, the reference oscillator requires approx. 5 min (depending on the ambient temperature) to come close enough to its nominal frequency such that all internal synchronization loops for frequency processing can lock in. Various error messages may occur on display **1** during this time which are then automatically cancelled after the warm-up period. The instrument automatically assumes a status which exactly corresponds to the last status before switching off. Thus manual setting of the old status is superfluous and setting errors are prevented. For this reason, the status of the other LEDs on the two front panels cannot be predicted.

2.3.2 General Operation Concept

In order to combine the many facilities of the instrument with as easy as possible operation, hardkey operation where each function has its associated key has been eliminated. Alternate operation, e.g. softkey technique where a minimum number of keys contains a maximum number of alternate functions, has neither been adopted so that the user is not required to continually consider the assignment of functions to keys.

The operating concept of the analyzer is a compromise between hardkey and softkey operation:

- 48 keys with fixed functions for selecting menus (e.g. markers), such as for direct functions (e.g. LOCAL **25**) and for entering numbers (e.g. numeric keypad **31**).
- 8 keys with changing functions for selections from a menu.
- 1 spinwheel for all adjustable parameters.

This type of operation together with excellent operator prompting results in a minimum menu depth and thus very easy operation.

2.3.3 Explanation of Terms

Hardkeys:



Keys with fixed function.

Softkeys:

8 keys (SK1 to SK8) in the monitor frame whose functions (F1 to F8) are variable and depend on the respective menu.

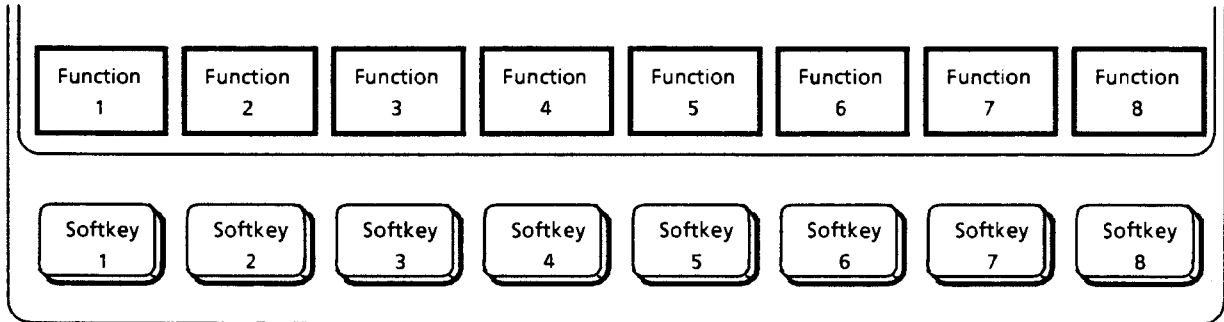

Main menu:

Functions are assigned to the softkeys by pressing a hardkey.

Submenu:

Functions are assigned to the softkeys by pressing a softkey.

Menu width:

If more than 8 functions are possible in a menu level, this menu can be extended to $n + 8$ functions (supplementary menu).

Mode:

(Higher) operating mode of instrument.

Function:

Higher operating mode of instrument, can be modified using hardkey or softkey.

Special Function:

Lower operating mode of instrument.

Display:

Output on screen.

2.3.4 Menu Operation Structure

The lower-level menu hierarchies are selected from a higher-level menu. These lower-level menu hierarchies therefore each have a characteristic format in display 1 as well as special functions suitable for this mode (and also further lower-level menus which can be selected) where the keys in the monitor frame may have different functions. All hardkeys retain their fixed functions, some are switched off in various modes and therefore have no functions.

2.3.4.1 Schematic Representation of Hierarchy

The description of the keys and their operation are explained in detail for ANALYZER mode. In the case of the other modes, their special features are merely described.

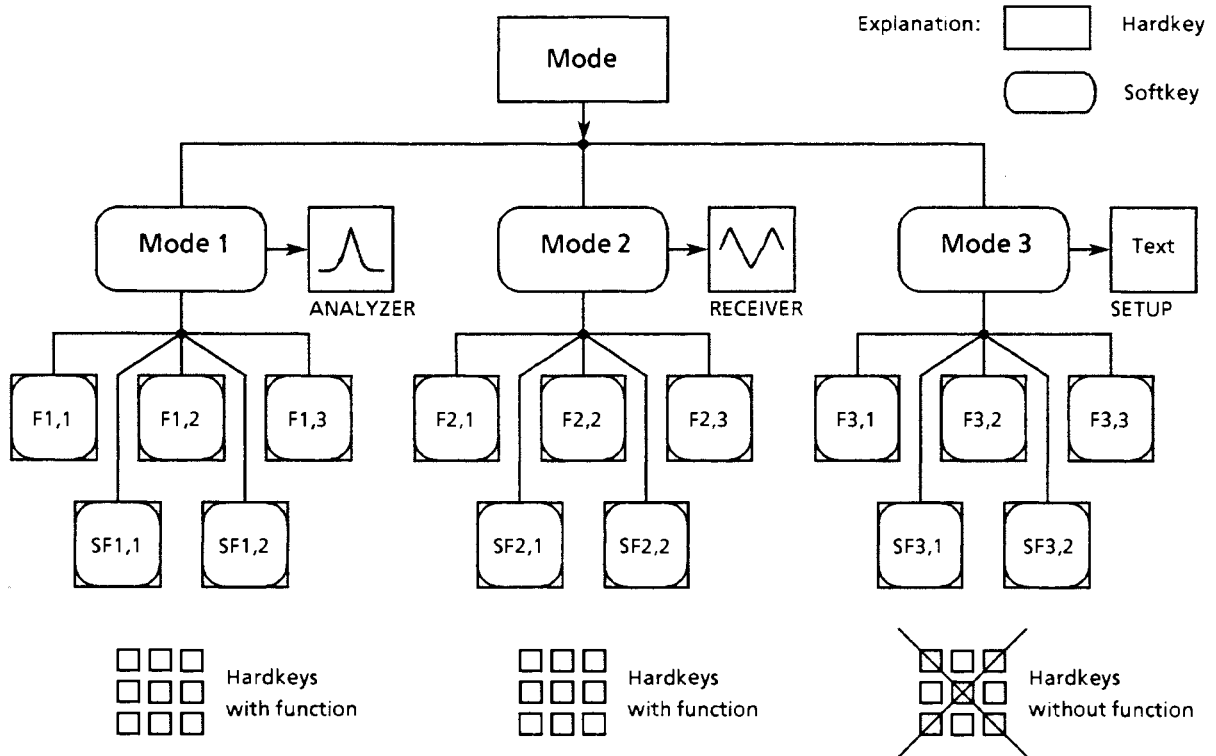

2.3.4.2 Schematic Representation of Menu Operation

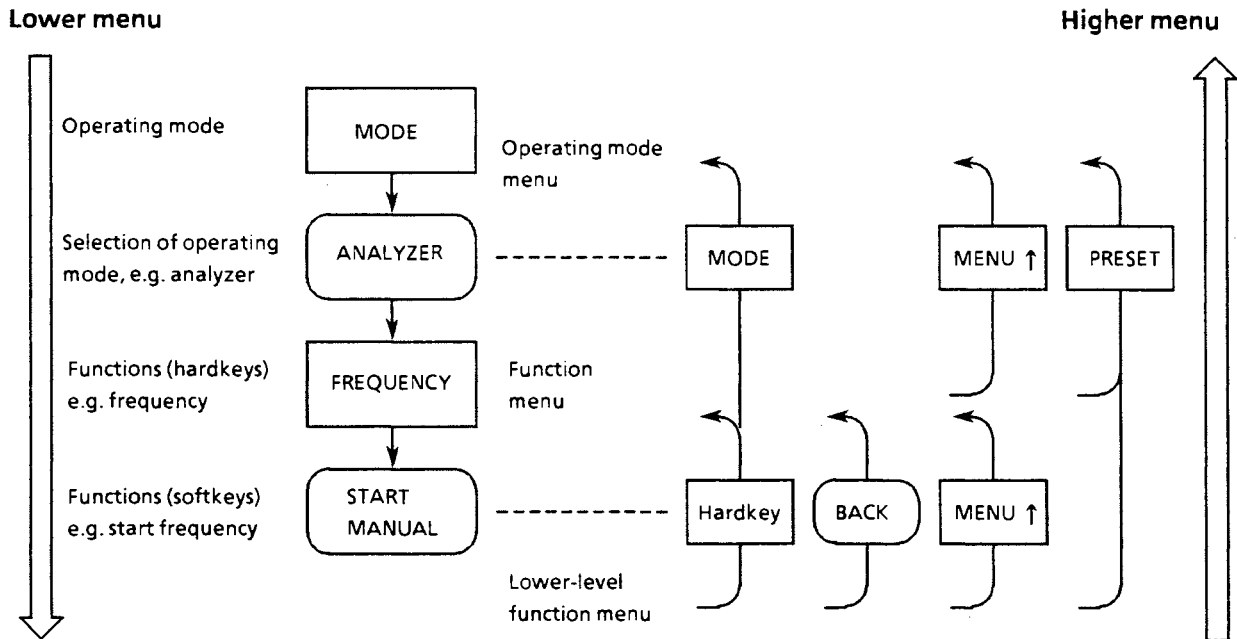

2.3.4.3 Width Control of a Menu

If up to 8 functions can be selected:

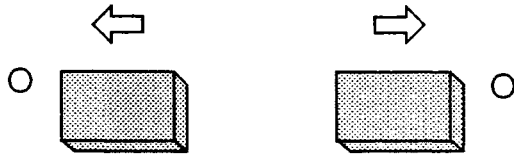

LEDs 23 do not light up.
Keys 23 (left and right) have no effect.

If more than 8 functions can be selected:



One of the two LEDs lights up.
One of the two keys provides further functions of the same menu level (supplementary menu).

2.3.4.4 Possible Status of Softkeys

The following colors refer to the basic setting of the instrument. If the colors are changed by the user, the wording of the subsequent description is correspondingly changed:

- Green: color of markers and softkeys.
- Red: color of display graticule and labelling.
- Yellow: color of trace 1.

The background color of the softkey pad is referred to as marking in the following text.

Status and their changes can be denoted by marking the softkeys.

Change in status when pressing an inactive softkey

Softkey is marked in green:

- Pressing causes immediate change in status.
- Dependent softkeys are inactivated (dependent softkeys are those whose status are mutually exclusive, e.g.: GRID ABS/REL).

Softkey is marked in red:

- Specified function is the new input function.
- Previously active input function is inactivated (e.g.: START, STOP, CENTER) or marked in green.

Change in status when pressing a softkey marked in green

Softkey remains marked in green:

- No change in status.

Softkey is not marked:

- Specified function becomes inactive (e.g. AUTO ZOOM, SIGNAL TRACK).

Softkey is marked in red:

- Specified function becomes active input function. This change in status is only possible with softkeys which are an input function and also describe an active status.
- Previously active input function is inactivated.

Change in status when pressing a softkey marked in red

Softkey remains marked in red:

- No change in status.

2.3.4.5 Data Input / Data Variation

Data entry is made using the numeric keypad 31 in all modes. The process is terminated by pressing the unit key corresponding to the input value; this key has the function of an ENTER key.

Correction of faulty entries:

- The last digit entered is cleared by pressing BACK SPACE 28 before the unit key and can be overwritten by another number.

Example:

Entry	Screen display
<div style="border: 1px solid black; padding: 2px; display: inline-block;">BACK SPACE</div>	Span 123.5
<div style="display: flex; justify-content: space-around; width: 100px;"> 4 5 6 MHz </div>	Span 123.
	Span 123.456 MHz

- If the unit key has already been pressed, BACK SPACE 28 deletes the complete last entry, i.e. the instrument is reset to the old setting.

Example:

Entry	Screen display
<div style="display: flex; justify-content: space-around; width: 100px;"> 1 GHz </div>	Center Frequency 123.456 MHz
<div style="border: 1px solid black; padding: 2px; display: inline-block;">BACK SPACE</div>	Center Frequency 1 GHz
	Center Frequency 123.456 MHz

Advantage of this method: the old status is reestablished if the entry is totally incorrect (undo function).

The intelligence of the instrument determines the resolution with which parameters may be entered for particular settings. Excess digits are automatically suppressed.

Negative numbers:

The numeric keypad **31** contains a minus sign so that it is directly possible, for example, to enter negative values for the level or frequency offset.

Example: Entry -10.7 MHz:



There is a further possibility for entering level values less than 0 dB (unit), which occurs very frequently, thus saving the pressing of one key.

Example: Entry -40 dBm:

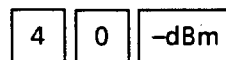

Data can also be indirectly entered using the key RECALL **30**, (N) **31** (N = 0 to 9) if corresponding data have previously been stored using SAVE **29** (N) **31**.

The current entry is output in display **1** at position **A3** (see 2.3.6.2) in the form: function/data value/unit (or ENTER).

Blocking the data entry:

The numeric entry can be blocked by pressing the key HOLD **35** (LED ENABLED goes out).

Reactivation of data entry:

Blocking is cancelled by pressing the key HOLD **35** and the softkeys UNLOCK, i.e. a numeric input using **31** is possible again.

(Blocking of all hardkeys is possible for special applications, see 2.3.6.4.)

Data variation:

Two basic methods of data variation are possible:

Step-by-step variation using **33** and **34** or quasi-continuous variation using **32**.

Step-by-step variation:

After selecting a function by means of **26, 27, 41, 42**, the corresponding parameter can be increased by the set step sizes by pressing key **33** or decreased by pressing key **34**. The step size depends on the respective parameter and the operating mode of the instrument. The selected parameter is output in display **1** at position **A3** (see 2.3.6.2). Key **33** or **34** can be pressed several times in any sequence (without further pressing of a function key), and the selected parameter is changed accordingly.

Quasi-continuous variation:

Following selection of a function by means of **26, 27, 41, 42** and a step variation (coarse) by means of **33, 34**, the corresponding parameter can be finely adjusted (= quasi-continuously) by rotating the knob **32**.

Parameters are changed to smaller values by rotating the knob in a counterclockwise direction (corresponding to **34**) or to larger values by rotating the knob in a clockwise direction (corresponding to **33**).

The step size of the variation depends on the respective parameter and the operating mode of the instrument. The selected parameter is output in display **1** at position **A3** (see 2.3.6.2). Key **32** can be rotated several times in any direction (without further pressing of a function key), and the selected parameter is changed accordingly.

2.3.4.6 Changing the Softkey Labelling Using an External Keyboard

A keyboard can be connected to the front or rear of the display unit and used for documentation purposes to write two lines of text with 84 characters each instead of the softkey labelling before the screen contents is output e.g. on a printer or plotter. This text is stored in a volatile memory and is therefore no longer available if the instrument is switched on and off again.

Refer to the hardkey function PLOT (see 2.3.6.4).

2.3.5 MODE



Following switch-on the instrument selects the last setting before it was switched off, once the self-test routine has been executed (the MODE menu is not displayed).

The self-test examines the digital hardware (all RAMs, including the screen RAM and the CMOS RAM with battery back-up) and the peripheral ICs. An extensive test of the analog hardware is also carried out. A test is also made to see whether the connections between the display unit and RF unit are made and whether the power supply is correct. Error messages are output on the screen in the event of faults except in the case of faults which prevent a screen output. In this case, the LED field TRACE 11 is used for the fault output.

The switch-on routine is executed if the hardkey PRESET 43 is pressed, and the instrument changes into analyzer mode with the default setting.

It is also possible to press the hardkey MENU 23 in which case the MODE menu with the initialization display is selected without having to execute the switch-on routine.

If the internal back-up battery for the CMOS-RAM has been replaced, the instrument is always started via the switch-on routine and the initialization display is retained, since no valid data have been stored.

Screen display:



The operating mode of the instrument is selected by pressing one of these softkeys. The possible modes are:

ANALYZER mode (see 2.3.6). The instrument operates as an RF analyzer characterized by simple operating technique and a large number of test functions.

RECEIVER mode (see 2.3.7). This mode is a special function of the ANALYZER mode and provides the instrument with additional functions for use as a test or communications receiver.

SET UP mode (see 2.3.8). Communication to and from the peripheral units (printer, plotter, user port, etc.) are largely defined in this mode.

In addition, further operating modes of the analyzer can be selected depending on the options fitted in the instrument. The description of these modes is contained in the respective manual of each model.

For the controller function "MSDOS" refer to the FS-K1 manual. With an external double floppy-disk station attached and the system disk FS-K1 inserted this softkey allows for loading the operating system MS-DOS with the R&S Basic interpreter. Without these accessories the following error message is output in the command line

"DOS-BOOT: Wrong Disk or Disk not ready"

2.3.6 ANALYZER

2.3.6.1 Theory of Operation

Basic theory:

The analyzer operates according to the principle of "sweeping signal system" analysis when used in ANALYZER mode where a particular frequency range (SPAN) is scanned by changing an internal oscillator frequency using an analyzer filter with a matched resolution bandwidth.

All spectral components of the signal which fall in the passband of this filter cause the filter to be excited and thus produce an output signal. This signal is displayed directly in the LIN RANGE mode following rectification or the logarithm is taken and the signal rectified in the LOG RANGE mode.

The frequency range to be analyzed is defined by any combination of the start frequency, centre frequency, stop frequency and span.

The parameters, resolution bandwidth, video bandwidth and sweep time important for the analysis are coupled depending on the displayed frequency range by means of a corresponding algorithm (COUPLED mode).

The analysis is represented on a colour display with the frequency in the x-direction and the associated amplitudes in the y-direction with the correspondingly selected scale.

Circuitry:

The analyzer has been dimensioned for optimum dynamic characteristics (thermal noise up to wideband overloading) with a minimum of active elements.

The block diagram (Fig. 2-3) shows the signal flow in the instrument.

The input signal passes through a selectable input attenuator (attenuation range 0 to 81 dB in 1-dB steps) via which the internal level calibration signal is also connected. After passing through the input lowpass, the input signal (100 Hz to 5000 MHz) is converted in a balanced high-level mixer to the 1st intermediate frequency of 5421.4 MHz. This mixing produces two sidebands which must be handled differently in order to keep the ripple of conversion as low as possible. The lower-frequency signal (1st ZF) is applied to a low-noise amplifier via a ring filter and a bandpass switched in series, the 2nd sideband (input frequency + 1st oscillator frequency) is applied to an ohmic terminating resistor. Selection at the 1st intermediate frequency is made using a five-stage iris-coupled cavity resonator filter with a low transmission loss. The 6-dB bandwidth of this filter is approx. 40 MHz. The IF level is increased in a further IF amplifier. In order to prevent internal inherent noise, this is followed by a cascade of lowpass filters with different cut-off frequencies which are optimally adapted to one another according to their spurious frequencies. The 1st IF signal is stepped down to the 2nd IF of 221.4 MHz in a second, balanced high-level mixing stage. The 200 MHz reference signal is used to switch to the 3rd IF of 21.4 MHz. The 3rd IF signal is amplified (according to the mode) in a selectable low-noise amplifier: the frequency response correction is also carried out here and is derived from the tuning voltage of the 1st conversion oscillator.

In order to obtain high frequency stability and low spurious FM, the complete frequency processing circuit (1st and 2nd oscillators) is designed in synthesizer technique which combines high frequency accuracy with extremely small tuning steps and low phase noise. The complex relationship between display processing and synthesizer control require a 16-bit microprocessor system.

The IF signal (21.4 MHz) applied from the RF unit to the display unit is limited in bandwidth at the frequencies 21.4 MHz or 4.194 MHz by a 5-stage selection filter, according to the set bandwidth. The filter bandwidth can be changed within a very large range (almost 6 decades) with the same relative selection response and the transient response optimized for the frequency analysis procedure. In the course of this filter bank, the signal passes through an amplifier with a selectable gain corresponding to the set reference level.

In linear mode, the IF signal passes through a 40-dB amplifier prior to rectification. In the logarithmic modes, the logarithm of the IF signal is taken in a precision amplifier and rectified.

The detector characteristic can be selected and enables a measurement optimally adapted to the signal together with the selectable video filter (cutoff frequency 1 Hz to 3 MHz). An additional parallel IF branch with automatic gain control and AM and FM demodulators enable the set signal to be monitored and thus simultaneous display on the screen.

A second 16-bit microprocessor system handles the communication with the frequency processor system as well as the level and bandwidth control.

Furthermore, this processor enables single-key operation, numeric entry, data manipulation, coupling of sweep time with span and resolution bandwidth, internal calibration, self-test, support routines for the user as well as external communication (e.g. IEC bus, various interfaces). In addition, this processor provides all information required for the screen display to the graphics system. This graphics system contains another 16-bit processor, a dual port RAM bank and a special graphics processor, and enables display of curves, grid, setting parameters and various additional features on a high-resolution (9-inch) colour monitor.

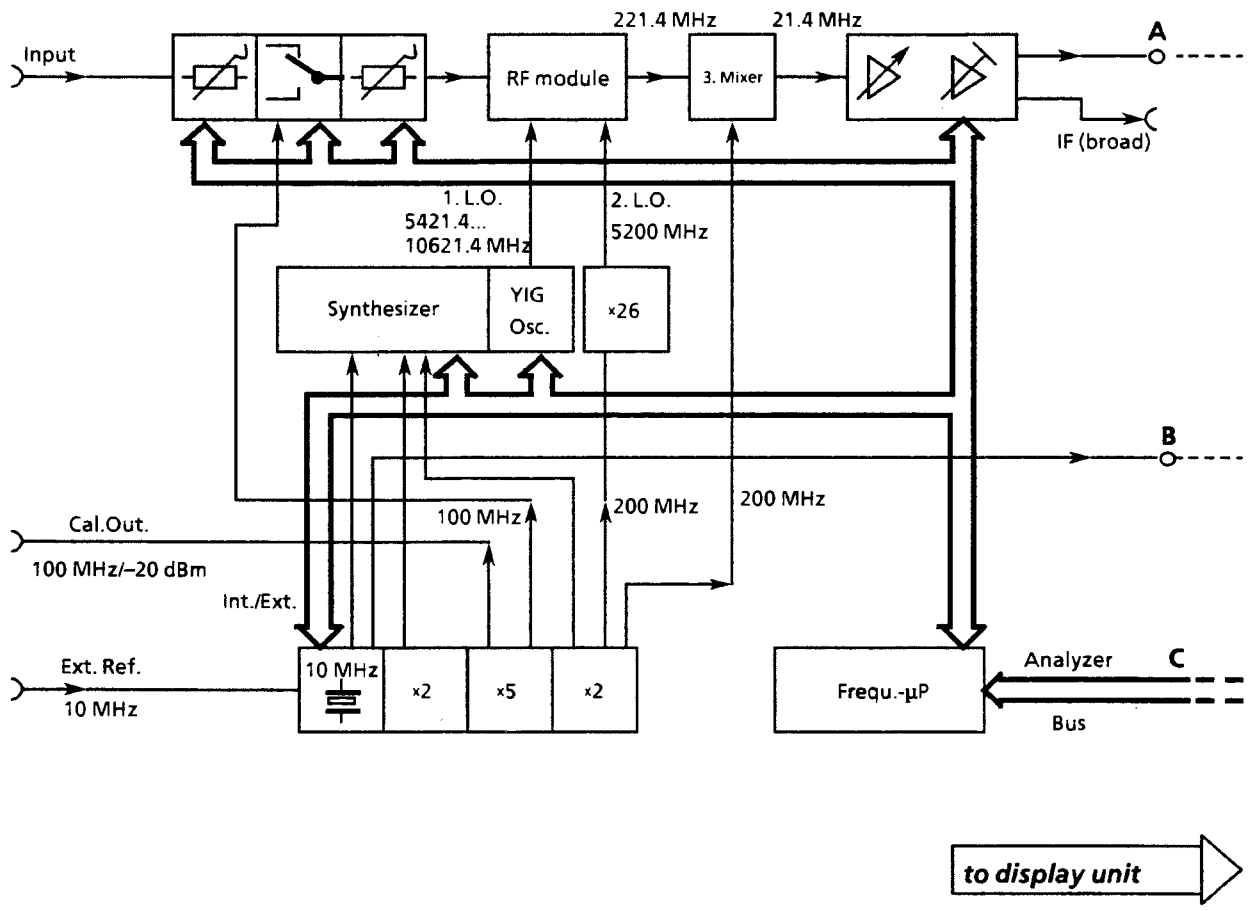

Fig. 2-3 Block diagram of analyzer (RF unit)

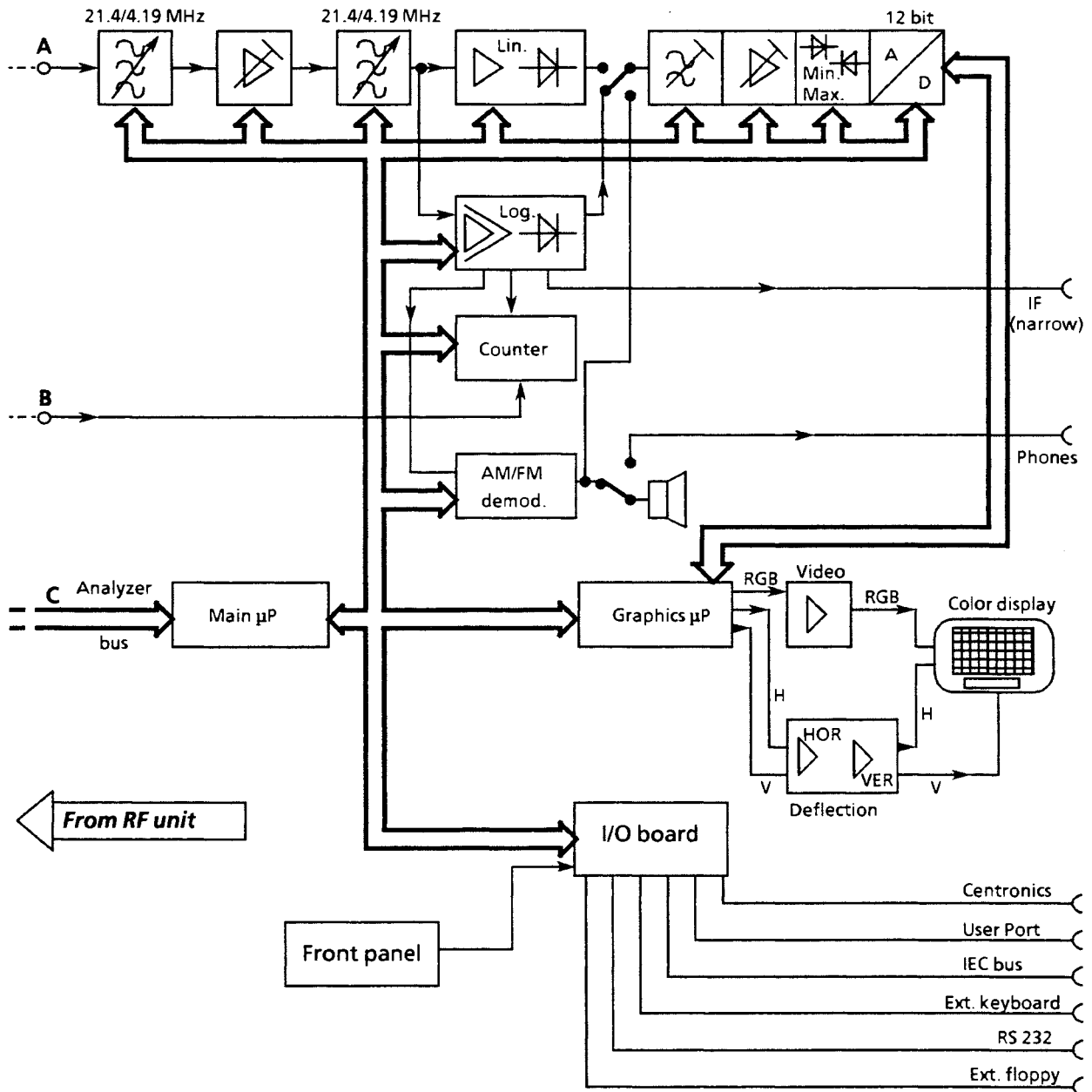
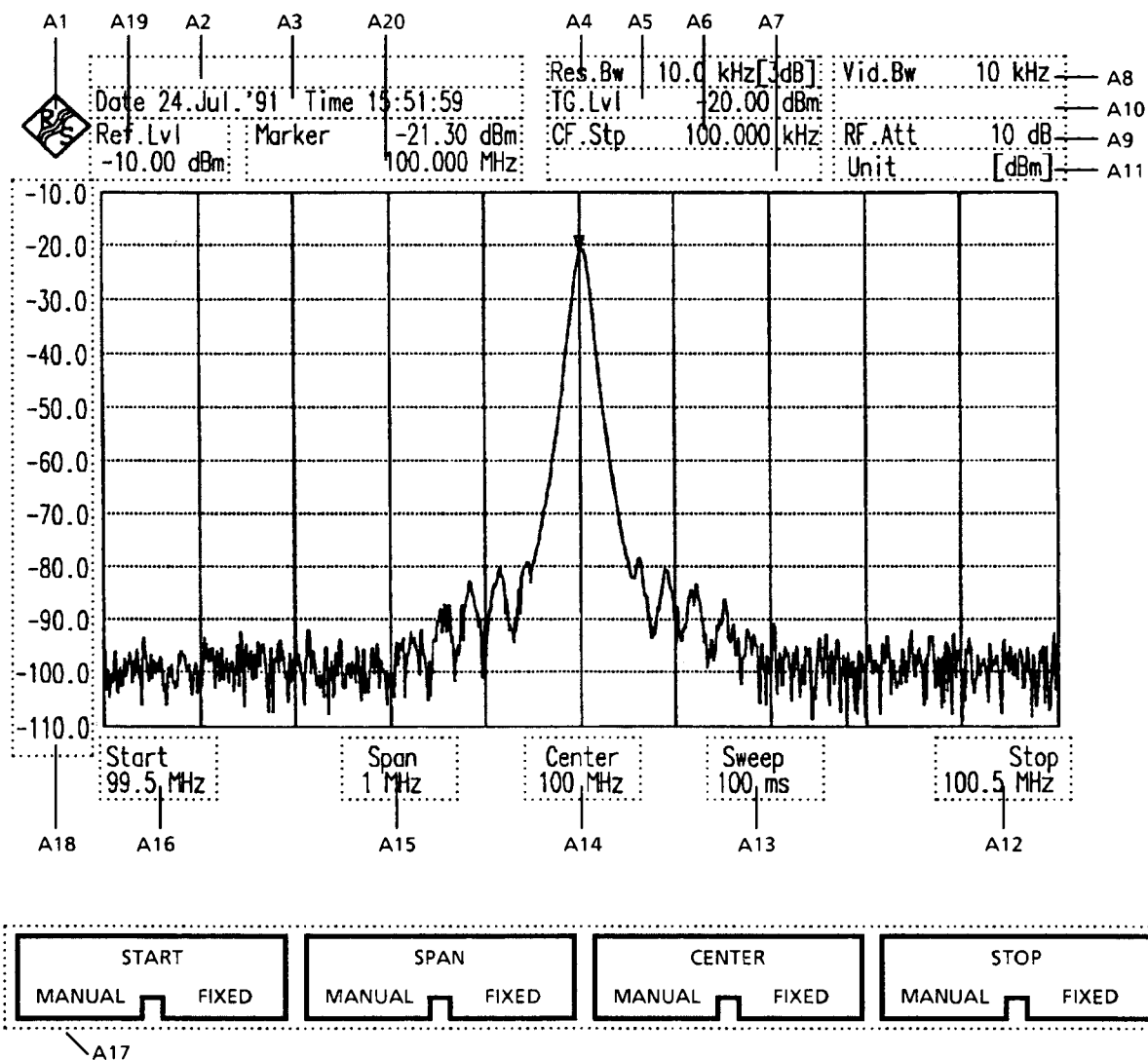

Fig. 2-3 Block diagram of analyzer (display unit)

2.3.6.2 Erklärung des Bildschirminhaltes



- A1 R&S logo can be switched off in the screen menu.
- A2 Status line: This line displays particular operating status and instrument messages (e.g. error messages):
 - FRQOFF: Frequency offset is active
 - LVLOFF: Level offset is active
 - MSG: Instrument message indicating overloads or errors. More detailed information can be obtained using the functions STATUS and ERROR REPORT in the HELP menu.

UNCAL: If the sweep time is not automatically coupled with the resolution bandwidth, i.e. if it is fixed or only manually variable, the resolution filters can no longer settle at small bandwidths and an additional frequency and level error is produced. The resulting erroneous measurement is indicated by UNCAL.

TRIG: The trigger setting is not "Free Run", i.e. the start of the sweep may depend on the signal.

: The symbol "" is displayed in the status line whenever an instrument parameter has been altered during a sweep, i.e. the display of the trace corresponds only partially to the new setting. The

symbol "*" disappears as soon as a complete sweep has been performed without changing parameters.

A20 MARKER: for data associated with the marker(s) (e.g. marker frequency and level), if marker(s) active.

A3 Command line: activated during entries, outputs the current value of the selected parameter and is used to enter new numeric values.

A4 RES BW: display of currently set resolution bandwidth. Usually the 3-dB bandwidth is output, also the 6-dB bandwidth with pulse signals.

A5 TRACKING GENERATOR: level display or "OFF" of tracking generator if it is installed in the instrument.

A6 CF.Stp: display of currently set centre frequency step size.

A7 LINE: display of currently set threshold line, if active.

A8 VID.BW: display of currently set video bandwidth. The 3-dB bandwidth is always output.

A9 RF.ATT: display of set RF attenuation.

A10 MIXER LEV: display of level at mixer required for full deflection to reference line. Calculated from (REF.LEV.) minus (RF.ATT).

A11 UNIT: in the case of long units, e.g. dBV/m/MHz, the symbol "dB*" is used.

A12 STOP: indication of set stop frequency.

A13 SWEEP: indication of set sweep time.

A14 CENTER: indication of set centre frequency.

A15 SPAN: indication of set span.

A16 START: indication of set start frequency.

A17 Function field: 8 function fields assigned to the softkeys.

A18 Scale field: level scale corresponding to set diagram. Either relative or absolute data.

A19 REF.LEV.: level required at socket RF INPUT 37 for full-scale deflection.

2.3.6.3 PRESET

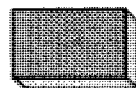

PRESET 43

The following basic setting is called by pressing the hardkey PRESET 43:

Instrument mode Analyzer	Setting	
CENTER FREQUENCY	1000 MHz	
CENTER FREQUENCY STEP SIZE	200 MHz	
SPAN	5000 MHz	
INPUT	AC	
RF.ATT	20 dB	COUPLED
RF.ATT STEPS	5 dB	
REF.LEVEL	-10 dBm	
REF.LEVEL STEPS	10 dB	
LEVEL RANGE	100 dB	LOG
DETECTOR	AUTOPEAK	COUPLED
SWEEP TIME	20 ms	COUPLED
RES.BW	3 MHz	COUPLED
VIDEO BW	3 MHz	COUPLED
SWEEP		CONT.
TRIGGER		FREE RUN
TRACE	1	CLR/WRITE
TRACE	2,3,4	BLANK
REFERENZ		INT.
FREQ. OFFSET	0 HZ	
REF. LEVEL OFFSET	0 dB	

All active special functions are switched off automatically.

2.3.6.4 Explanation of Hardkey Functions and Menus



SCREEN 2

The hardkey SCREEN 2 is used to call the menu to format the screen and to set the colors.

Screen display:

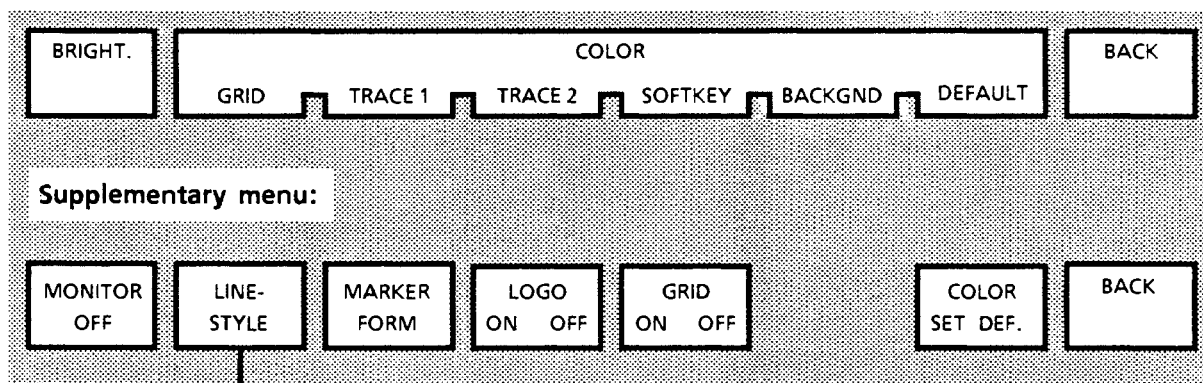

Submenu LINE STYLE:

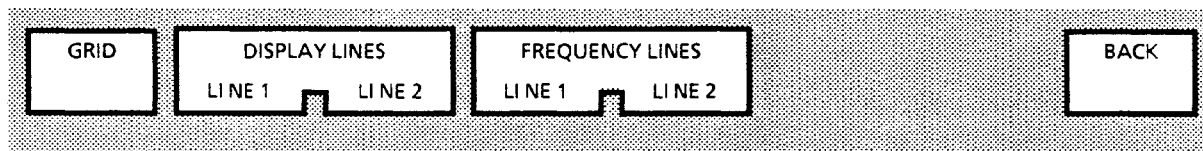

The screen color and intensity are selectable. To set the color, the intensities of the three fundamental colors are displayed as horizontal bars. The spinwheel **32** can be used to change the proportion of the currently active color bar. The colors red, green or blue are selected using the STEP keys **33** and **34**. The inscription of the active color bar is in inverted video. The selected color setting is stored even after switch-off. The preferred setting can also be changed.

Screen brightness.

The screen brightness can be adjusted in 64 steps using the spinwheel **32**:

Counterclockwise: darker
Clockwise: brighter

A colored bar at the top right of the display serves as an indicator.



Color setting for grid.



Color setting for trace 1.



Color setting for traces 2, 3 and 4.



Color setting for the eight softkey labels.



Color setting for the background.

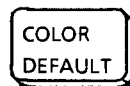

Resetting of modified colors to their preferred settings. A previously activated input is aborted.



Return to last set menu.

Supplementary menu SCREEN



The line oscillator of the internal monitor electronics is switched off and the screen cleared. The signals for the external monitor always remain active! As with the BACK function, the last set menu is automatically selected after switching off the internal monitor. Thus, the respective parameter of the main menu also becomes active again and can be varied via the spinwheel with the monitor electronics switched off.

The monitor is switched on again by pressing any key.



Selection of a submenu to modify the elements for display formatting. The following types of line can be selected:

- continuous
- dashed
- dotted
- dot-and-dashed



Selection of marker symbol using STEP keys **33** and **34**.

The following symbols can be selected:

- ▼ triangle
- circle
- ⊕ cross (vertical)
- ✕ cross (diagonal)



Switching on/off of the R&S logo (A1) in the display.



Switching on/off of the grid lines.



Saving of the current color setting as new preferred setting.



Return to the last set menu.

Submenu LINE STYLE



Selection of grid display.



Selection of display of the two adjustable horizontal level lines 1 and 2.

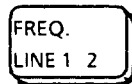

Selection of display of the two adjustable vertical frequency lines 1 and 2.



Return to the last set menu.



DISPLAY 4

Calling the menu for activating the Split-Screen display to represent the measurement results in two display ranges arranged one above the other; the trace storages 1 and 3 can be represented in the upper grid whereas the trace storages 2 and 4 are displayed in the lower grid.

One display range can be active at one time; it is marked by a filled triangle at the upper right-hand margin of the grid. Markers, level lines, tolerance lines, etc. are activated and changed in the currently active display range.

Frequency lines are modified simultaneously in both ranges.

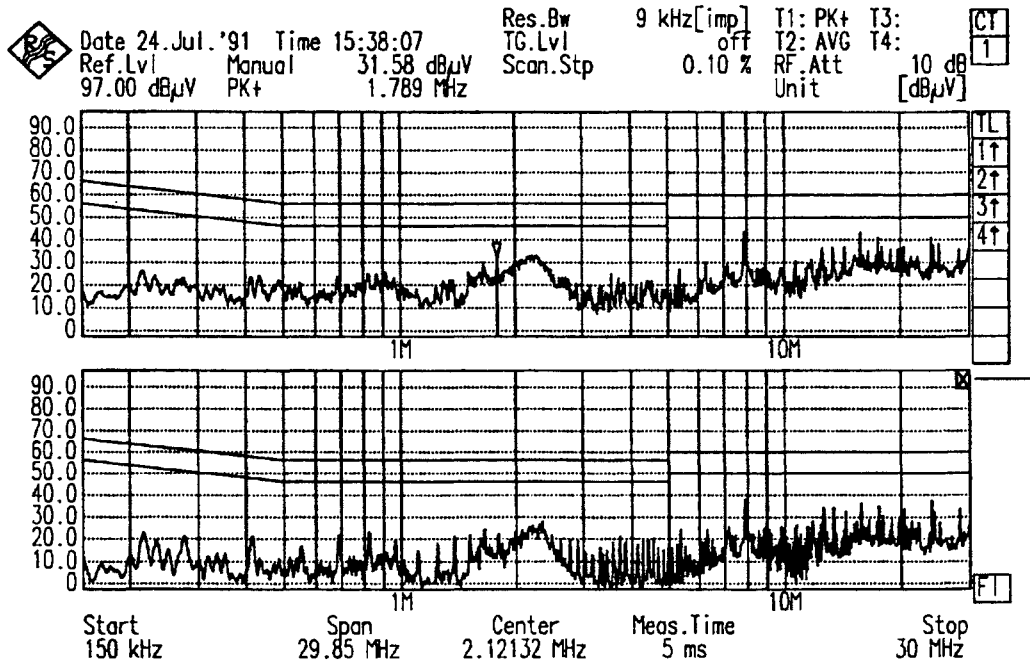

Marking the active display range

Screen display:

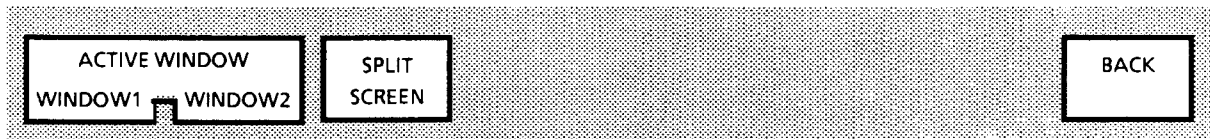

Selecting the upper grid as active display range in the Split Screen display. If markers, level lines, tolerance lines, etc. are subsequently switched on, they are displayed in the upper display range.



Selecting the lower grid as active display range in the Split Screen display. If markers, level lines, tolerance lines, etc. are subsequently switched on, they are displayed in the lower display range.



Switching on and off Split Screen display. When switching on Split Screen display, the level lines, markers, tolerance lines, etc. are displayed again in the display range in which they were activated. Default display range is the upper grid range. When switching off Split Screen display, the level lines, markers, tolerance lines, etc. of the currently active display range are shown in the common grid.



Return to the menu last selected.

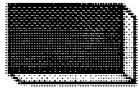

SPECIAL FUNCTIONS 5

Selection of menu for activating additional functions for specific applications.

Screen display:

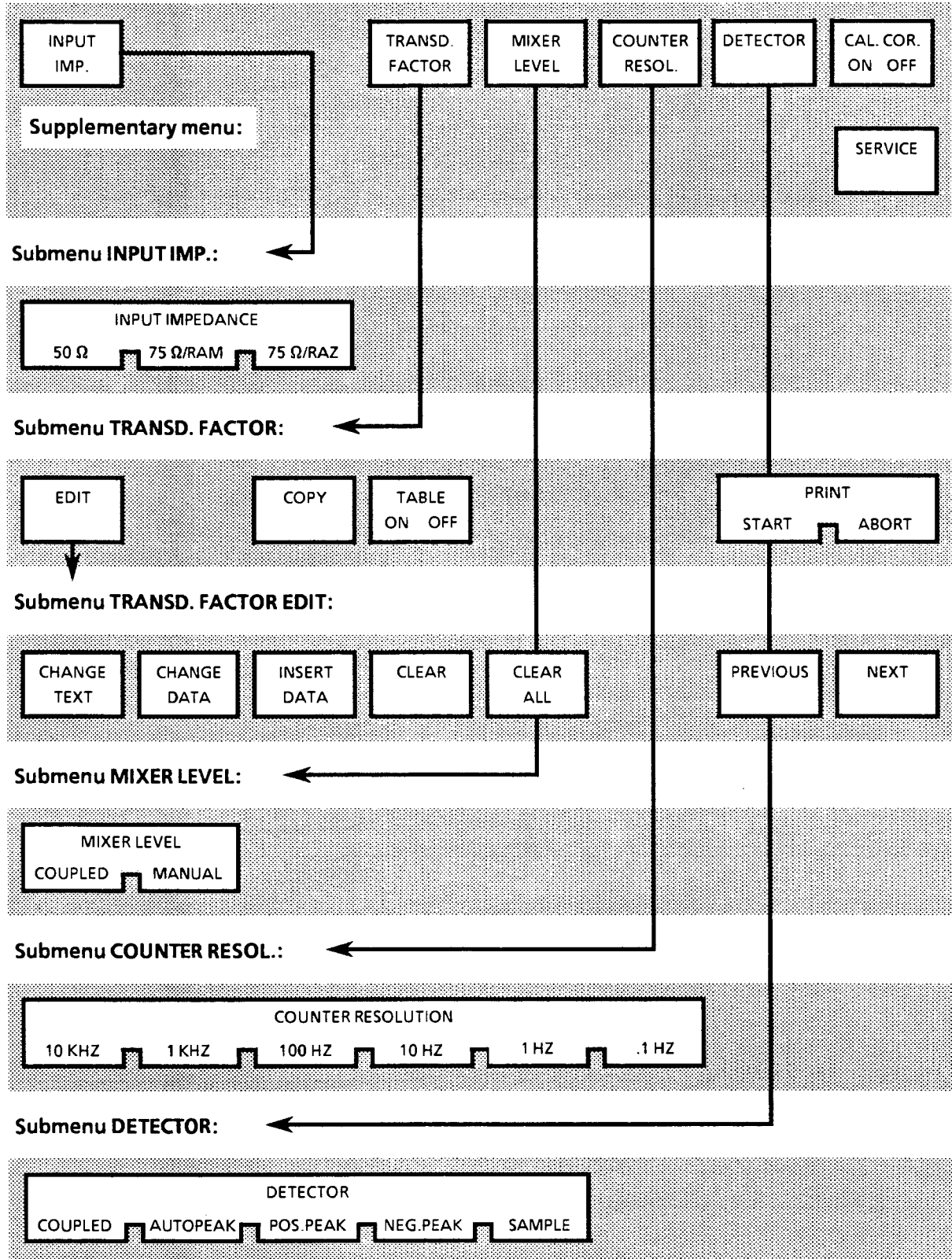

Main menu

INPUT
IMP.

Selection of a submenu for setting the input impedance (50 Ω or 75 Ω using the R&S matching pads).

TRANSD.
FACTOR

Selection of a submenu for selection and input of transducer factors.

MIXER
LEVEL

Selection of a submenu for entering the mixer level.

COUNTER
RESOL.

Selection of a submenu for setting the frequency counter resolution (10 kHz to 0.1 Hz).

DETECTOR

Selection of a submenu for defining the DETECTOR mode.

CAL.COR.
ON OFF

Switching on and off the correction values for level, bandwidth and offset corrections determined in the calibration routine.

Supplementary menu SPECIAL FUNCTIONS

SERVICE

Selection of service routines for checking instrument and board functions for adjustment and service purposes via the numeric keypad. Refer to the Service Manual for details about the complete functions.

Examples:

Function: **Lock Keyboard**
(PRESET and POWER ON)

SF 0.03.00 (Off)
SF 0.03.01 (On)

When the analyzer is remote-controlled via the IEC bus interface, the PRESET key and the ON key are enabled (also following the LLO command). These keys can be disabled using the service function Lock Keyboard.

Function: **Analyzer input**

SF 1.52.00 Input socket RF INPUT
SF 1.52.01 CAL signal (100 MHz, -20 dBm)
SF 1.52.02 Tracking generator (FSAS, FSAC)

The analyzer input can be switched to various sources using function SF 1.52.xx. Normally, the input is connected to the RF INPUT socket (SF 1.52.00). However, it is also possible to through-connect the CAL signal by means of SF 1.52.01, or the output signal of the tracking generator by means of SF 1.52.02.

Note: Functions SF 1.52.01, SF 1.52.02 only provide a correct level display if the RF attenuation is a multiple of 10 dB (to be set in the AUTO menu). The output level of the tracking generator (with SF 1.52.02) always is - 20 dBm, irrespective of the current setting on the analyzer.

Submenu INPUT IMP.

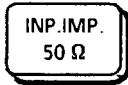

Setting an input impedance of 50 Ω. Each level indication refers to the 50 Ω system.



Setting an input impedance of 75 Ω with the R&S matching pad RAM. Each level indication refers to the 75Ω system (analyzer and RAM).

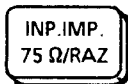

Setting an input impedance of 75 Ω by means of the R&S matching pad RAZ. Each level indication refers to the 75 Ω system (analyzer and RAZ).

Submenu TRANSD. FACTOR

Four different correction tables with max. 25 frequency and level sample points can be defined. These sample points are entered, changed or inserted separately for frequency and level via the numeric keypad. They are displayed in a table, where they are sorted in ascending order of the frequencies. The four correction tables are stored in the battery-backed memory of the analyzer, thus ensuring that they remain stored even after switching off the instrument.

A curve interpolation between the sample points for the current setting of the analyzer is performed for each activated correction curve. Thus the definition of the correction curve can be restricted to the peak values and inflection points. The ranges below the first and above the last defined frequency are not included in the correction.

One or more correction curves can be activated at one time. If several correction curves are simultaneously activated, the aggregate level of all the activated correction curves is considered for the correction.



Selection of a submenu for entering or inserting, changing and clearing sample points in the current correction table.



Copy of the current correction table into another table, which is defined by entering one of the numbers 1 to 4.



Switching on/off of the current correction table. A new curve interpolation with reference to the start and stop frequency is carried out with activating the correction table as well as with each change of the analyzer frequency setting.



Start of a hardcopy-output of the screen contents to the printer via the parallel interface 66.



Abortion of a current output to the printer.

Submenu *TRANSD. FACTOR TABLE EDIT*

CHANGE
TEXT

Input of two text lines with max. 40 characters each serving as comment for the current correction value table is activated. Text input is terminated by pressing again the CHANGE TEXT softkey or using the MENU UP key **23**.

CHANGE
DATA

The sample point *i* selected via the PREVIOUS/NEXT softkeys (represented in the table in reverse characters) may be changed via the numeric keypad, i.e. the value may be altered with reference to the cursor position.

The cursor can be positioned within the scope of the numeric value by means of the spinwheel.

The frequency and/or level value of the current sample point is selected via the BACK SPACE key **28**.

Upon a change of the frequency value the table is sorted again in ascending order of the frequencies.

The edit function is quitted by pressing again the CHANGE DATA softkey or using the MENU UP key **23**.

If the table is empty, this softkey has no function.

INSERT
DATA

New frequency and level sample values can be inserted. The cursor can be positioned within the scope of the numeric value by means of the spinwheel. After having ended the input the table is arranged according to increasing frequencies and is displayed.

The edit function can be quitted by pressing again the INSERT DATA softkey or using the MENU UP key **23**.

When all the table values are assigned, this softkey has no function.

CLEAR

The sample point *i* (represented in the table in reverse characters) is cleared, the table is updated. If the table is empty, this softkey has no function.

CLEAR
ALL

This softkey is used for clearing the whole table.

PREVIOUS

Selection of the next lower frequency sample point in the table. The sample point in question is displayed in reverse characters. If it is the first sample point, the subsequent value is the last sample point of the table ("WRAPAROUND").

NEXT

Selection of the next higher frequency sample point in the table. The sample point in question is displayed in reverse characters. If it is the last defined value in the table, the subsequent value is the first sample point of the table.

Submenu MIXER LEVEL

MIXER LVL
COUPLED

Automatic adjustment of the RF attenuation for the mixer level with reference to the operating modes selected (LOW NOISE, LOW DISTORTION or NORMAL).

MIXER LVL
MANUAL

The rated mixer level can be entered via the numeric keypad, the step keys or the spinwheel. It is set by means of the RF attenuation, i.e. the COUPLED MODE must be selected for the RF attenuation. In the LOW DISTORTION mode the mixer level is set in steps of 1 dB – whereas in steps of 5 dB in the other modes – referred to the reference level. The mixer level is always lower than the reference level.

The rated mixer level is indicated in the display field (A 10) above the grid.

Note:

The special function MIXER LEVEL MANUAL is disabled (COUPLED mode) in the operating modes LOW DISTORTION, LOW NOISE and NORMAL.

Submenu COUNTER RESOLUTION

CNT. RES.
10 KHZ ... CNT. RES.
0,1 HZ

Setting of resolution of built-in counter from 10 kHz to 0.1 Hz with corresponding gate time. The resolution of the counter result in the marker field corresponds to the resolution of the counter.

Submenu DETECTOR

Selection of DETECTOR mode for special applications.

COUPLED

Automatic selection of the detector mode depending on the active write mode of the traces.

Clear Write = AUTOPEAK
Max Hold = Pos.PEAK
Average = Sample

AUTOPEAK

Automatic switchover between maximum and minimum peak detector depending on the input signal (noise or signal edges).

POS.PEAK

Fixed selection of positive peak-value detector.

NEG.PEAK

Fixed selection of negative peak-value detector.

SAMPLE

Fixed selection of random sample mode without peak detectors connected ahead (as with AVERAGE mode).



DISPLAY LINE 6

The hardkey DISPLAY LINE 6 is used to select a menu to activate additional level/frequency or tolerance lines.

The status of the corresponding element is displayed by an inverted (=activated) representation of the softkey field.

The frequency and level values of the activated lines can be displayed and printed out in tabular form using the STATUS function in the HELP menu.

Screen display:

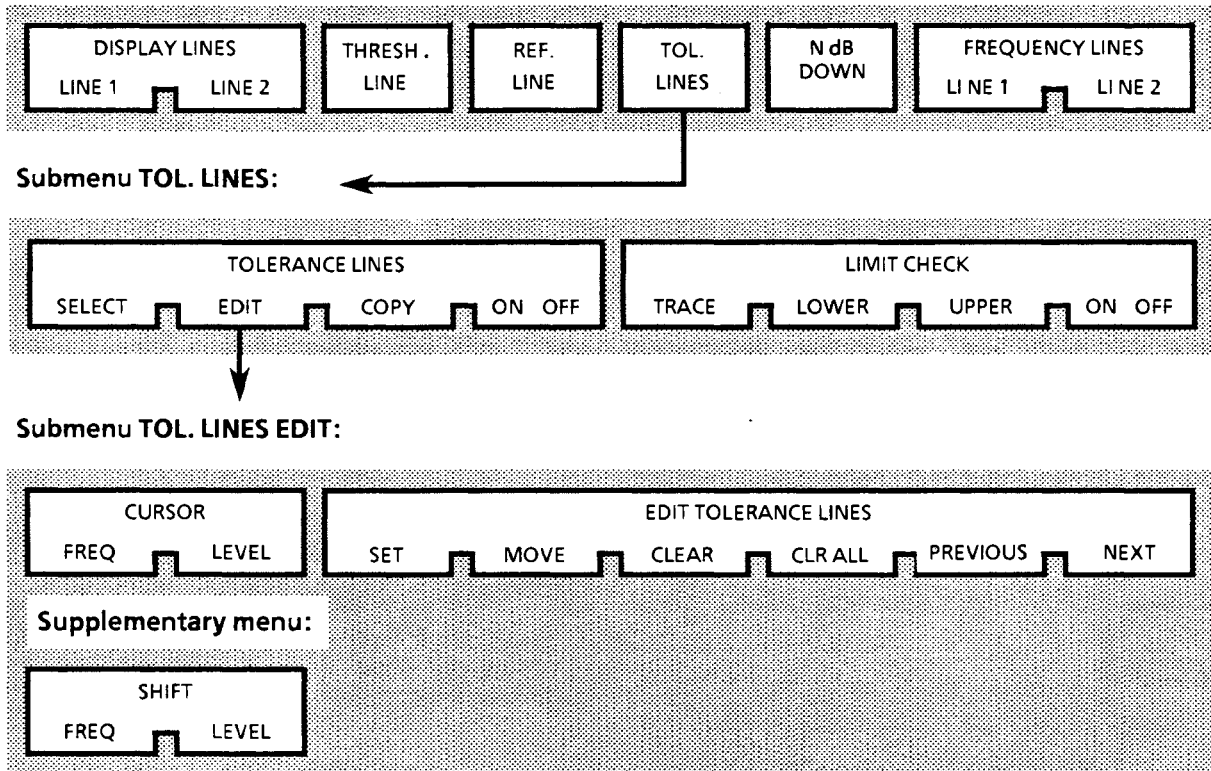

Main menu



DISPLAY
LINE 1 2

Switching on/off of two lines whose position can be changed using the spinwheel 32, the STEP keys 33, 34 or by a numeric input 31. The level value of these lines is displayed on the screen. Pressing the softkey again switches off the function.



THRESH.
LINE

Switching on and off of a level line used to define a threshold value. This threshold value can define a lower limit for the marker function NEXT PEAK or the multimarker function PEAK SEARCH or suspend automatic signal tracking for the function SIGNAL TRACK when the limit value has fallen below.



Switching on/off a level line used for difference mode and normalization (elimination of frequency responses). Pressing the softkey again switches off the function.



Selection of a submenu for selection and input of max. 8 tolerance lines and for activating the LIMIT CHECK.



One level line is set to the peak value, the second level line is set n dB below the peak value of the signal. When searching for the peak, the level is excluded at a frequency of 0 Hz. The level can be changed using the spinwheel, the STEP keys and by directly entering numbers. The value is displayed in the command line. The two lines are switched off again by pressing the softkey again.



Switching on/off of two frequency lines, the position of which can be changed using the spinwheel, the STEP keys or by directly entering numbers. The lines are switched off by pressing the softkey again.

Submenu TOL. LINES

Max. 8 tolerance lines with max. 16 sample points can be defined. After each sweep a LIMIT CHECK can be carried out. The sample points are frequency and level values, which can be positioned or changed interactively via spinwheel or STEP keys by means of cursor control. They can also be defined by numeric inputs. The tolerance lines are no graphic lines but actually defined frequency and level values. Upon change of the instrument setting (frequency or reference

level) the tolerance lines are automatically adapted and, if necessary, clipped, i.e. they do not exceed the grid, even if the physical definition range is beyond the instrument setting.

Limit Check is indicated beside the grid, the active tolerance lines being displayed with their numbers and additionally with an arrow facing upwards or downwards in case of limit check. A limit violation is indicated by a change of the inscription color. With the respective configuration a Service Request may be sent from the IEC bus (s. Section 2.4).

Note:

The tolerance lines are all stored in the battery-backed CMOS RAM of the analyzer and are not lost in case of switch-off.



Selection of one of the tolerance lines 1 to 8 by entering the respective number. The current tolerance line is indicated in the command line.



Selection of a submenu for entering, inserting, changing or clearing sample points for the current tolerance line.

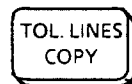

Copy of the current tolerance line to another tolerance line defined by entering the respective number (1 to 8).

TOL. LINES
ON OFF

Switching on/off of the current tolerance line. With activating the tolerance line as with each change of the frequency and level setting or change of the analyzer level range an adaptation of the tolerance lines with reference to the start and stop frequency is carried out.

LIMIT CHK
TRACE

Selection of the trace (1 to 4) for limit check of the current tolerance line.

LIMIT CHK
LOWER

With activating the limit check the *current(ly active)* tolerance line is defined to be the bottom limit line, i.e. values below this line violate the limit.

LIMIT CHK
UPPER

With activating the Limit Check the current tolerance line is defined to be the top limit line, i.e. values above this line violate the limit.

LIMIT CHK
ON OFF

Switching on/off of Limit Check with the current tolerance line for the trace selected at the end of the sweep. The result is then indicated beside the grid, i.e. the number of the tolerance line with the arrow facing upwards or downwards (depending on the limit lines selected) is displayed with the respective color.

Submenu TOLERANCE LINES EDIT

This submenu is selected for entering, changing or clearing the current tolerance line via cursor control. The curve segments of the tolerance line which change due to a variation of the current sample point, are dashed

For first editing a new tolerance line the cursor is positioned in the center of the display, whereas it is located on the last sample point for all further editing procedures. The cursor can only be moved along the frequency or the level axis. Exact positioning is possible by entering numbers.

Entering a new tolerance line:

A tolerance should be defined from "the left to the right", i.e. from low to high frequencies. After positioning the cursor to the first sample point, the latter is fixed using the SET softkey. The MOVE softkey is activated simultaneously (for defining the next sample point!). The position of the second sample point is also fixed with the SET softkey. The tolerance line is completed in this way – the end of the line is fixed by pressing the MOVE softkey again.

Changing a sample point:

The cursor can be positioned along the tolerance line to the various sample points using the softkeys PREVIOUS and NEXT. The sample points can then be varied by pressing the MOVE softkey. Frequency changes are limited by the respective sample points to the left and to the right.

Insertion of an additional sample point:

The additional sample point is defined by means of the cursor. The new point is integrated in the polyline by means of the SET softkey and saved by actuating the MOVE softkey.

Deletion of a sample point:

The cursor is positioned to the required sample point by means of the softkeys PREVIOUS or NEXT. By pressing the CLEAR softkey this sample point can then be deleted.



If the cursor is positioned on a sample point of the tolerance line, this point is deleted from the active polyline.



Switchover to the frequency value of the cursor position. The frequency can be changed via the spinwheel, the STEP keys or via the numeric keypad.



The current tolerance line is deleted, the cursor is placed in the center of the screen.



Switchover to the level value of the cursor position. The level can be changed via the spinwheel, the STEP keys or via the numeric keypad.



The cursor is positioned to the next lower frequency sample point of the current tolerance line.



Marking a new sample point for the current tolerance line. The MOVE mode is immediately activated. If the cursor is positioned between two sample points of the tolerance line, the new sample point is automatically inserted in the polyline.



The cursor is positioned to the next higher frequency sample point of the current tolerance line.

Supplementary menu TOLERANCE LINES EDIT



With the MOVE mode activated the current sample point position can be changed by means of the cursor. With the MOVE mode not activated and the cursor positioned to a sample point, the MOVE mode can be activated by pressing the respective softkey. The cursor position thus determines the current sample point, which can change its position as well. If the cursor is not positioned to a sample point, this softkey has no function. The MOVE mode is deactivated by pressing the softkey again.



The current tolerance line can be varied within the frequency axis via spinwheel or STEP keys.



The current tolerance line can be varied within the level axis via spinwheel or STEP keys.



PLOT 7

These functions can be used to output hardcopies on a printer.

The printer and plotter are selected in the menu SETUP. The printer or plotter output takes place in the background from a sufficiently large buffer memory so that the analyzer is ready again for new measurements after a few seconds.

For colored printer or plotter outputs, e.g. PDN COLOR, the buffer memory is occupied several times, thus increasing the time period which passes until the instrument is ready again for new measurements.

Note:

The output to the plotter is carried out in the controller mode via the IEC-bus interface. With an external controller attached or with the internal controller function FS-K1 activated the output to the plotter is initiated by a corresponding IEC-bus command, which transfers the controller function to the analyzer (see example in Section 2.4.1.9). When an external controller is attached, the output to the plotter cannot be manually started in order to prevent a collision of active controllers at the IEC bus.

Screen display:



Start of hardcopy output of screen contents on printer via parallel interface **66**.

If the "PDN COLOR" or "PAINTJET COLOR" option has been selected in the SETUP menu, the current color of the screen elements is output on a color printer. The color can be changed in the SCREEN menu.

With this setting the background is not printed, the "white" color is printed black, the "black" color is not printed. For all further colors the respective red, green and blue portion is added with printing, when the intensity is higher than 50%.



Start of hardcopy output of complete screen contents including grid and inscriptions on plotter via IEC-bus interface **61**.



Start of output of the visible TRACE memory (memories) on plotter via IEC-bus interface **61**. This is particularly important for repeated measurements with unchanged instrument settings.



Instead of the softkey menu, two lines of text with 84 characters each can be entered using the external keyboard. The text entry is terminated by pressing the MENU UP key 23.



Abort current output on printer or plotter.

This has no effect on the buffer memories (of variable size) in the printers.



Return to the last menu selected.

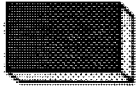

HELP 8

The hardkey HELP 8 is used to call functions which inform the operator of further instrument functions available, identify the current instrument status and enable access to calibration routines.

Note:

Additional calibration functions are available for the operating modes 'Receiver' and 'Scalar Network Analyzer'.

They are described in the manual section for the respective mode.

Screen display:

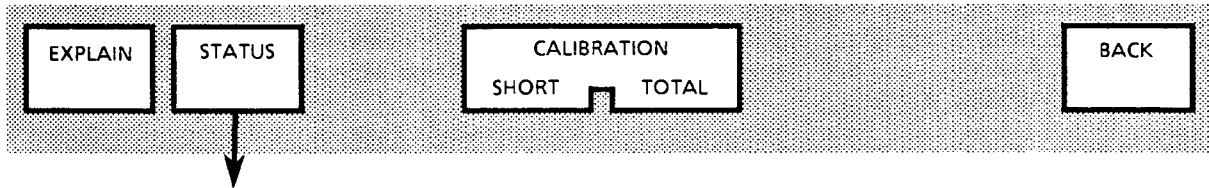

Submenu STATUS:

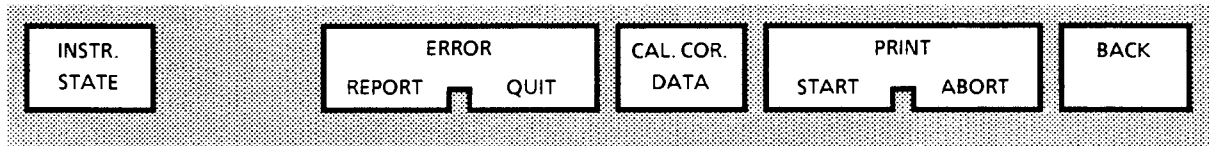

Main menu



General information on instrument function and special facilities offered by the softkey menu selected before. The respective functions are illustrated.



Selection of a submenu which permits to list the current instrument data, error messages and calibration correction values. These tables can be output via a connected printer.



Triggering of a short calibration. A level calibration is carried out at a frequency of 100 MHz and an offset correction of the resolution filter performed.



Triggering of the total calibration. In this case the 3-dB and 6-dB bandwidths are also calibrated for all resolution bandwidths as well as the amplitude deviations and any frequency offset. The amplifiers connected in series and the logarithmic and linear display ranges are also calibrated. Besides the offset display of the FM demodulator is also calibrated.

Note:

Actuating the PRESET key during total calibration causes all data stored in the CMOS RAM to be cleared. The instrument switches to the default setting with the initialization display. This "cold start" corresponds to the instrument setting after replacement of the battery.

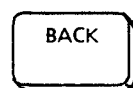

Return to the last menu selected.

Submenu STATUS

ERROR
QUIT

Cancels and clears messages on the ERROR REPORT display.

INSTR.
STATE

Output of current instrument status in tabular form on the screen. If active, the following elements are listed:

- Markers (ref., delta and multimarker)
- Display lines (level lines, frequency lines, etc.) with frequency and/or level values as well as the current TRIGGER setting (free run, video, etc.). Refer also to the example on the next page.

CAL. COR.
DATA

Output of all correction values determined by the internal calibration routine. The display is made in tabular form on the screen on a total of five pages. The STEP keys can be used to switch between the individual table pages.

ERROR
REPORT

Output of messages (e.g. overload) in tabular form on the screen by displaying "MSG" (message) in the status line A2. The messages that have occurred after the last ERROR QUIT (or PRESET) are listed for RF unit and display unit separately. Messages that have been added after the last selection of the function ERROR REPORT are distinguished in terms of color.

Refer also to the example on the next page.

Note:

Sweep is stopped during status output. Thus error messages of synthesizers or overload are not indicated.

Example: INSTRUMENT STATE with marker, multimarker and display lines.

INSTRUMENT STATE				
Ref.	Marker	100.00111111 MHz	-20.20 dBm	Trigger
Delta	Marker	100.30444444 MHz	-105.27 dBm	
Multi	Marker 1			
Multi	Marker 2			
Multi	Marker 3			
Multi	Marker 4			
Multi	Marker 5			
Multi	Marker 6			
Display	Line 1	-49.76 dBm		
Display	Line 2			
Threshold	Line			
Reference	Line			
N dB down	Line			
Frequency	Line 1			
Frequency	Line 2			
Ref. Lvl.	Offset 0 dB			
Frequency	Offset 0 Hz			
T.G. Lvl.	Offset 0 dB			
T.G.Freq.	Offset 1.000000 MHz			

Example: ERROR REPORT with overload message

ERROR REPORT	
RF UNIT:	DISPLAY UNIT:
LEVEL 2. IF	A34

If a significant deviation from the internal correction values occurs during the calibration procedure, the respective parameter is marked in the table by the remark "check". A correction of this deviation is carried out (exception: tracking level, AF unit and bandwidths may show deviations, which cannot be corrected).



Start of hardcopy output of screen contents on printer via parallel interface 66.

Additional tests are performed during total calibration (e.g. calibration level present?) in order to ensure an error-free run of the calibration routine. Calibration is aborted in case of a machine error. This is indicated in the table by the message "Calibration:aborted".



Aborts a currently running printer output.



Return to the last menu selected.

Example: CALIBRATION DATA

Use ↑ ↓ keys to Page Up/Down	CALIBRATION DATA		Page 1 of 6
Calibration : passed Calibration Date : 06-04-90	Bandwidth 6 Hz : passed 10 Hz : passed 30 Hz : passed 100 Hz : passed 180 Hz : passed 300 Hz : passed 500 Hz : passed 800 Hz : passed 1 kHz : passed	Bandwidth 1 kHz : passed 3 kHz : passed 10 kHz : passed 20 kHz : passed 30 kHz : passed	
Preamplifier : passed Step Gain 10.0dB : passed Step Gain 1.0 dB : passed Step Gain 0.1 dB : passed LIN : passed LOG : passed			
AF Unit : passed Tracking Level : passed Attenuator : passed		Bandwidth 80 kHz : passed 100 kHz : passed 300 kHz : passed 1 MHz : passed 3 MHz : passed	

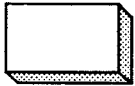

SWEEP 9

The hardkey SWEEP 9 can be used to define the parameters for frequency sweep (time, start, single sweep etc.).

Screen display:

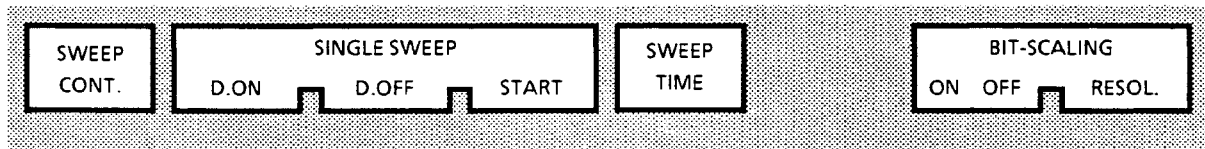

The current sweep is interrupted when this softkey is pressed and subsequently restarted automatically. The continuous sweep, i.e. an automatic restart once a sweep has been completed, is the normal sweep form.



Triggers the start of the sweep in SINGLE SWEEP mode.



Switches to operating mode SINGLE SWEEP.



The sweep time can be changed using the spinwheel, the STEP keys and by directly entering a number. Pressing the SWEEP TIME key removes the sweep time from the coupled functions and retains the set value in fixed mode.



DISPLAY OFF can be used to switch off the screen for one sweep. The measurement is then only started when the START softkey is pressed. The screen is switched off immediately before the sweep is started. It is switched on again automatically at the end of the sweep. The measured curve is visible immediately.

Advantage: Interference from built-in monitor is avoided!

The sweep time can be entered between 20 ms and 1980 s if the span is >0 Hz. With zero span, the sweep time can be additionally reduced to

- 10 ms
- 8 ms
- 4 ms
- 2 ms
- 1 ms
- 800 μ s
- 400 μ s
- 200 μ s.

With sweep times <8 ms, no longer 901 but accordingly less test points are displayed, and the trace is graphically interpolated.



(only span = 0)

Allows the display of time-related display values (e.g. deltamarker time) in the bit scaling.



(only span = 0)

The resolution of the bit scaling can be modified by entering the time period of a bit. Values ranging from 1 ns to the maximum sweep time are permissible.

The rotary spinwheel, STEP keys or direct entry of numbers can be used for input.



TRIGGER 10

Selection of menu to adjust triggering of the sweep.

If the trigger setting is not FREE RUN, "TRIG" is displayed in the status line A2.

Screen display:



The sweeps are triggered in continuous or free-running mode.



Triggered by external signal.



Triggered synchronous to frequency of AC supply voltage.



Trigger slope selection. The current sign is displayed by inverting the softkey field. This function is only relevant to the operating modes TRIGGER EXTERNAL and TRIGGER VIDEO.



Triggered by video signal. The trigger threshold is displayed as a dashed level line in the diagram and can be varied using the spinwheel. The trigger line disappears when the menu is left.

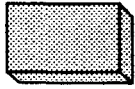

TRACE 11

Selection of menu for selection of the current TRACE memory. The traces 1 to 4 can be selected by entering the respective number. All softkey functions mentioned apply for the current TRACE indicated in the command line (A3). The operating modes CLEAR WRITE, MAX HOLD and AVERAGE are provided for active writing to the trace memory.

Each trace record consists of the measured values and the associated instrument setting. The function SAVE 1 to 4 allows for storing the TRACES 1 to 4 together with the instrument setting. The TRACE data are not cleared in case of switching off the instrument.

Note:

The diagram inscription (frequency and level axis) always corresponds to the current hardware setting of the analyzer. In VIEW mode the marker indicates the measured values of the curve. They may differ from the current instrument setting.

TRACE 1 can be written to or displayed separately from the other trace memories. It is then displayed on the screen by a separation in terms of color. Only in VIEW mode traces 3 and 4 are displayed graphically. Writing is, however, possible in all modes but not displayed.

Screen display:

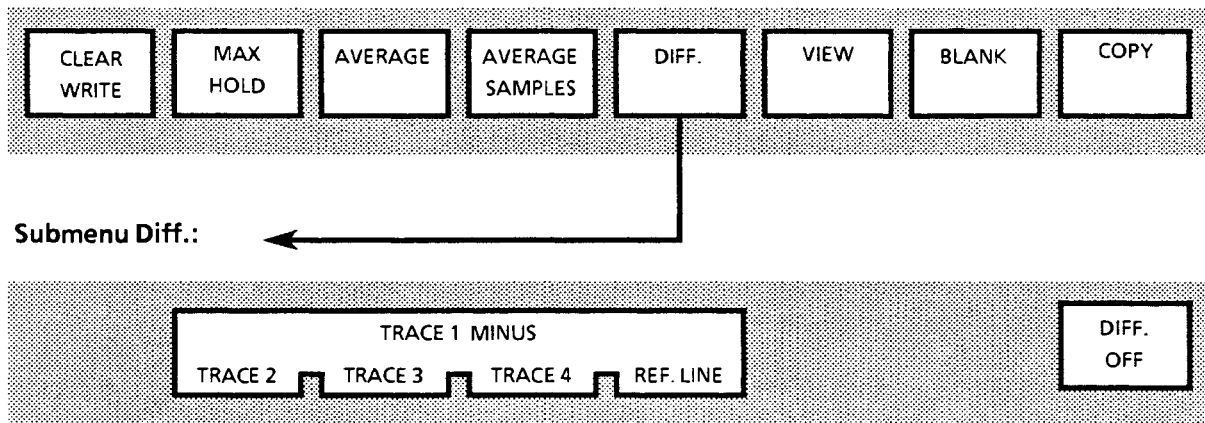

The current TRACE is cleared and the sweep restarted. With each sweep the TRACE is rewritten to. Switching TRACE 2 into the CLEAR/WRITE mode causes TRACES 3 and 4 to enter the BLANK mode, if they were displayed earlier in VIEW mode.



With each sweep the max. value resulting from the addition of the new measured value and the stored trace data is transferred to the current trace. The trace memory is cleared and the procedure is restarted by pressing the softkey again.



The average value is calculated from several sweeps and stored in the current trace. The first sweep after activating this function or after changing the instrument setting is performed with CLEAR/WRITE, then the average value is determined according to the formula

$$Y(n) = \frac{(n-1)}{n} \times Y(n-1) + \frac{1}{n} \times Y(\text{new})$$

where n is the number of average samples.

If AVERAGE SAMPLES = 0, n = 10.

The number of average samples for the



AVERAGE mode can be determined by entering numbers up to max. 32767. If the number of average samples = 0 (preferred setting) continuous averaging is performed by applying the above-mentioned formula with n = 10. In SINGLE SWEEP mode the new sweep is thus averaged with the trace contents.

If the number of average samples n = 1 to 32767, n sweeps are performed and averaged. A single sweep thus consists of the number of sweeps entered which are then averaged.



Selection of submenu for forming the difference of trace 1 and the other traces or the reference line.



VIEW is used to display the current trace memory and for writing to the trace. Switching trace 3 or 4 to VIEW mode causes trace 2 to be switched to VIEW mode also, if it has been written to earlier.

Only in VIEW mode these traces can be displayed together.



BLANK is used to clear the current trace memory on the screen. The stored trace contents is retained and can be displayed again using VIEW.

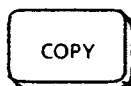

Copy of the current trace memory into another one, which is defined by entering one of the numbers 1 to 4. This trace memory is then automatically switched to the VIEW mode.



With the sweep stopped, the difference between trace 1 and traces 2 to 4 or the reference line is formed and stored in memory 1 again. During the sweep, the stored curve or the reference line is subtracted from the current measured value. If the difference mode is activated, all other measurements (max. hold, average) refer to this difference.

If the reference line is switched on during formation of the difference between trace 1 and traces 2 to 4, this procedure is referred to as normalization with the reference line being the 0-dB reference. The diagram labelling is switched to "relative". This 0-dB reference can be changed by shifting the reference line.



Switching off of difference mode.

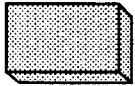

MULTI MARKER 12

This function permits the use of a maximum of eight markers, marker 1 being always used as reference marker and marker 2 as delta marker so that the remaining six multimarkers can be set independently.

The frequency and level values of the active markers can be displayed and printed out in tabular form using the function STATUS in the HELP menu.

Note:

The multimarkers are not active in mode 'Receiver' and with ZERO SPAN.

Screen display:

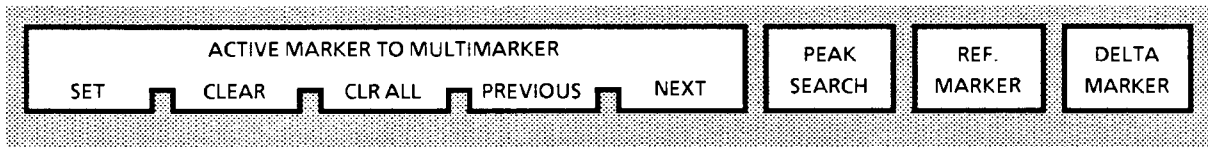

Sets the next multimarker (in increasing sequence) to the current marker position.



Clears the set multimarker if the active marker is at this position.



Clears all set multimarkers.

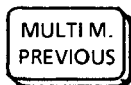

Sets the active marker to the position of the next multimarker with smaller frequency, if available.



Sets the active marker to the position of the next multimarker with greater frequency, if available.



Sets all six multimarkers to the six greatest signals in the spectrum. The frequency 0 Hz, if visible, is excluded from the search for the peaks. The threshold line can be activated in order to determine a threshold value representing the lower limit for the peak search. Depending on the threshold value and signal spectrum, it is also possible to set less than six multimarkers.



Activates the reference marker. The marker frequency can be changed using the STEP keys, the spinwheel or by entering numbers. For switching off, the softkey must be pressed again.



Activates the delta marker. If the delta marker has not been switched on before, the marker is automatically set to the greatest signal. The marker frequency can be changed using the STEP keys, the spinwheel or by entering numbers. The level and frequency difference between the delta marker and the reference marker is output in the marker field (A20) on the display. For switching off, the softkey must be pressed again.

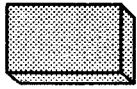

MARKER 13

This function enables use of level/frequency markers.

The frequency 0 Hz is excluded from the search for the peaks.

Pressing **MARKER 13** automatically triggers the search for and identification of the maximum value on the trace if the marker has not already been activated.

Screen display:

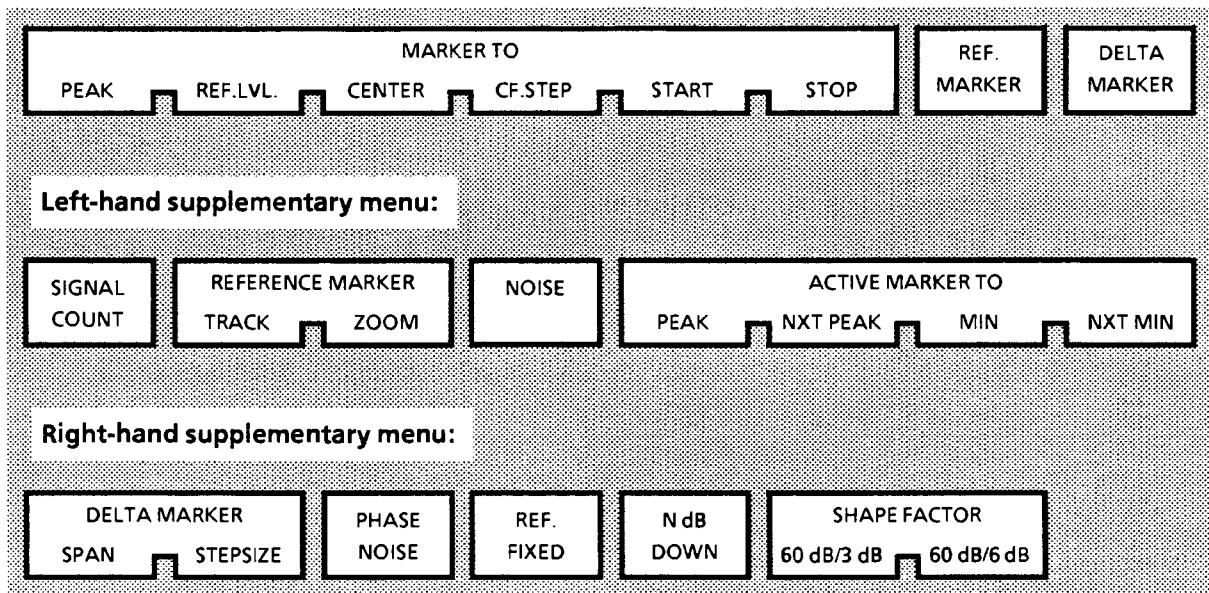

Main menu

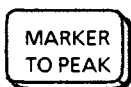

The marker is positioned to the peak signal of the spectrum (PEAK SEARCH).



The current marker frequency becomes the new center frequency.



The current marker level becomes the new reference level.

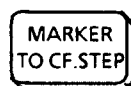

The marker frequency becomes the new step size of the center frequency. (Important with harmonics measurements!)

It is overwritten when the span is modified, unless automatic coupling is switched off.



The marker frequency becomes the new start frequency.



The marker frequency becomes the new stop frequency.



Activates the (reference) marker. The marker frequency can be changed using the STEP keys, the spinwheel or by entering numbers. For switching off, the softkey must be pressed again.



Activates the delta marker. PEAK SEARCH is carried out automatically if the delta marker has not been switched on before. The level and frequency difference between the delta marker and the reference marker is indicated in the marker field (A20) of the display. For switching off, the softkey must be pressed again.

Left-hand supplementary menu MARKER



The sweep is performed until the marker position is reached. Then the frequency is measured using the built-in frequency counter and output in the marker field (A20) of the display. The sweep is automatically continued after completion of the measurement. The process is automatically repeated until the function is switched off by pressing the softkey again, or the marker position is changed.

With reference marker and delta marker switched on, the frequency is measured at both positions and the difference is then indicated in the marker field (A20).

Note:

The largest signal within the resolution bandwidth is always counted. If the resolution bandwidth contains several signals, the frequency range can be limited to ensure that the desired signal has the largest amplitude. The minimum countable amplitude must be at least 10 dB higher than the noise.



This function enables automatic tracking of the analyzer center frequency with drifting signals. It corresponds to the function AUTO TRACK. PEAK SEARCH and MARKER TO CENTER FREQ are carried out following each sweep. This procedure is only possible as long as the drifting signal remains within the display range of a window on the screen or, with active threshold line, the signal level exceeds the threshold value. Otherwise, tracking is interrupted but remains active.



Activates the ZOOM function about the marker. The input of the span is activated. If the span is entered, the sweep is stopped at the marker position and the frequency measured using the built-in IF counter. Then the measured frequency becomes the new center frequency and the span is set as required.

This function is helpful in particular if a signal is to be immediately analyzed with a high resolution from a large span. The function corresponds to the AUTO ZOOM function.

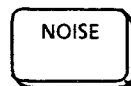

The phase noise is measured at the marker position, the bandwidth and all necessary correction factors being taken into account. The phase noise is output in the marker field (A20) of the display in dBm/Hz.



The marker is set to the greatest signal in the spectrum. The signal at the frequency 0 Hz, if visible, is automatically excluded if the threshold line is not active or its level is smaller than the greatest signal in the spectrum.



Each time the key is pressed, the marker is set to the next (smaller) maximum. The signal at the frequency 0 Hz, if visible, is automatically excluded. By activating the threshold line, it can be used to determine a threshold value representing the lower limit in the search for the peaks.



The marker is set to the smallest signal value in the spectrum.



Each time the key is pressed, the marker is set to the next (greater) minimum. By activating the threshold line, it can be used to determine a threshold value representing the upper limit in the search for minima.

Right-hand supplementary menu MARKER

When this menu is selected, the delta marker is automatically activated if it was not already switched on before.



The frequency difference between the two markers becomes the new span. The marker frequencies become the new start and stop frequency. The function is disabled with Zero Span.



The frequency difference between the two markers becomes the new step size by which the delta marker can be varied using the STEP keys. The function is disabled with Zero Span.



Level line 1 and frequency line 1 or time line 1, respectively, are set to the level/frequency value of the reference marker.

The difference between the point of intersection of level and frequency line and the marker is determined and output in dBc/Hz in the marker field (A20) of the display, the current noise bandwidth and the correction factors being taken into account. Adjustment is also possible by REFLVL.



Using this function, level line 1 and frequency line 1 or time line 1, respectively, are set to the level/frequency value of the reference marker. The difference between the point of intersection of level and frequency line and marker is output in the marker field (A20).

The position of the level and frequency line can also be changed in the DISPLAY LINE menu, thus enabling level and frequency measurements with reference to a point outside the measuring curve. The two lines are switched off by pressing this softkey again.



In addition to the reference marker, two further markers are activated whose level is N dB smaller. The level value can be changed using the STEP keys, the spinwheel or by entering numbers. The frequency difference between these markers is output in the marker field. When this function is activated, all other multimarkers are switched off. If the N dB value cannot be formed (e.g. if the signal approaches the noise level), "invalid BW" is displayed in the marker field (A20). The function is disabled with Zero Span.



In addition to the reference marker, four further markers are activated the level value of which is 3 dB/60 dB smaller. One marker of each pair is smaller in frequency than the reference marker and one marker is greater in frequency. The shape factor of the analyzed signal is output in the marker field (A20) of the display. When this function is activated, all other multimarkers are switched off. If the 60-dB value cannot be formed (e.g. if the signal approaches the noise level), the display "invalid shape factor" is output in the marker field (A20). The function is disabled with Zero Span.

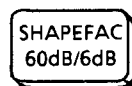

Corresponds to the function SHAPE FACTOR 60 dB/3 dB, except that the level of the first pair of markers is 6 dB smaller than that of the reference marker. The function is disabled with Zero Span.



AUTO 14

The user can be relieved of routine procedures by means of various automatic procedures:

- adjustment of RF attenuation dependent on reference level and input mixer level for full-scale deflection;
- adjustment of any signal level to the reference line of the display (AUTO RANGE);
- switching on of DC isolation at socket RF INPUT 37;
- tracking of center frequency in line with a signal of variable frequency (TRACK) and modification of the span to a preset value (ZOOM).

An automatic function, if switched on, is indicated by the corresponding LED on the front panel of the display unit.

Caution!

- In the case of AUTO RANGE, especially in mode LOW NOISE, ensure that no problems occur due to non-linearities (e.g. intermodulation products) as an erroneous measurement may otherwise be made.
- RF attenuators of at least 10 dB are always switched on to protect the input attenuator and to avoid additional frequency response. In the case of measurements at highest sensitivity (but additional frequency response as soon as the source impedance deviates from 50 Ω), the RF attenuation can be reduced below a value of 10 dB by means of an entry using RF ATTENUATION MANUAL.

Screen display:

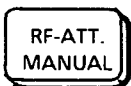
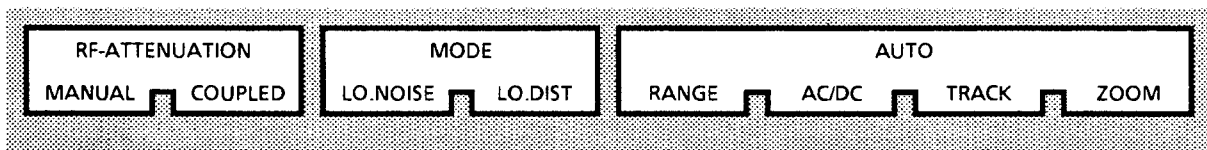

The RF attenuation can be entered via the numeric keypad, the STEP keys or the spinwheel. The attenuation value remains fixed and is not changed if the reference level is shifted.

Note:

If the RF attenuation is below 10 dB when switching off the instrument, the "RF-ATT. COUPLED" mode is automatically entered upon switching on again in order to prevent damage to the input attenuator caused by an exceeded level.

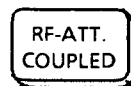

The RF attenuation is automatically changed by changing the reference level. The attenuation depends on the reference value and the operating mode selected (LOW NOISE, LOW DISTORTION, NORMAL).

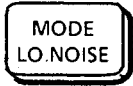

Mixer reference level -20 dBm (for full deflection). The operating mode is displayed by inverting the softkey field. Sets step size of RF attenuation to 5 dB.



A switch is automatically made to AC coupling if the start frequency is larger than the limit frequency of the AC coupling (1 MHz).



Mixer reference level -40 dBm (for full deflection). The operating mode is displayed by inverting the softkey field. Sets step size of RF attenuation to 1 dB.



This function enables automatic tracking of the analyzer center frequency with drifting signals. It corresponds to the function REF MARKER TRACK. PEAK SEARCH and MARKER TO CENTER FREQ. are carried out following each sweep. This is only possible as long as the drifting signal remains in the display range of a window on the screen or, with active threshold line, the signal level exceeds the threshold value. Otherwise, tracking is interrupted but remains active.



Switching on and off the AUTORANGE function for automatic adjustment of attenuation by determining the maximum amplitude and correction of the reference level (attenuation) following each complete sweep.

The RF ATTENUATION function is switched to COUPLED. The active AUTORANGE function is displayed by inverting the softkey field and by the LED in the AUTO field. The AUTORANGE function is switched off by pressing the softkey again.

The AUTORANGE function is automatically switched off if no stable condition is obtained after three sweeps (e.g. due to overloading or heavily varying signals).



The input of the span is activated. When the span is entered, the sweep is stopped at the marker position and the frequency measured using the built-in IF counter. Then the measured frequency, the new center frequency and the selected span are set. This function corresponds to the MARKER ZOOM function.



COUPLED FUNCTIONS 15

Selection of menu for automatic coupling and manual setting of span, resolution bandwidth, video bandwidth and sweep time.

Screen display:

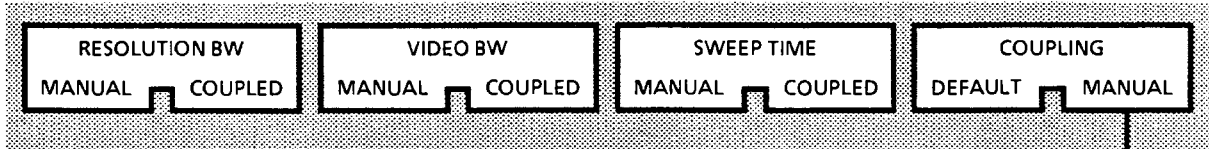

Submenu COUPLING MANUAL:

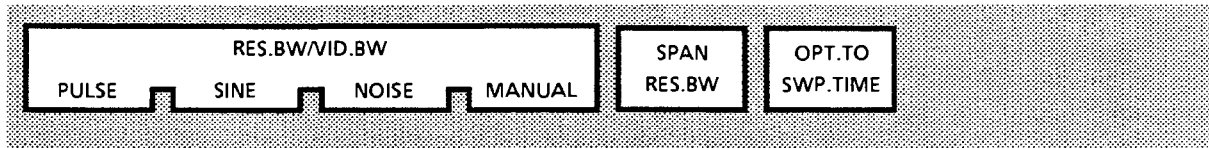

Fixed setting of resolution bandwidth with facility for changing this function value by data entry.

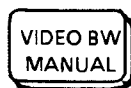

Fixed setting of video bandwidth with facility for changing this function value by data entry.



Activation of automatic coupling of resolution bandwidth to span.



Activation of automatic of video bandwidth to resolution bandwidth and span.



Fixed setting of sweep time with facility for changing this function value by data entry.



Activation of automatic coupling of sweep time to video bandwidth, resolution bandwidth and span.



Automatic coupling of resolution bandwidth, video bandwidth and sweep time to the span with the default values (cf. Fig. 2-4: Schematic display of coupling mode "COUPLING FUNCTIONS").



Selection of a submenu.

Coupling of resolution bandwidth, video bandwidth and sweep time to the span with selectable factors.

Submenu COUPLING MANUAL



In the case of pulsed signals, it is usually desired that the signal provided by the resolution filter is displayed as unmodified as possible. It is therefore necessary to make the video bandwidth significantly larger than the resolution bandwidth. This can be achieved using this function. The displayed value of the resolution bandwidth corresponds to the pulse bandwidth of the filter (approx. 6-dB value). The video bandwidth is set to a factor of 10 larger than the resolution bandwidth.

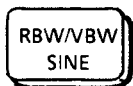

The video bandwidth is approximately the same as the resolution bandwidth. This is also the default value since this results in no considerably longer sweep time and no negative influences on discrete (sinewave) signals.

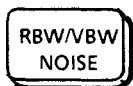

In the case of noise measurements, a video bandwidth much smaller than the resolution bandwidth is usually used to enable averaging of the displayed (video) signal. The RBW/VID:NOISE function is available for this purpose where a video bandwidth smaller by a factor of 10 is automatically used.



This function can be used to change the ratio RBW/VBW using the spinwheel **32**, the STEP keys **33, 34** or by a numeric input **31**.



This function defines the number of selection filter bandwidths per span. The value can basically be set very high, but this has the disadvantage that the sweep time is correspondingly long (increases with the square of the filter bandwidth). In SPAN LOG mode the minimum value is limited to 5.

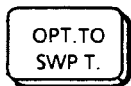

Using this function and a preset sweep time, especially when the limit values of 20 ms or 2000 s are reached, the optimum settings of the resolution and video bandwidths corresponding to the span can be automatically determined by pressing the softkey.

The change of the resolution bandwidth applies only for this setting. When this setting is changed again, the normal coupled function algorithm is applied.

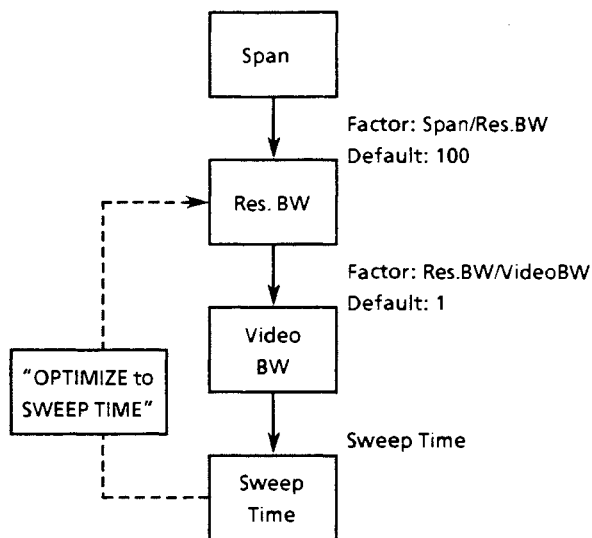
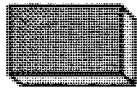

Fig. 2-4.1 Overview of coupling functions



FREQUENCY 26

This menu enables universal entry of the start frequency, stop frequency, center frequency and span. In addition to the usual combinations

center frequency with span and
start frequency with stop frequency,

all other combinations are possible using the
function FIXED, e.g.

start frequency with span or
stop frequency with span or
fixed start frequency with variable center
frequency.

The function CENTER FREQUENCY is immediately active after pressing the hardkey FREQUENCY. The softkey field CENTER FREQUENCY is colored accordingly and the command line activated for a frequency entry or variation.

Screen display:

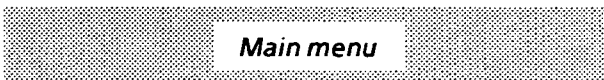
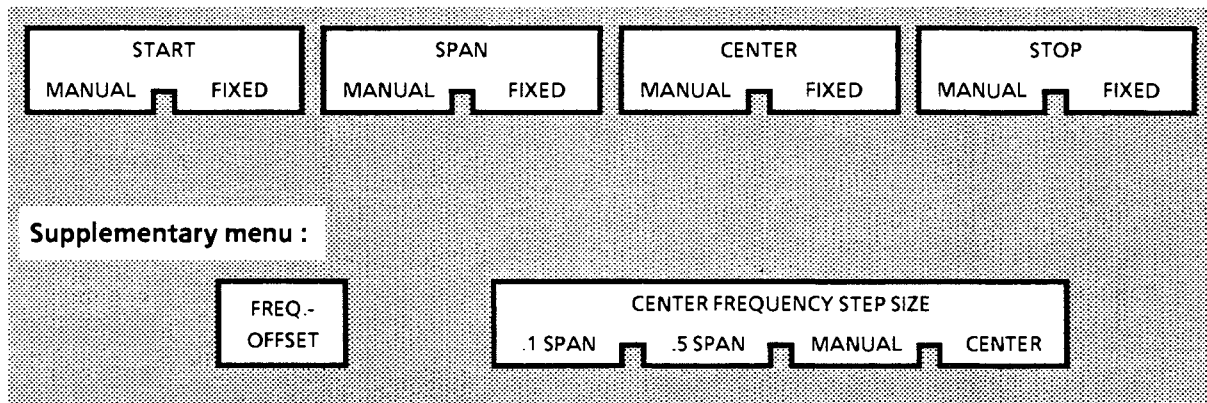

The start frequency can be changed by an entry or variation. If this key is pressed, the relationship to the stop frequency is displayed in the softkey field STOP FIXED.



The start frequency is fixed by pressing this key.



The span can be changed by an entry or variation. The relationship to the center frequency in the softkey field CENTER FIXED is displayed by pressing this key.



The span is fixed by pressing this key.



The center frequency can be changed by an entry or variation. The relationship to the span is displayed in the softkey field SPAN FIXED by pressing this key.



The center frequency is fixed by pressing this key.



The stop frequency can be changed by an entry or variation. The relationship to the start frequency is displayed in the softkey field START FIXED by pressing this key.



The stop frequency is fixed by pressing this key.

Supplementary menu FREQUENCY



Entry of a frequency offset in the command line.

The deviation of the frequency displayed on the screen from the actual frequency is indicated by the field FRQOFS in the status line (A2) on the display.



The center frequency is changed by 10 percent of the span to higher or lower frequencies by pressing the STEP keys.



The center frequency is changed to a frequency 50 percent higher or lower by pressing the STEP keys.



The center frequency is entered as a numerical value or varied step by step.
Application: measurement of signals within specific frequency limits.



The step size corresponds to the center frequency. This function is important when measuring harmonics. This key is pressed after tuning to the fundamental wave, and tuning to the harmonics takes place using the STEP key.

*Abbreviation for CENTER FREQUENCY STEP SIZE.

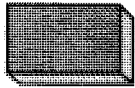

SPAN 27

Used to set the span. The display field is inverted. The current value of the span appears in the command line.

A variation is possible using the STEP keys and/or the spinwheel or by entering a number.

Screen display:



Switchover to zero span, i.e. no frequency variation is available anymore. If the input level is varied (amplitude modulation), a time/amplitude display of the input signal is obtained (similar to an oscilloscope display).



Entry of any span by means of a variation using the STEP keys 33, 34, the spinwheel 32 or by entering a number.



Sets the largest possible span.



Switchover between linear and logarithmic frequency axis. The linear frequency axis is displayed with a relative scaling (10 divisions with span/10). The logarithmic frequency axis is displayed by dividing the sweep into linear subsweeps with absolute scaling (10 or 5 divisions per decade). The decades are additionally labelled at the bottom of the grid. The linear subsweeps are formed and calculated also with changes in frequency setting prior to the first sweep. All values displayed are backed up by measuring data. This is achieved by variable oversampling. For each subsweep the respective resolution bandwidth, the video bandwidth and the sweeptime are automatically set, provided that the "COUPLED" modes are selected.

Note:

The calculation of subsweeps and the logarithmic division takes a few seconds. It is therefore recommended to enter the required instrument settings (especially frequency parameters) in SPAN LIN mode before activating the SPAN LOG mode.

For entering the SPAN LOG mode, the stop-to-start-frequency ratio must exceed 1.4.

$$\frac{f_{Stop}}{f_{Start}} > 1.4$$

In this mode, the AUTORANGE and AUTOTRACK functions are not active. The frequency parameters can only be entered via the numeric keypad. The spinwheel and the STEP keys do not work (see above note).



HOLD 35 can be used to call two different functional modes:

- switch-off of data variation
- switch-off of front panel keys and controls

Screen display:

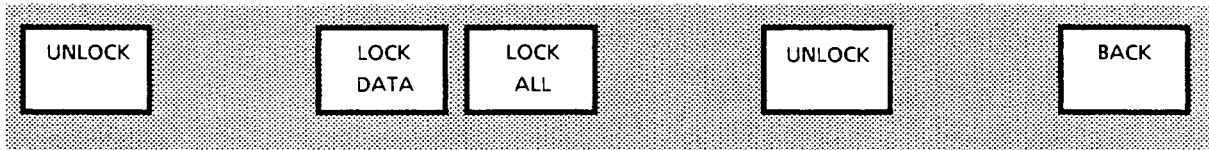

Elimination of disable of all front panel controls by pressing both functions UNLOCK.



All front panel controls, i.e. also the functions PRESET 43 and POWER ON 46 are disabled (this is important when operating in cramped conditions in a vehicle).



The LED ENABLED goes out in the function field DATA VARIATION by pressing the softkey LOCK DATA, and data variation using the spinwheel 32 or the STEP keys 33, 34 is no longer possible.



Return to the last set menu.

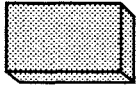

UNITS 40

A menu of units is output on the screen. The corresponding softkey field is inverted and the current unit output in field (A11) on the screen.

Screen display:

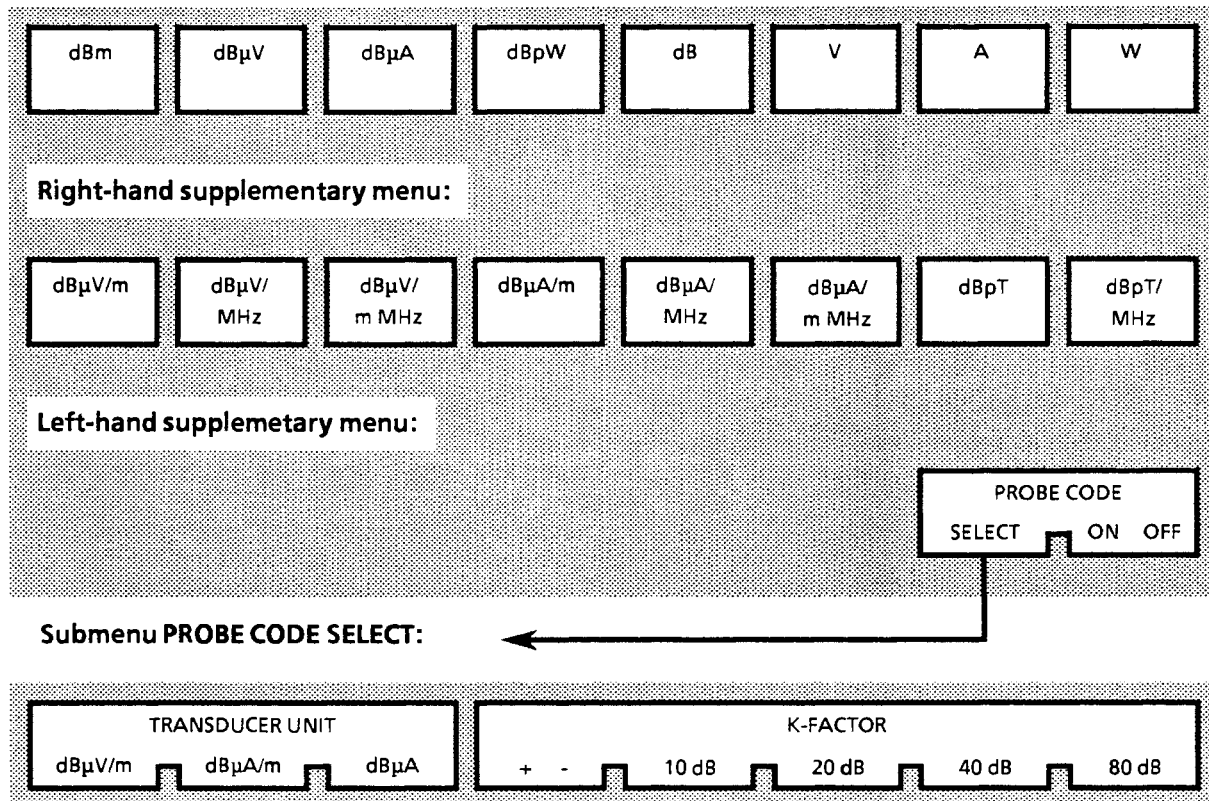

Main menu/Right-hand supplementary menu



Selection of required unit.

If the unit "dB" is selected, all displays (markers, display lines, etc.) are relative to the current reference level. The reference level is displayed in the unit selected before.

Left-hand supplementary menu



Calling a submenu for selecting a unit and K-factor of the transducer connected.

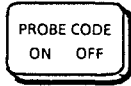

Switching on and off the coding of transducers connected to socket **39**.

Connecting a transducer (also with appropriately coded K-factor) or entering the transducer unit/K-factor in the submenu "PROBE CODE SELECT" automatically activates the "PROBE CODE ON" display. The coded unit is displayed in the unit field (A11).

The unit can be changed using the softkeys in the main menu and right-hand supplementary menu. This may lead to the conversion of all the concerned level values into the selected unit, the K- factor being retained.

If "PROBE CODE ON" without connected transducer is selected, a constant conversion factor is taken into consideration if a unit other than "dBm" is selected in the main menu or right-hand supplementary menu. The constant factor is 107 dB related to the basic unit "dBm".

When the transducer is removed or coding is switched off using "PROBE CODE OFF", automatically the unit "dBm" is selected.

Submenu **PROBE CODE SELECT**



Selecting the unit of the transducer connected.

The unit selected here (dB μ V/m, dB μ A/m, dB μ A) specifies which electrical magnitude (electric fieldstrength, magnetic fieldstrength, current) is taken up by the transducer. The alternatives offered in this case correspond to the codings possible at the socket **39**.

When connecting a transducer to the socket **39** the appropriate unit is automatically selected.

An already selected unit can be deactivated by pressing again the respective softkey.



Selecting the frequency-independent conversion factor of a transducer connected.

The alternatives offered in this case correspond to the codings possible at the socket **39**. Simultaneous activation of several level stages is allowed.

When connecting a transducer to the socket **39**, the appropriate conversion factor is automatically chosen.

An already activated level stage can be switched off by pressing again the corresponding softkey.

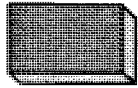

LEVEL RANGE 41

Selection of menu for the displayed level range.

Screen display:

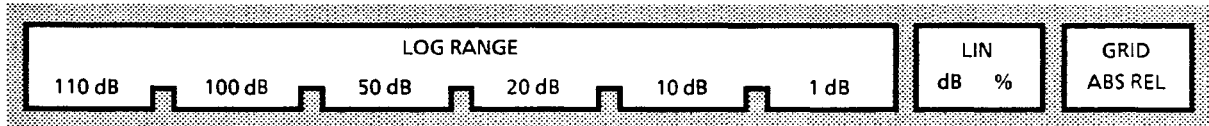

...



Selection of level range to be displayed. (The measurement of the specified range always takes place with the full resolution of the internal 12-bit A/D converter.)

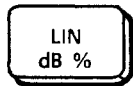

The measurement is made linearly, the scale in dB or % (toggle function).



The inscription shows absolute values or values relative to the reference level (toggle function). If the inscription is in % in the case of a linear measurement, this key has no function.

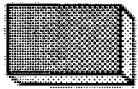

REF LEVEL 42

Selection of menu for the reference level.

Screen display:

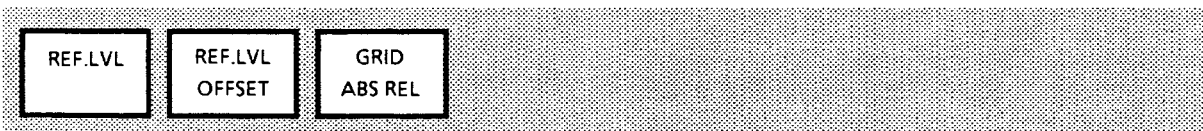

The field REFERENCE LEVEL is inverted. The command line contains e.g. REFERENCE LEVEL: -40 dBm. The reference level can be changed using the keyboard, STEP keys and spinwheel.

Caution:

If the AUTO RANGE function is active, the reference level is matched to the maximum signal following each sweep.



Entry of a mathematical offset of the reference level. The deviation of the displayed value from the physically set value is indicated by the readout of LVLOFS in the status line (A2) on the display.



The inscription shows absolute values or values relative to the reference level (toggle function). If the inscription is in % in the case of a linear measurement, this key has no function.

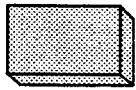

SAVE 29

Up to 9 instrument settings can be stored using SAVE and a subsequent digit. The stored setting can be additionally protected against overwriting by using SAVE ". " digit". The write protection can be eliminated for the setting using RECALL ". " (also with PRESET).

Using SAVE 1 to 4, the current TRACE memory 1 to 4 is stored together with the instrument setting. Thus, the four trace memories remain stored even after switching off the instrument.

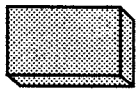

RECALL 30

The stored settings are made on the instrument using RECALL and a subsequent digit. The write protection for the stored setting is eliminated using RECALL ". ".

Using RECALL 1 to 4, the associated TRACE memory 1 to 4 is again copied into the respective TRACE. In order to avoid inadvertent overwriting, the respective TRACE memory is automatically switched to the operating mode VIEW.

The RECALL 0 function is used to obtain the basic setting of the instrument, which corresponds to the PRESET function.

However, in contrast to the PRESET function, the built-in self test is not performed.



COUPLING 36

The input can be either DC-coupled or AC-coupled using this function. The function is displayed on LEDs (AC or DC).



LOCAL 25

The keyboard functions are disabled in REMOTE mode (IEC bus remote control). The keyboard is enabled again by pressing the LOCAL key, and the instrument enters the LOCAL state.

2.3.7 RECEIVER

2.3.7.1 Theory of Operation

In the RECEIVER mode, the Spectrum Analyzer automatically operates with a frequency span set to zero, i.e. with fixed oscillator frequency.

The instrument is thus a fixed frequency receiver the receive frequency of which can be set by numeric input, by means of the STEP keys or by rotating the spinwheel in the entire frequency range. The bandwidth can be varied in the same manner in the range from 6 Hz to 3 MHz after pressing the bandwidth key.

For the RECEIVER mode in particular, the analyzer is provided with an AM IF amplifier with automatic level control (with AM over more than 60 dB), an FM IF limiter amplifier and AM or FM demodulators. The demodulated signals can be monitored via headphones. The internal loud-speaker only serves for acoustic indication.

The power output of the built-in AF amplifier is sufficient for operation of an external loud-speaker system which is not excessively loaded (with normal ambient noise level).

Unwanted noise is suppressed by a microprocessor-controlled squelch which can be set with respect to the response level.

The low-frequency signal (the demodulated IF signal) is displayed on the screen so that it can also be optically estimated and evaluated.

The demodulators are especially designed for the normal audio range <20 Hz to >20 kHz. Narrowband FM (modulation index <1 to 1) or broadband FM (modulation index up to about 50) can be used in FM operation, with AM modulation depths of <5 % up to max. 100 %.

The RECEIVER mode is largely separated from the main operating mode ANALYZER in order to enable rapid switching between these applications without the need for time-consuming new entry of parameters.

The major settings in the operating mode such as

- receive frequency
- reference level
- resolution and video bandwidth
- sweep time

can be set independently of the ANALYZER mode and are automatically set again when the operating mode is changed.

The only exception is the receiver frequency:

It is automatically changed in the ANALYZER mode when the center frequency is changed by data input or variation or when, with active marker, the position of the reference marker is changed.

The ANALYZER mode thus enables selection of a signal with a marker. The signal can be immediately demodulated and evaluated in the time domain by switching to the RECEIVER mode.

In the RECEIVER mode, the function keys are to be used as in ANALYZER mode.

The following function keys are inoperative, however (since not relevant in this mode):

- **MULTI MARKER 12**
- **SPAN 27**
- **LEVEL RANGE 41**

The COUPLED FUNCTION menu allows for manually varying the resolution bandwidth, the video bandwidth and the sweep time. The softkeys "COUPLED" and "DEFAULT" have no functions.

In addition to the short and total calibration the HELP menu allows to calibrate the frequency offset (indicating the offset of the FM demodulator) by means of the CAL AF softkey.

The softkey GRID ABS/REL is omitted in the selection of the menu for the reference level REF LEVEL.

The softkeys AUTO RANGE...AUTO ZOOM are omitted in the menu selection for the AUTO functions.

The RECEIVER menu is followed by the explanation of the function menus the meaning of which is not the same as in ANALYZER mode.

2.3.7.2 RECEIVER Menu

In contrast to the ANALYZER mode, the RECEIVER mode is provided with a main menu which is automatically displayed when changing the mode via the MODE key. This menu can also be selected from the function menus via the MENU UP key.

Screen display:

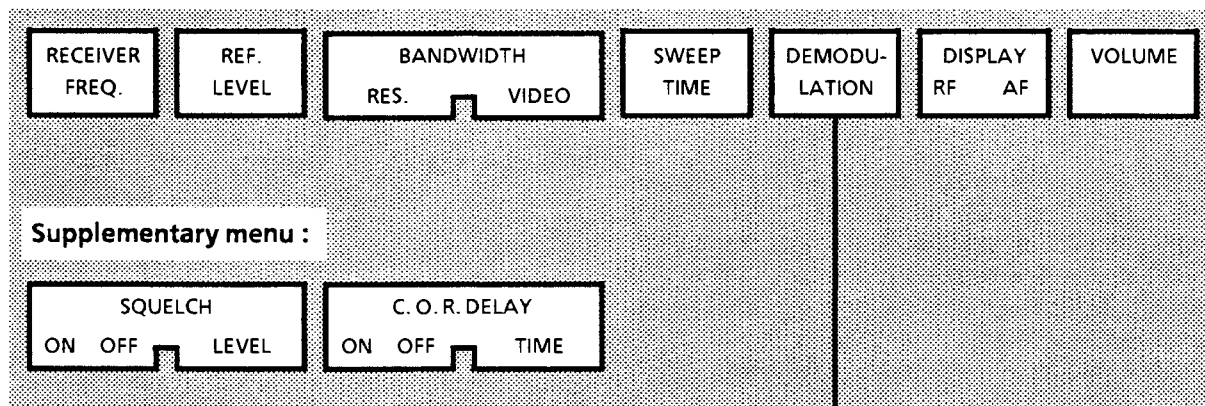

Submenu DEMODULATION:

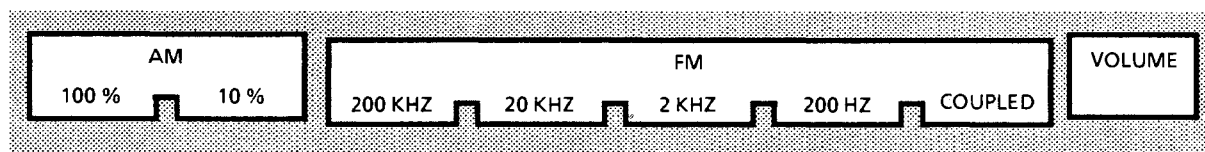

Main menu



The receiver frequency can be changed using the spinwheel, the STEP keys or by entering numbers.



The reference level is entered. The current reference level is displayed in the command line in the selected unit. The reference level can be changed by numeric input or data variation.



The resolution bandwidth is set by data input and variation.

With FM demodulation active, the associated span is simultaneously matched if the function FM COUPLED is active.



The video bandwidth is set by data input and data variation.



The sweep time can be changed by numeric input, data variation via the spinwheel or using the STEP keys.

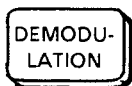

Selection of a submenu.

Switchover of AM and FM demodulator with setting of modulation depth.

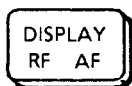

The screen display can be switched between spectrum (frequency domain) and demodulated signal (time domain) using the function DISPLAY RF/AF. For display of the spectrum, the parameters of ANALYZER mode are used, i.e. center frequency, span, reference level, sweep time and resolution bandwidths. These parameters can be selected independently in the RECEIVER mode. The display can thus be changed without the need for new entry of these values. Switching between the operating modes takes place via the MODE key.

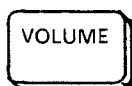

After pressing this softkey, the volume of the signal can be varied by rotating the spinwheel.

A bar display for the volume (in order to avoid problems with SQUELCH mode) is to be found in the upper part of the display on the right.

Supplementary menu RECEIVER

The SQUELCH function is switched on for suppression of unwanted noise, if the receive signal is missing or too weak. The B1 bit (pin 15) at USER PORT B (configured to output) depends on the level of the demodulated signal.

Signal level \geq squelch level: Bit B1 = 1
Signal level $<$ squelch level: Bit B1 = 0

If the signal level is below the squelch level, also a delay time can be set which has to pass before bit B1 becomes 0. However, the volume is immediately reduced in each case. USER PORT B can thus be used for control of tape recording depending on the applied signals ("Carrier Operated Relay" = C.O.R.) – provided that the port configuration corresponds to "output".



Switching on and off of the SQUELCH function for suppression of unwanted noise if the receive signal is missing or too weak.

Note:

The SQUELCH function is only active at the end of a sweep, i.e. a level variation during the sweep does not lead to immediate reaction by the SQUELCH function.



The SQUELCH threshold is selected via the threshold function by numeric input or variation using spinwheel or STEP keys.

Selection of this function leads to display of the spectrum in the frequency range, thus enabling optimum setting of the SQUELCH threshold. The demodulated signal is again displayed in the time range by pressing the softkey again or selecting another menu.

Submenu DEMODULATION

C.O.R DEL.
ON OFF

Switching on and off the delay time for control of bit B1 depending on the Squelch function.

C.O.R DEL.
TIME

Entering a delay time of 100 ms to 100 s for control of bit B1 depending on the Squelch function. The delay can be retriggered, i.e. if the signal falls below the Squelch level for less than the delay time, this does not lead to switchover of bit B1.

If a delay time is entered even though USER PORT B is configured to "input", the warning message

"Port B configured for Input"

is read out in the command line.

AM

Activation of AM demodulator with selection between 100 % and 10 % modulation depth for full deflection on the screen. The grid is labelled accordingly. The maximum modulation frequency is 20 kHz.

FM

FM
COUPLED

Activation of FM demodulator. It is possible to select a span between ± 200 kHz, ± 20 kHz, ± 2 kHz and ± 200 Hz. The selection of the span is automatically matched to the resolution bandwidth if a corresponding input is made and the function FM COUPLED is activated. The maximum modulation frequency is 20 kHz.

Explanation of the function menus whose meaning differs from that in ANALYZER mode:



DISPLAY LINE 6

The hardkey DISPLAY LINE is used to activate a menu for superimposing on the screen additional lines for measuring the signal. The status of the corresponding display line is indicated by inverted (= switched on) or colored (= active input) representation of the softkey field.

Screen display:



**DISPLAY
LINE 1 2**

Switching on and off of two horizontal display lines whose position can be changed using the spinwheel, the STEP keys or by entering numbers. The output depends on the selected type of demodulation, i.e. modulation depth in % for AM or span in kHz for FM demodulation. For switching off, the softkey must be pressed again.



**TIME
LINE 1 2**

Switching on and off of two vertical display lines whose position can be changed using the spinwheel, the STEP keys or by entering numbers. The output depends on the sweep time in μs , ms or s. For switching off, the softkey must be pressed again.

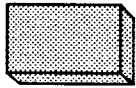

MARKER 13

This function enables use of level/time markers.

Screen display: (FM demodulation)

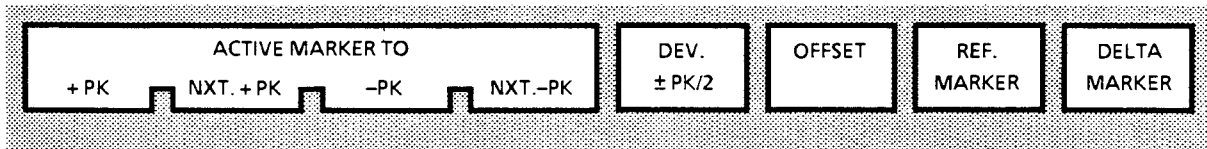

Screen display: (AM demodulation)

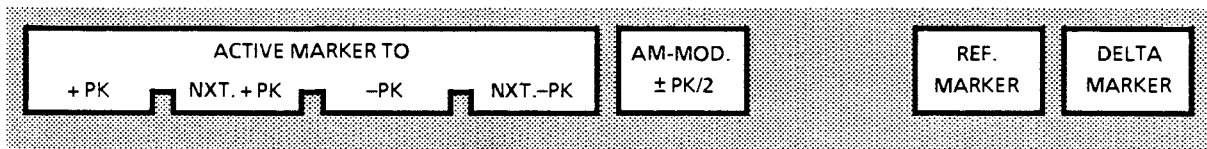

The active marker is set to the greatest signal value.



The active marker is set to the next (greater) minimum.



The active marker is set to the next (smaller) maximum.



The reference marker is set to the maximum, the delta marker to the minimum of the signal. The current FM deviation is displayed in the marker field (A20). The measurement is performed automatically following each sweep.



The active marker is set to the smallest signal value.



The reference marker is set to the maximum, the delta marker to the minimum of the signal. The average value generated from the positive and negative peak deviation measured in this way results in the offset from the signal, referred to the receiver frequency. The offset is displayed in the marker field (A20). The measurement is performed automatically following each sweep.

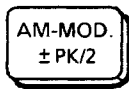

The reference marker is set to the maximum, the delta marker to the minimum of the signal. The average value of the modulation depths measured in this way is displayed as modulation depth in % in the marker field (A20). The measurement is performed automatically following each sweep.



Activation of the reference marker. The marker time can be varied by numeric entry using the STEP keys and the spinwheel. It is switched off by pressing the softkey again.



Activation of the delta marker. If the delta marker has not been switched on before, a search for the peak is performed automatically.

The time difference and the modulation depth or span difference are displayed in the marker field (A20).

For switching off, press the softkey again.

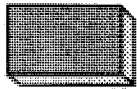

FREQUENCY 26

This menu permits to enter the receiver frequency as well as the variation step sizes.

Screen display:

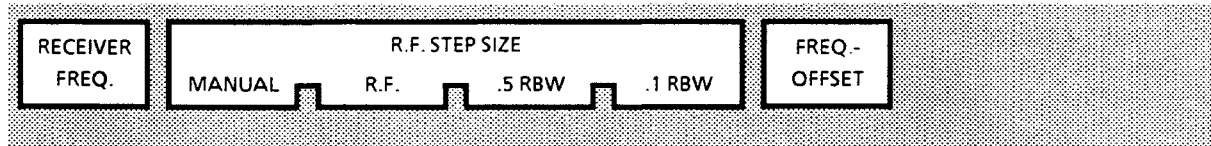

The receiver frequency can be changed by input via the numeric keypad, using the spinwheel or the STEP keys.



The step size for variation of the receiver frequency using the STEP keys corresponds to half the resolution bandwidth.



Using the STEP keys, the receiver frequency can be varied by the value entered in the step size function.



The step size for variation of the receiver frequency using the STEP keys corresponds to 1/10 of the resolution bandwidth.



This function reads in the current receiver frequency as new step size for the STEP variation.



Input of a frequency offset in the command line.

The deviation of the frequency displayed on the screen from the actual frequency is indicated by the field "FRQOFS" in the status line (A2).

2.3.8 SETUP

2.3.8.1 Theory of Operation

In the operating mode SETUP, all interfaces of the instrument can be configured for the operation:

- IEC-bus
- PARALLEL INTERFACE
- USER PORT

In addition, the builtin real-time clock with calendar can be set. All current settings are visible on the display; the entries are made interactively following selection via the softkeys. All settings are stored in a CMOS RAM with battery backup so that they are retained even when the instrument is switched off.

With the exception of HELP, all function keys are disabled in this mode.

None of the data of the SETUP menu are changed by PRESET, except for the reference which is switched to "internal" and the user ports A and B which are programmed for input mode.

2.3.8.2 SETUP Menu

Screen Display:

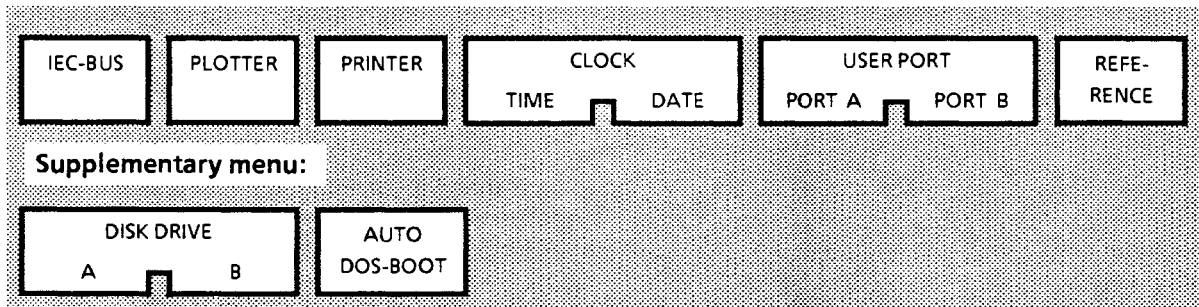

Main menu:



The IEC-bus address of the analyzer is selected by numeric input. Permissible values are the addresses 0 to 30; address 20 is factory-set.

The terminator need not be selected since, in accordance with the definition in the standard IEC-625.2, the analyzer detects "Line Feed" (LF = 0AH) and/or the END message (EOI) in Listener mode and generates both in Talker mode.



Selection of the plotter for hardcopy outputs from the analyzer display. The plotter is selected using the STEP keys, the IEC-bus address of the plotter is selected by numeric input. The following plotters are supported:

- R&S DOP
- HP GL (hp-Graphics language)

The colors can be selected via the plotter pens.

In general, the pen assignment is as follows:

Pen 1: grid, labelling, text
Pen 2: date and time, markers
Pen 3 ... Pen 6: TRACE 1 to TRACE 4



Selection of the type of printer for hardcopy outputs of the analyzer display to the printer. The printer type is selected using the STEP keys. The following printers are supported:

- R&S PDN
- R&S PDN COLOR
- R&S PUD3
- NEC P6/P7 and compatible 24-needle printers
- hp Paintjet
- hp Paintjet color
- hp Thinkjet
- hp Laserjet and compatible laser printers



Input of the time in the 24-hour format via the numeric keypad. The time is output in the hardcopy output in the command line.



Input of the date with day: month: year via the numeric keypad. The date is output in the hardcopy output in the command line.



Configuration of USER PORT A (8 data lines) as input or output port. In input mode the current bit pattern is displayed, in output mode the bit pattern to be output can be changed by numeric input after pressing the softkey again.



Configuration of USER PORT B (4 data lines) as input or output port. In input mode the current bit pattern is displayed, in output mode the bit pattern to be output can be changed by numeric input after pressing the softkey again.



Switchover between internal and external reference frequency (10 MHz) (socket 76 at rear of instrument) by means of STEP keys.

Note:
PRESET or IEC-bus command `"*RST"` switch to internal reference.
If an external reference frequency is required in IEC-bus operation, the following command for switching over must be added:
`"*RST; Reference External"`

Example: SETUP main menu

SETUP				
IEC-Busaddress 20	Printer PDN PDN COLOR PUD3 NEC P6/P7 ▶ PAINTJET PJ COLOR THINKJET LASERJET	Time 15:08:31	User-Port A ▶ Input Output 11111111	Reference 10 MHz ▶ Internal External
Plotter ▶ DOP2/HP-GL DOP 04		Date 06-04-90	User-Port B ▶ Input Output 1111	
Plotter/User-Ports:		Press Softkey again for numeric data entry!		

Supplementary menu:



Selection of disk drive type A for the Computer Function FS-K1 using the STEP keys:

- 5 1/4" with 1.2 Mbyte
- 3 1/2" with 1.44 Mbyte

Note: After changing the disk drive type with activated computer function, MS-DOS should always be rebooted (MODE menu).



Selection of disk drive type B for the Computer Function FS-K1 using the STEP keys:

- 5 1/4" with 1.2 Mbyte
- 3 1/2" with 1.44 Mbyte

Note: After changing the disk drive type with activated computer function, MS-DOS should always be rebooted (MODE menu).



When the analyzer is operated with Computer Function FS-K1, the operating system MS-DOS can automatically be loaded from the system floppy disk after switching on the instrument or on actuation of the PRESET key. The STEP keys are used for activating and deactivating this function.

Example: SETUP supplementary menu

SETUP	
Disk Drive A	
▶ 5 ¹ / ₄ " (1.2 MB)	
▶ 3 ¹ / ₂ " (1.44 MB)	
Disk Drive B	
▶ 5 ¹ / ₄ " (1.2 MB)	
▶ 3 ¹ / ₂ " (1.44 MB)	
Auto DOS-Boot	
▶ Off	
▶ On	

Warning: Reboot MS-DOS after changing disk drive type!

2.4 Remote Control of Instrument

2.4.1 IEC Bus

The analyzer is fitted with an IEC bus interface as standard. The interface corresponds to the IEC 625-1 or IEEE 488.1 standard and to IEEE 488.2 also approved of by the IEC commission. This standard describes data transfer formats and common commands etc.

The bus connection socket **61** is fitted to the rear of the display unit. The analyzer is equipped with the 24-contact socket according to the IEEE 488 standard. The interface contains three groups of bus lines:

1. Data bus with 8 lines DIO 1 to DIO 8

Data transmission is bit-parallel and byte-serial with the characters in ISO 7-bit code (ASCII code).

DIO 1 represents the least significant bit and DIO 8 the most significant bit.

2. Control bus with 5 lines

This is used to transmit control functions:

ATN (Attention)

becomes active Low when addresses, universal commands or addressed commands are transmitted to the connected devices.

REN (Remote Enable)

enables the device to be switched to the remote status.

SRQ (Service Request)

enables a connected device to send a Service Request to the controller by activating this line.

IFC (Interface Clear)

is activated by the controller in order to set the IEC interfaces of the connected devices to a defined status.

EOI (End or Identify)

can be used to identify the end of data transfer and is used with a parallel poll.

3. Handshake bus with 3 lines

Used to control the data transfer timing.

NRFD (Not Ready For Data)

an active Low on this line signals to the talker/controller that one of the connected devices is not ready to accept data.

DAV (Data Valid)

is activated by the talker/controller shortly after a new data byte has been applied to the data bus.

NDAC (Not Data Accepted)

is held at active Low by the connected device until it has accepted the data present on the data bus

Detailed information on the data transfer timing is available in the IEC 625-1 standard.

According to the IEC 625-1 standard, devices controlled via the IEC bus can be equipped with different interface functions. Table 2-2 lists the interface functions applicable to the analyzer:

Table 2-2 Interface functions

Control characters	Interface function
SH1	Source Handshake function, complete capability
AH1	Acceptor Handshake function, complete capability
L4	Listener function, complete capability, unaddress if MTA
T6	Talker function, complete capability, capability to reply to serial poll, unaddress if MLA
SR1	Service Request function, complete capability
PP1	Parallel Poll function, complete capability
RL1	Remote/Local switchover function, complete capability
DC1	Device Clear function, complete capability
DT1	Device Trigger function, complete capability
C1, C2, C3, C11	Controller function, system controller, transmits IFC, REN and interface messages. Controller function can be transferred and received.

2.4.1.1 Setting the Device Address

The device address can be set in the SETUP menu using the IEC-bus function. The address between 0 and 30 is entered using the numeric keys and remains stored when the device is switched off. The instrument is factory-set to address 20.

The address is the decimal equivalent of bits 1 to 5 of the Talker or Listener address. This form is also used with the IEC-bus command of the controller.

2.4.1.2 Local/Remote Switchover

The device is in the Local state (manual mode) when it is switched on and after the PRESET key has been pressed.

If the analyzer is addressed as a Listener by a controller (using the BASIC commands IECOUT or IECLAD in the case of R&S controllers), it enters the Remote state in line with the standard and remains in this state after data transfer has been completed. This is indicated by the REMOTE LED. All controls on the front panel except the LOCAL, PRESET and ON keys are disabled.

There are two methods to return to the Local state:

- by the addressed command GTL (Go to Local) from the controller.
- by pressing the LOCAL key. Data output from the controller to the analyzer should be stopped before pressing the LOCAL key for otherwise the analyzer will immediately enter the Remote state again. The function of the LOCAL key can be disabled by the controller by sending the universal command LLO (Local Lockout).

The other device settings are not changed when switching from Remote to Local state or vice versa.

The softkey menus are not indicated in the Remote state, since proper operation is not possible.

When the analyzer is switched to the Local state, the respective main menu of the current operating mode or, in ANALYZER mode, the Frequency menu is indicated.

2.4.1.3 Interface Messages

Interface messages (according to IEC 625-1/IEEE 488 standard) are transmitted to the device on the data lines where the Attention line ATN is active (Low).

2.4.1.3.1 Universal Commands

The universal commands have codes between 10 and 1F hexadecimal (see Table 2-5). They act, without previous addressing, on all devices connected to the bus.

2.4.1.3.2 Addressed Commands

The addressed commands have codes between 00 and 0F hexadecimal (see Table 2-5). They only act on devices addressed as Listeners (by the BASIC command "IECLAD addr").

Table 2-3 Universal commands

Command	Basic command with R&S controllers	Function
DCL (Device Clear)	IECDCL	Aborts processing of the currently received commands and sets the command processing software to a defined initial status. The device setting is not changed.
LLO (Local Lockout)	IECLLO	The LOCAL key is disabled.
SPE (Serial Poll Enable)	IECSPE *	Ready for serial poll.
SPD (Serial Poll Disable)	IECSPD *	End of serial poll.

Table 2-4 Addressed commands

Command	Basic command with R&S controllers	Function
SDC (Selected Device Clear)	IECSDC	Aborts processing of the currently received commands and sets the command processing software to a defined initial status. The device setting is not changed.
GTL (Go To Local)	IECGTL	Change to Local state (manual operation)
GET (Group Execute Trigger)	IECGET	Starts a sweep

* The BASIC command "IECSPL adr, status" contains the commands "IECSPE" and "IECSPD" and additionally reads the status of the device with address "adr" and stores this in the integer variable "status".

Table 2-5 ASCII/ISO and IEC-character set

Control characters					Numbers and special characters				Upper-case letters				Lower-case letters				
0	NUL		16	DLE		32	SP	48	0	64	@	80	P	96	`	112	p
1	SOH	GTL	17	DC1	LLO	33	!	49	1	65	A	81	Q	97	a	113	q
2	STX		18	DC2		34	"	50	2	66	B	82	R	98	b	114	r
3	ETX		19	DC3		35	#	51	3	67	C	83	S	99	c	115	s
4	EOT	SDC	20	DC4	DCL	36	\$	52	4	68	D	84	T	100	d	116	t
5	ENQ	PPC	21	NAK	PPU	37	%	53	5	69	E	85	U	101	e	117	u
6	ACK		22	SYN		38	&	54	6	70	F	86	V	102	f	118	v
7	BEL		23	ETB		39	'	55	7	71	G	87	W	103	g	119	w
8	BS	GET	24	CAN	SPE	40	(56	8	72	H	88	X	104	h	120	x
9	HT	TCT	25	EM	SPD	41)	57	9	73	I	89	Y	105	i	121	y
10	LF		26	SUB		42	*	58	:	74	J	90	Z	106	j	122	z
11	VT		27	ESC		43	+	59	;	75	K	91	[107	k	123	{
12	FF		28	FS		44	,	60	<	76	L	92	\	108	l	124	
13	CR		29	GS		45	-	61	=	77	M	93]	109	m	125	}
14	SO		30	RS		46	.	62	>	78	N	94	^	110	n	126	~
15	SI		31	US		47	/	63	? / UNL	79	O	95	-	111	o	127	DEL
Addressed commands			Universal commands		Listener addresses				Talker addresses				Secondary addresses and commands				

Code:

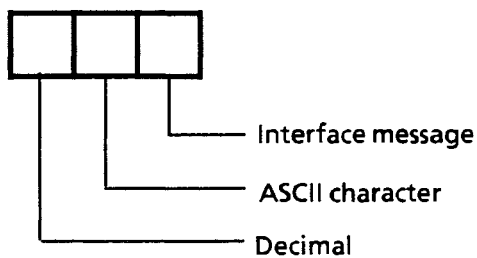

2.4.1.4 Device Messages

Device messages (to IEC 625-1) are transmitted on the data lines, in which case the Attention line is High, i.e. not active. The ASCII code (ISO 7-bit code) is used (see Table 2-5).

As can be seen in Table 2-6, the device messages can be grouped according to two different aspects.

Tabelle 2-6 Device messages

Type of commands	Direction of transfer	
	Messages received by the analyzer	Messages sent by the analyzer
Device independent (common) commands (in line with the IEEE 488.2 standard)	see Table 2-7	see Table 2-8
Device-specific commands (dependent on device characteristics)	see Table 2-9	see Table 2-9

In the following text, device messages received by the analyzer are referred to as commands.

Commands with a "?", such as "FREQUENCY: CENTER?" request the analyzer to output a set value where the same format is used as in the command table. For the given example, this is:

"FREQUENCY: CENTER 123.45678E + 6",

where the basic unit always applies (Hz in this case).

2.4.1.4.1 Commands Received by the Analyzer in Listener Mode (Controller to Device Messages)

Input buffer:

All commands received are buffered in a memory of max. 2560 bytes; it is also possible to process command lines which are longer. In this case, the part of the command line which was first received is already processed in the device.

Command syntax:

Fig. 2-5 shows the syntax of a command line (program message). Every command line must end with a terminator.

Terminators:

- New line (ASCII code 10 decimal)
- End (EOI line active) together with the last useful character of the command line or the new line character.

Since the carriage return character (ASCII code 13 decimal) is permissible as a filler without effect before the terminator, the combination of carriage return + new line is permissible.

All IEC-bus controllers from Rohde & Schwarz send terminators accepted by the device as standard. A command line may require more than one line on the controller screen since it is only limited by the terminator. The terminator is automatically added to the end of command text with most IEC-bus controllers.

Separators:

A command line may contain several commands (program message units) separated by semi-colons (;).

Command structure:

A command may consist of the following parts:

- Only a header
Example: *RST
- Header and question mark (Query)
Example: F:C?

This combination requests the analyzer to transfer the desired data to an output buffer in order to transfer them via the IEC bus as soon as it is addressed as a Talker (see Section 2.4.1.4.2).

- Header and number

Examples: *F:C 123.5E6*
F:C 123.5MHZ

To remain in accordance with the IEEE 488.2 standard, the header and number(s) must be separated by at least one space (ASCII code 32 decimal). In the case of device-specific commands, the number can be supplemented by a unit.

- Header and string

Example: *SPAN FULL*

The headers and their meanings are explained in Sections 2.4.1.4.3 and 2.4.1.4.4.

Lower case/upper case letters:

Lower case letters are permissible and are equivalent to the corresponding upper case letters. Thus units can be used in the usual form (e.g.: dBm) instead of the notation using upper case letters which is also permissible (e.g. DBM).

Spaces:

Additional spaces may be inserted at the following points:

- before a header;
- between header and number;
- before and after commas (,) and semicolons (;)
- before the terminator.

Numeric values:

Only decimal values are allowed as numeric values, the following notations are permissible:

- With and without sign
e.g. 5, +5, -5
- With and without decimal point, any position of decimal point is permissible.
e.g. 1.234, -100.5, .327

- With or without exponent to base 10, "E" or "e" is used as the exponent character.
e.g. .451, 451E-3, +4.51e-2
- The exponent is permissible with or without a sign, also a space is permissible instead of the sign.
e.g. 1.5E +3, 1.5E-3, 1.5E 3
- Leading zeros are permissible in the mantissa and exponent.
e.g. +0001.5, -01.5E-03
- The length of the number, including the exponent, may be up to 20 characters. The number of digits for the mantissa and exponent is only limited by this condition. Digits which exceed the resolution of the device are rounded up or down; they are always considered for the order of magnitude (power of ten).
e.g. 150000000, 0.00000032

Note: Specification of the exponent alone (e.g.: E-3) is not permissible, 1E-3 is correct).

Command line

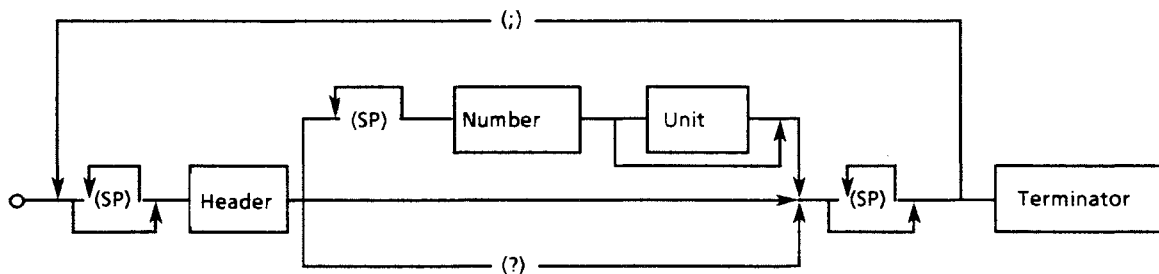

Zahlenwert

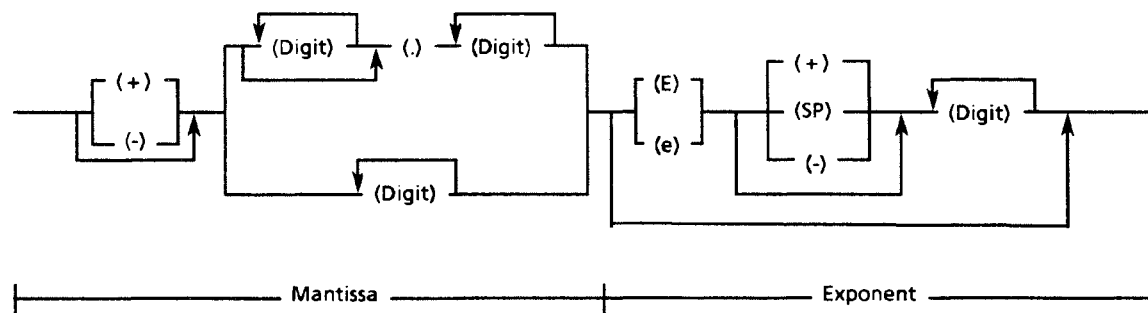

SP: Any character with ASCII code 0 to 9 and 11 to 32 decimal, especially space.

Fig. 2-5 Syntax diagram of a command line

2.4.1.4.2 Messages Sent by the Analyzer in Talker Mode (Device to Controller Messages)

The device sends messages via the IEC bus if it

- has been requested to provide data in its output buffer by one or more query messages with a question mark within one command line,
- indicates by setting bit 4 (message available) in the status byte that the requested data are now present in the output buffer (see also Section 2.4.1.5), and
- has been addressed as a talker (BASIC command "IECIN adr, string variable").

Note that the command line with the data request must be transmitted directly before the talker is addressed. If another command line is present in between, the output buffer is cleared. The maximum length of the output buffer is 2560 bytes.

A query message is formed by adding a question mark "?" onto the header of Table 2-9, e.g. "SPAN?".

If the device is addressed as a Talker directly after the query message, the bus handshake is disabled until the requested data are available. This simple synchronization procedure is certainly meaningful with the analyzer if the execution of a query message can take place independent of the execution and termination of a sweep.

The syntax of the messages sent by the analyzer is shown in Fig. 2-6. The syntax is similar to that for commands received by the FSA.

A new line (ASCII code 10 decimal) together with end (line EOI active) is used as terminator.

The transmission of "header and numbers" makes it possible that the messages sent by the analyzer can again be returned to the analyzer in the same form, without any amendments as setting commands. Thus a setting made on the keyboard can be read, stored in the controller and repeated later via the IEC bus.

- If the analyzer receives several query messages, it also returns several messages within one line separated by semicolons (;).
- Several numbers can be sent as a reply to certain query messages (e.g. MARKER?), they are separated by commas (,).
- Header and numbers are always separated by spaces.
- Headers only consist of upper-case letters and the characters ":", "___" and "*".
- The syntax of the numbers is described in Fig. 2-6. The exact form of the numbers of each message is described in Tables 2-8 and 2-9.
- Messages sent by the analyzer do not contain units. In the case of physical variables, the numbers are referred to the basic unit specified in Table 2-9.

Output message line

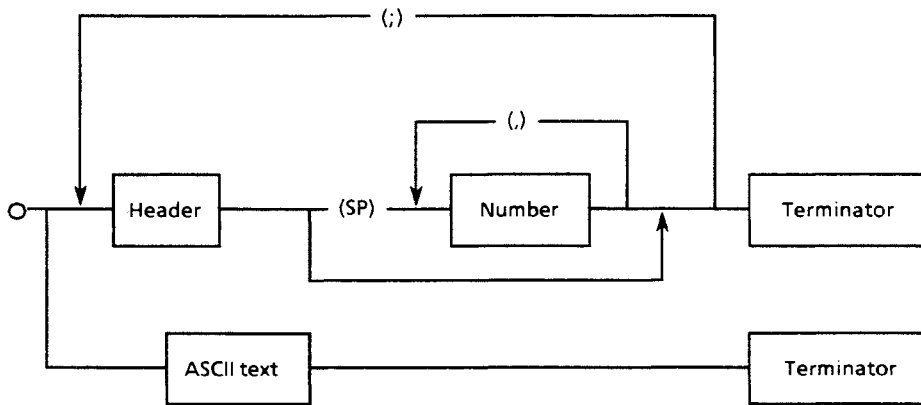

Number

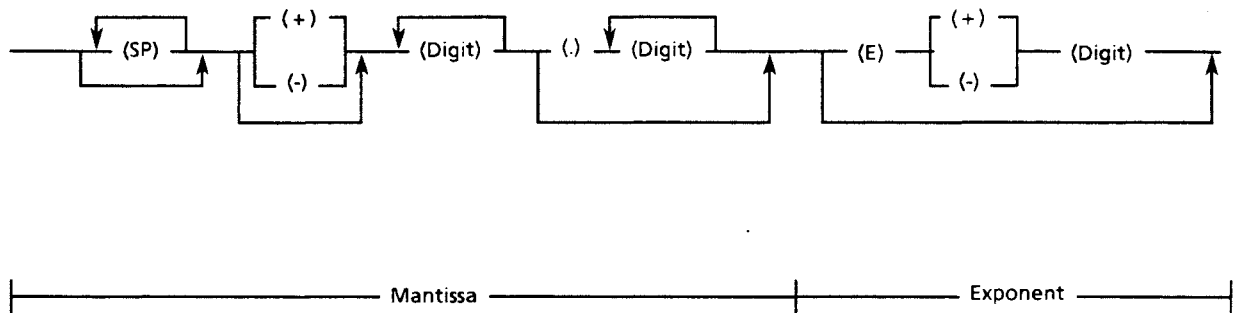

SP: Space (ASCII code 32 decimal)
 ASCII text: Reply to command *IDN? (see Table 2-8)

Fig. 2-6 Syntax diagram of messages sent by the analyzer

2.4.1.4.3 Device-independent Commands (Common Commands)

These commands are listed in Tables 2-7 and 2-8 and can be split up into the following groups:

- Commands which refer to the Service Request function with the associated status and mask registers
- Commands for device identification
- Commands which refer to the Parallel Poll function
- Commands for triggering sequences

- Commands for device-internal sequences (reset, calibrate) and for synchronizing sequences.

These are taken from the IEEE 488.2 standard, which ensures that these commands have the same effect in different devices.

The headers of these commands consist of a star (*) followed by three letters.

Table 2-7 Device-independent commands (common commands) received by the analyzer

Command	Number, range	Meaning
*RST	---	<p>Reset</p> <p>Acts on the instrument setting like the PRESET key, however without automatic self-test.</p> <p>This command does not change the status of the IEC-bus interface, the set IEC-bus address, the mask register of the Service Request function and the output buffer.</p> <p>A current Service Request is only reset if it has not been produced by a message in the output buffer.</p>
*PSC	0 to 65535	<p>Power On Status Clear (reset on power-up)</p> <p>If >0: with power-up, the Service Request Enable mask register (SRE) and the Event Status Enable mask register (ESE) are cleared in addition.</p> <p>If 0: the above-mentioned registers retain their contents when the device is switched on and off. This enables a Service Request when the device is switched on.</p>
*OPC	---	<p>Operation Complete (ready signal)</p> <p>Sets bit 0 (Operation Complete) in the ESR, if all previous commands have been processed (see Section 2.4.1.7).</p>
*CLS	---	<p>Clear Status</p> <ul style="list-style-type: none"> ● Sets the status registers (ESR and STB) to zero. The mask registers of the Service Request function (ESE and SRE) are not changed. ● Clears the output buffer. <p>A present Service Request is cleared (see Section 2.4.1.5).</p>
*ESE	0 to 255	<p>Event Status Enable</p> <p>The ESE mask register is set to the specified value which is interpreted as a decimal number (see Section 2.4.1.5).</p>
*SRE	0 to 255	<p>Service Request Enable</p> <p>The SRE mask register is set to the specified value which is interpreted as a decimal number (see Section 2.4.1.5).</p>

Command	Number, range	Meaning
*PRE	0 to 65535	Parallel Poll Enable The Parallel Poll Enable mask register is set to the specified value which is interpreted as a decimal number (see Section 2.4.1.5).
*PCB	0 to 30	Pass Control Back Specify the address of the controller to which the bus control is to be returned after completion of the plotter output.
*TRG	---	Trigger Starts a sweep. Same function as GET message.
*RCL	1 to 9	Recall Recall a stored device setting. Same function as RECALL key 30.
*SAV	1 to 9	Save Save a current device setting. Same function as SAVE key 29.
*WAI	---	Wait To Continue Only process the subsequent commands when all previous commands have been completely executed (see Section 2.4.1.7).

Table 2-8 Device-independent commands sent by the analyzer

Command	Output message Data value		Meaning
	No. of digits	Range	
*IDN?	23	Alpha-numeric	<p>Identification Query</p> <p>The following identification text is sent via the IEC bus as a reply to the IDN? command (always without header).</p> <p>Example: ROHDE&SCHWARZ, FSA,0,1.00 1.00 1.00</p> <p>ROHDE&SCHWARZ = Manufacturer FSA = model 0 = reserved for serial number (not used with the analyzer) 1.0 1.00 1.00 = firmware version (for example)</p>
*PSC?	1	0 or 1	<p>Power On Status Clear Query</p> <p>To read the status of the Power On Clear flag, see *PSC in Table 2-7</p>
*OPC?	1	1	<p>Operation Complete Query (ready message)</p> <p>The message "*OPC1" is entered into the output buffer and bit 4 (message available) set in the status byte if all previous commands have been completely executed. Bit 0 (operation complete) is also set in the ESR (see Section 2.4.1.7).</p>
*ESR?	1 to 3	0 to 255	<p>Event Status Register Query</p> <p>The contents of the ESR are output in decimal form and the register then set to zero.</p>
*ESE?	1 to 3	0 to 255	<p>Event Status Enable Query</p> <p>The contents of the ESE mask register are output in decimal form.</p>
*STB?	1 to 3	0 to 255	<p>Status Byte Query</p> <p>The contents of the status byte are output in decimal form.</p>
*CAL?	1	0 or 1	<p>Calibration Query</p> <p>A short calibration is triggered. The reply 0 is output if the calibration is terminated properly, otherwise reply 1.</p>

Command	Output message Data value		Meaning
	No. of digits	Range	
*SRE?	1 to 3	0 to 255	Service Request Enable Query The contents of the SRE mask register are output in decimal form.
*TST?	1 to 3	0 to 255	Self-Test Query Execution of device self-test routine. An output value "0" indicates that the self-test has been terminated correctly.
*IST?	1	0 or 1	To read the current device status (see Section 2.4.1.5)
*PRE?	1 to 3	0 to 255	The contents of the Parallel Poll Enable register are output in decimal form.

2.4.1.4.4 Device-specific Commands

All analyzer functions which can be set using the keyboard can also be controlled via the IEC bus. The effect of the setting commands is the same as the corresponding entry via the keyboard.

According to the output in the display, the values of all setting parameters can also be read out via the IEC bus, especially the marker frequency and marker level values.

Table 2-9 shows the setting commands and the data request commands with the associated messages sent by the analyzer.

The headers are the same as the key designations or similar to them. This results in easy-to-read (self-documenting) programs.

The headers can be abbreviated by omitting any characters at the end (e.g. LEV instead of LEVEL). The shortest possible notation is shown in Table 2-9 in **bold print**.

Many headers consist of several parts separated by colons (:), e.g. "FREQUENCY:START". The abbreviations can be used in each part of the header (e.g.: "F:STA").

Certain headers contain the underline character (ASCII code 95 decimal) to facilitate reading.

All setting commands which must be assigned values are listed in Table 2-9 in the column "Data". Certain commands may also have a character string as the data, e.g. "SPAN FULL" for a frequency span across the complete frequency range of the analyzer, or "SPAN ZERO" for receiver mode.

A unit can be added directly to the numbers in the setting commands (e.g.: 125.3 MHz, or also 125.3E3 kHz). The permissible units are listed in Table 2-9. They may also be abbreviated and written with lower-case or upper-case letters. If no unit is used, the respective default unit applies (Hz, dBm, dBV, %, dB, see Table 2-9).

Table 2-9 Device-specific setting commands

Command	Data	Units	Meaning
ATTENUATION ATTENUATION?	0 ... max. INCREMENT DECREMENT COUPLED	DB -- -- --	Preamplification Increment Decrement Coupling on
AUTO:RANGE :AC_DC	ON OFF ON OFF	-- -- -- --	Auto range on Auto range off Automatic input coupling AC on off
BANDWIDTH:RESOLUTION :RESOLUTION? :VIDEO :VIDEO?	6 Hz to 3 MHz INCREMENT DECREMENT COUPLED FIXED 1Hz, 3 Hz, 10 Hz, to 3 MHz INCREMENT DECREMENT COUPLED FIXED	HZ (default) KHZ MHZ GHZ -- -- -- -- HZ (default) KHZ MHZ GHZ -- -- -- --	Resolution bandwidth Increment Decrement Automatic coupling on Automatic coupling off Video bandwidth Increment Decrement Automatic coupling on Automatic coupling off
CALIBRATION:SHORT :TOTAL :AF	-- -- --	-- -- --	Short calibration Total calibration Calibration AF unit
CAL_CORRECTION	ON OFF	-- --	Incorporation of cal correction values
CAL_DATA?	--	--	Binary readout of calibration data

Command	Data	Units	Meaning
COUPLING:DEFAULT	--	--	Automatic coupling of resolution bandwidth, video bandwidth and sweep time to span
:RES_VIDEO :RES_VIDEO?	0,01...100	--	Coupling factor Res./video bandwidth
	INCREMENT DECREMENT	-- --	Increment Decrement
	SINE PULSE NOISE	-- -- --	Factor = 1 Factor = 0,1 Factor = 10
:SPAN_RES :SPAN_RES?	1...9999	--	Coupling factor Span/res. bandwidth
	INCREMENT DECREMENT	-- --	Increment Decrement
:INPUT	AC DC	-- --	Input coupling AC Input coupling DC
DATE DATE?	dd, mm, yy	--	Date (day, month, year)
DELTAMARKER DELTAMARKER:FREQUENCY	Start frequency ... Stop frequency	HZ KHZ MHZ GHZ	Change delta marker frequency (only with span > 0 Hz) (absolute frequency)
DELTAMARKER DELTAMARKER:TIME	0...Sweep time	S MS US NS	Change delta marker time (only with span >0Hz) (absolute time)
	INCREMENT DECREMENT	-- --	Increment Decrement
	ON OFF	-- --	Delta marker on Delta marker off
DELTAMARKER?	--	--	Output of delta marker frequency and level (span > 0 Hz) or time and level (span = 0 Hz) (relative to ref. marker)
DELTAMARKER:FREQUENCY?	--	--	Output of delta marker frequency (span >0 Hz)
:TIME?	--	--	Output of delta marker time (span = 0 Hz)
:BIT?	--	--	Output of delta marker bit (span = 0 Hz)

Command	Data	Units	Meaning
DELTAMARKER:LEVEL?	--	--	Output of delta marker level
DELTAMARKER:PEAK	--	--	Peak-Search
:NEXT_PEAK	--	--	Next Peak Search
:MIN	--	--	Minimum Search
:NEXT_MIN	--	--	Next Min Search
:PHASE_NOISE	ON OFF	-- --	Phase noise marker on Phase noise marker off
:COUNT	ON OFF	-- --	Frequency counter switched on
:N_DB_DOWN	0to150 dB ON OFF	DB	N-DB-DOWN marker on off
:CENTER	--	--	DELTA MARKER value becomes
:START	--	--	- center frequency
:STOP	--	--	- start frequency
:REFERENCE	--	--	- stop frequency
:CF_STEP	--	--	- reference level
:SPAN	--	--	Step size of center frequency = delta marker frequency
:NEXT_MULTI	--	--	Span = delta marker frequency
:PREVIOUS_MULTI	--	--	Delta marker to next multimarker
:SHAPE_FACTOR:F_60DB_3DB?	--	--	Delta marker to previous multimarker
:F_60DB_6DB?	--	--	Shape factor 60 dB/3 dB Shape factor 60 dB/6 dB
DETECTOR	COUPLED AUTOPEAK POS_PEAK NEG_PEAK SAMPLE	-- -- -- -- --	Detector mode - coupled - normal - positive peak - negative peak - sample
DISPLAY:LINE1 :LINE1?	(Ref. Level- Level Range) ... Ref. Level INCREMENT DECREMENT ON OFF	DBM -- -- -- --	Display line 1 Increment Decrement on off
:LINE2 :LINE2?	"	"	Display line 2

Command	Data	Units	Meaning
DISPLAY:SPLIT	ON OFF	-- --	Split screen on off
:WINDOW :WINDOW?	1 to 2 --	-- --	Selecting the active window
ERRORS?	--	--	Output of error number 0 no error 20 parser fatal error 21 misplaced token 22 incorrect syntax 23 illegal command 24 ambiguous command 25 illegal character data 26 ambiguous character data 27 numeric data out of range 28 illegal suffix 29 ambiguous suffix 30 *OPC failed 31 Marker not active 32 Deltamarker not active 33 Multimarker not active 34 output queue over- flow; some output data lost 35 previous output not read by controller or attempt to read out- put data from emp- ty output queue 36 Invalid Block Data; Transmission aborted 37 Normalize transmission/ reflection aborted 38 Response calibration aborted 39 Line not active 40 Invalid Shape factor 41 Table not active 42 All traces blank or view 44 No text available

Command	Data	Units	Meaning
ERRORS:REPORT?	n, Code1,...Code n	--	Output of error codes in the error report <u>Error messages RF Unit:</u> 1 YTO unlocked 2 IF overrange 3 Level 1st LO 4 Level 2nd LO 5 Level 2nd IF 6 Level TG 2 7 Power supply 11 Temperature 12 Fan 13 Power supply 15 Frequency TG 2 16 Level TG 1 17 10 MHz reference osc. 18 100 MHz reference osc. 20 Frequency summing osc. 21 Frequency step osc. 22 Frequency M osc. 23 Frequency N osc. 24 Frequency sweep osc. 27 Frequency 2nd local osc. 29 RF overrange 30 YIG fine tuning error 31 Oven cold <u>Error messages Display-Unit:</u> 40 Power supply 41 Temperature 42 Fan 43 Power supply 47 Level step gain 48 Analyzer bus 49 Analyzer bus
ERA?	--	--	Output event status register A
ERAE ERAE?	0 to 65535	--	Enable register for event status register A

Command	Data	Units	Meaning
ERB?	--	--	Output event status register B
ERBE ERBE?	0 to 65535	--	Enable register for event status register B
FREQUENCY:CENTER :CENTER?	0 to max.	HZ (Default) KHZ MHZ GHZ	Center frequency
INCREMENT DECREMENT		-- --	Increment Decrement
COUPLED FIXED		-- --	Frequency coupling on Frequency coupling off
:START :START?	"	"	Start frequency
:STOP :STOP?	"	"	Stop frequency
:OFFSET :OFFSET?	-500 to + 500 GHz INCREMENT DECREMENT	"	Frequency offset
:CENTER:STEPSIZE :STEPSIZE?	0 to max. INCREMENT DECREMENT	"	Step size of center frequency
FREQUENCY:LINE1 :LINE1?	Start frequency... Stop frequency	HZ KHZ MHZ GHZ	Frequency line 1
INCREMENT DECREMENT		-- --	Increment Decrement
ON OFF		-- --	on off
:LINE2 :LINE2?	"	"	Frequency line 2
GRID	ON OFF	-- --	Grid scaling on Grid scaling off
INPUT:IMPEDANCE	50 Ω	OHM KOHM MOHM	Input impedance 50 Ω
:RAM :RAZ	75 Ω "	" "	Input impedance 75 Ω (RAM measurement) 75 Ω (RAZ measurement)

Command	Data	Units	Meaning
LEVEL:MIXER :MIXER? :RANGE :RANGE? :REFERENCE :REFERENCE? :REFERENCE:OFFSET :REFERENCE:OFFSET?	-10 to -140 dBm INCREMENT DECREMENT NORMAL LOW_NOISE LOW_DISTORTION COUPLED	DBM -- -- -- -- --	Mixer level Increment Decrement normal low noise low distortion coupled
	110 dB 100 dB 50 dB 20 dB 10 dB 1 dB	DB	Display range level
	-130 to + 30 dBm INCREMENT DECREMENT	DBM -- --	Reference level Increment Decrement
	-116 to + 120 dB INCREMENT DECREMENT	DB -- --	Reference level offset
LIMIT:LINE1 : : : :LINE8 :LINE1? : : : :LINE8?	n, freq, lvl (, freq, lvl ...) or n, time, lvl (, time, lvl ...) ON OFF CLEAR COPY,line_nr SHIFT,freq,lvl	-- (n) HZ (freq) KHZ MHZ GHZ S (time) MS US NS DBM (lvl)	Entering the sample points of the limit lines n: Number of sample points(max. 16) freq: Frequency of sample point time: Time of sample point (span = 0) lvl: Level of sample point Switching on and off of limit line Copy to line_nr Shift by freq: frequ. difference lvl: level difference
LIMIT-CHECK:LINE1 : : : :LINE8	ON OFF UPPER LOWER TRACE,trc_nr	-- -- -- -- --	Limit-Check on off Check upper limit lower limit Selection of trace to be tested

Command	Data	Units	Meaning
LINestyle:GRID	SOLID DASHED DOTTED DASHED.DOTTED	-- -- -- --	Grid line style Solid Dashed Dotted Dashed-dotted
LINestyle:DISPLAY:LINE1	"	"	Display line style 1
:LINE2	"	"	Display line style 2
:FREQUENCY:LINE1	"	"	Frequency line style 1
:LINE2	"	"	Frequency line style 2
LOGO	ON OFF	-- --	Logo of company on Logo of company off
MARKER MARKER:FREQUENCY	Start frequency ... Stop frequency	HZ KHZ MHZ GHZ	Change marker frequency (only with span >0 Hz)
MARKER MARKER:TIME	0...sweep time	S MS US NS	Change marker time (only with span = 0 Hz)
	INCREMENT DECREMENT	-- --	Increment Decrement
	ON OFF	-- --	Marker on Marker off
MARKER?	--	--	Output of marker frequency and level (span >0 Hz) or time and level (span = 0 Hz)
MARKER:FREQUENCY?	--	--	Output marker frequency (span >0 Hz)
:TIME?	--	--	Output marker time (span = 0 Hz)
:LEVEL?	--	--	Output marker level
:FORM	TRIANGLE CIRCLE CROSS X.CROSS	-- -- -- --	Change marker form Triangle Circle Cross (vertical) Cross (diagonal)

Command	Data	Units	Meaning
MARKER:PEAK	--	--	Peak Search
:NEXT_PEAK	--	--	Next Peak Search
:MIN	--	--	Minimum Search
:NEXT_MIN	--	--	Next Min Search
:NOISE	ON OFF	-- --	Noise marker on Noise marker off
:COUNT	"	--	Frequency counter switched on
:FIXED	"	--	"Freeze" marker
:TRACK	"	--	Signal track on/off
:ZOOM	0 to max.	HZ KHZ MHZ GHZ	Signal zoom
:CENTER	--	--	Marker to
:START	--	--	- center frequency
:STOP	--	--	- start frequency
:REFERENCE	--	--	- stop frequency - reference level
:CF_STEP	--	--	Step size of center frequency = marker frequency
:NEXT_MULTIMARKER	--	--	Marker to next multimarker
:PREVIOUS_MULTIMARKER	--	--	Marker to previous multimarker
MODE	ANALYZER RECEIVER SETUP	-- -- --	Operating mode Analyzer Receiver Setup
MONITOR	ON OFF	-- --	Monitor on Monitor off

Command	Data	Units	Meaning
MULTIMARKER	Start frequency ... Stop frequency	HZ KHZ MHZ GHZ	Set multimarker
MULTIMARKER?	--	--	Output of number, frequency and level of all active multimarkers
MULTIMARKER:FREQUENCY?	--	--	Output of all multimarker frequencies
:LEVEL?	--	--	Output of all multimarker levels
:PEAK	--	--	Peak Search
:SET	--	--	Set multimarker to marker position
:CLEAR	--	--	Clear multimarker at marker position
:CLR_ALL	--	--	Clear all multimarkers
:A? to :F?	--	--	Output of level and frequency of multimarkers A to F
:FREQUENCY:A? to :FREQUENCY:F?	-- --	-- --	Output of frequency of multimarkers A to F
:LEVEL:A? to :LEVEL:F?	-- --	-- --	Output of level of multimarkers A to F
N_DB_DOWN:LINE :LINE?	0... Level Range INCREMENT DECREMENT ON OFF	DB -- -- -- --	N-dB-down line Increment Decrement on off
PLOT:ADDRESS :ADDRESS? :CURVE :SCREEN :TYPE	0 to 30 -- -- HP_GL DOP	-- -- -- -- --	IEC-bus address of plotter Plot curve Plot screen Plotter code: HP-GL DOP

Command	Data	Units	Meaning
PRINT PRINT:TYPE	-- PDN PDN_COLOR PUD3 NEC_P6 PAINTJET PJ_COLOR THINKJET LASERJET	-- -- -- -- -- -- -- --	Hardcopy on printer Type of printer:R&S PDN R&S PDN Color R&S PUD3 NEC P6/P7 HP Paintjet HP Paintjet Co. HP Thinkjet HP Laserjet
PROBE.CODE	ON OFF DBUV_M DBUA_M DBUA -150 to + 150 dB	-- -- -- -- -- DB	Coding socket on Coding socket off Conversion factor dB μ V \rightarrow dB μ V/m dB μ V \rightarrow dB μ A/m dB μ V \rightarrow dB μ A K-factor
REFERENCE	INTERNAL EXTERNAL	-- --	Internal reference External reference
REFERENCE:LINE :LINE?	(Ref.Level - Level Range) ... Ref.Level INCREMENT DECREMENT ON OFF	DBM -- -- -- --	Reference line Increment Decrement on off
RESOLUTION:COUNTER	10 kHz 1 kHz 100 Hz 10 Hz 1 Hz 0.1 Hz	HZ KHZ MHZ GHZ	Resolution of frequency counter
:BIT :BIT?	1 ns max. sweep time	S Ms Us Ns	Resolution of bit scaling
SCALING:GRID:LINEAR	--	--	Linear scaling in %
:GRID:LOG	--	--	Linear scaling in %
:ABSOLUTE	--	--	Scaling in absolute values
:RELATIVE	--	--	Scaling referred to reference level
:BIT	ON OFF	--	Scaling in bits on off

Command	Data	Units	Meaning
SCREEN:BRIGHTNESS :BRIGHTNESS? :COLOR:GRID :GRID? :CURVE1 :CURVE1? :CURVE2 :CURVE2? :SOFTKEY :SOFTKEY? :BACKGROUND :BACKGROUND? :DEFAULT :COLOR:SET_DEFAULT	0 to 63	--	Brightness
	0-15, 0-15, 0-15	--	Color (R, G, B) Grid
	0-15, 0-15, 0-15	--	Curve 1
	0-15, 0-15, 0-15	--	Curve 2
	0-15, 0-15, 0-15	--	Softkeys
	0-15, 0-15, 0-15	--	Background
	--	--	Default color
	--	--	Setting the default color
SERVICE SERVICE?	a, bb, cc, ddddd	--	Service functions: dddd = 0, if no entry of data is required
SPAN SPAN?	0 to max.	HZ (Default) KHZ MHZ GHZ	Frequency range
	FULL	--	0 to 2 GHz
	ZERO	--	0 Hz
	INCREMENT	--	Increment
	DECREMENT	--	Decrement
	COUPLED	--	Frequency coupling on
	FIXED	--	Frequency coupling off
	LINEAR LOGARITHMIC	-- --	linear frequency axis logarithmic frequency axis
SWEEP:TIME :TIME? :CONTINUOUS :DISPLAY :SINGLE :START	(Span = 0 Hz:) 200 μ s 2 ms 400 μ s 4 ms 800 μ s 8 ms 1 ms 10 ms	S (default) MS US NS	Sweep time
	(Span \geq 0 Hz:) 20 ms to 1980 s		
	INCREMENT DECREMENT	-- --	Increment Decrement
	COUPLED FIXED	-- --	Coupling on Coupling off
	--	--	Continuous sweep
	ON OFF	-- --	Display on/off for single Sweep
	--	--	Single sweep
	--	--	Restart of sweep

Command	Data	Units	Meaning
TERMINATOR	LF_EOI EOI	--	Set terminator for data output
TEXT:LINE1 :LINE1?	#0...	--	Text line 1
:LINE2 :LINE2?	#0...	--	Text line 2
THRESHOLD:LINE :LINE?	(Ref. level Level range) ... Ref. level INCREMENT DECREMENT ON OFF	DBM -- -- -- --	Threshold line Increment Decrement on off
TIME TIME?	hh, mm, ss	--	Time
TIME:LINE1 :LINE1?	0 ... sweep time INCREMENT DECREMENT ON OFF	S MS US NS -- -- -- --	Time line 1 Increment Decrement on off
:LINE2 :LINE2?	"	"	Time line 2
TOLERANCE:LINE1 : : :LINE8 :LINE1? : : :LINE8?	n, freq, lvl (, freq, lvl ...) or n, time, lvl (, time, lvl ...) ON OFF CLEAR COPY,line_nr SHIFT,freq,lvl	-- (n) HZ (freq) KHZ MHZ GHZ S (time) MS US NS DBM (lvl)	Enter sample points of tolerance lines: n: number of sample points (max. 16) freq: sample point frequency time: time of sample point (span = 0) lvl: sample point level Tolerance line on off Copy to line_nr Shift by freq: Frequency difference lvl: level difference

Befehl	Daten	Einheiten	Bedeutung
TRACE?	--	--	New start of sweep and readout of data
TRACE:WRITE	1...4	--	New start of sweep and writing of trace buffer n
:MAXHOLD	1...4	--	Max. hold buffer n
:AVERAGE	1...4	--	Average buffer n
:AVERAGE:SAMPLES :SAMPLES?	0...32767	--	Number of sweeps for average
:VIEW	1...4	--	Stop writing to buffer n
:BLANK	1...4	--	Clear buffer n
:COPY	1...4, 1...4 (n) , (m)	--	Copy buffer n → m
:DIFFERENCE	2...4	--	Form difference Trace 1 = trace 1 – trace n
REF_LINE	--	--	Trace 1 = trace 1 – reference line
OFF	--	--	Difference formation off
:BLOCK:T_1 to :T_4	#0....	--	Write binary data to traces 1 to 4
:T_1? to :T_4?	--	--	Read out traces 1 to 4 binary
:RESTORE:T_1 to :T_4	#0...	--	Write binary data to traces 1 to 4 and restore hardware setting
TRANSDUCER:FACTOR1 : : : :FACTOR4 :FACTOR1? : : :FACTOR4?	n, freq, lvl (, freq, lvl ...)	-- (n) HZ (freq) KHZ MHZ GHZ DB (lvl)	Enter tables w. sample points for antenna correction n: number of sample points (max. 25) freq: sample point frequency lvl: sample point level Correction - on - off - clear table - copy to tab_nr
	ON OFF		
	CLEAR COPY,tab_nr		

Command	Data	Units	Meaning
:TEXT:FACTOR1 : :FACTOR4 :FACTOR1? : :FACTOR4?	#0... --	-- --	Comment to the respective table (max. 80 characters)
TRIGGER:FREE : :LINE : :VIDEO : :EXTERNAL	-- -- -- --	-- -- -- --	Mode of triggering: Free run Line Video Extern
:SLOPE	POSITIVE NEGATIVE	-- --	positive edge negative edge
:LEVEL	0 to 63	--	Trigger level (only for TRIGGER:VIDEO, TRIGGER:EXTERNAL)
	INCREMENT DECREMENT	-- --	Increment Decrement
:LEVEL?			Output of trigger level
UNIT	DBM DB DBUV DBUV_M DBUV_MHZ DBUV_MMHZ DBUA DBUA_M DBUA_MHZ DBUA_MMHZ DBPW DBPT DBPT_MHZ V A W	-- -- -- -- -- -- -- -- -- -- -- -- -- -- -- -- --	Output unit: dBm dB dB μ V dB μ V/m dB μ V/MHz dB μ V/mMHz dB μ A dB μ A/m dB μ A/MHz dB μ A/mMHz dBpW dBpT dBpT/MHz V A W
USER_PORT:A :A?	INPUT OUTPUT 0 to 255	-- -- --	USER PORT A
:B :B?	INPUT OUTPUT 0 to 15	-- -- --	USER PORT B

Additional commands for RECEIVER mode

Command	Data	Units	Meaning
COR_DELAY	100 ms to 100 s INCREMENT DECREMENT ON OFF	S MS US NS -- -- -- --	Delay time Carrier operated Relay Increment Decrement on off
DELTAMARKER DELTAMARKER:TIME	0 ... sweep time INCREMENT DECREMENT ON OFF	S MS US NS -- -- -- --	Delta marker Increment Decrement Delta marker on Delta marker off
DELTAMARKER?	--	--	Output of delta marker time and level
DELTAMARKER:TIME?	--	--	Output of delta marker time
:BIT?	--	--	Output of delta marker bit
:LEVEL?	--	--	Output of delta marker level
:MOD_DEPTH?	--	--	Output of modulation depth (only with AM)
:DEVIATION?	--	--	Output of frequency deviaiton (only with FM)
:OFFSET?	--	--	Output of frequency offset (only with FM)
:PEAK	--	--	Peak-Search
:NEXT_PEAK	--	--	Next Peak Search
:MIN	--	--	Minimum Search
:NEXT_MIN	--	--	Next Min Search
DEMODULATION:AM	100% 10%	PCT	Type and range of demodulation
:FM	200kHz 20kHz 2kHz 200Hz COUPLED	HZ KHZ MHZ GHZ --	Automatic matching to resolution bandwidth

Command	Data	Units	Meaning
FREQUENCY:RECEIVER :RECEIVER?	0 to max. INCREMENT DECREMENT	HZ KHZ MHZ GHZ -- --	Demodulation frequency Increment Decrement
:RECEIVER :STEPSIZE :STEPSIZE?	"	"	Step size of demodulation frequency
MARKER MARKER:TIME	0... Ablaufzeit INCREMENT DECREMENT ON OFF	S Ms Us Ns -- -- -- --	Change marker time Increment Decrement Marker on Marker off
MARKER?	--	--	Output of marker time and level
MARKER:TIME? :LEVEL?	-- --	-- --	Output marker time Output marker level
:FORM	TRIANGLE CIRCLE CROSS X_CROSS	-- -- -- --	Change marker form - Triangle - Circle - Cross - X cross
:PEAK :NEXT_PEAK :MIN :NEXT_MIN	-- -- -- --	-- -- -- --	PeakSearch Next Peak Search Minimum Search Next Min Search
SQUELCH SQUELCH?	-150 to 30 dBm INCREMENT DECREMENT ON OFF	DBM -- -- -- --	Squelch level Increment Decrement on off
VOLUME VOLUME?	0 to 63	--	Volume

2.4.1.5 Service Request and Status Register

The following Fig. shows the status registers and the effective links between them. To remain in accordance with the IEEE 488.2 standard, the Status Byte (STB) and its associated mask register (SRE), which are also present with older devices, have been supplemented by the Event Status Register (ESR) and its Event Status Enable Mask Register (ESE).

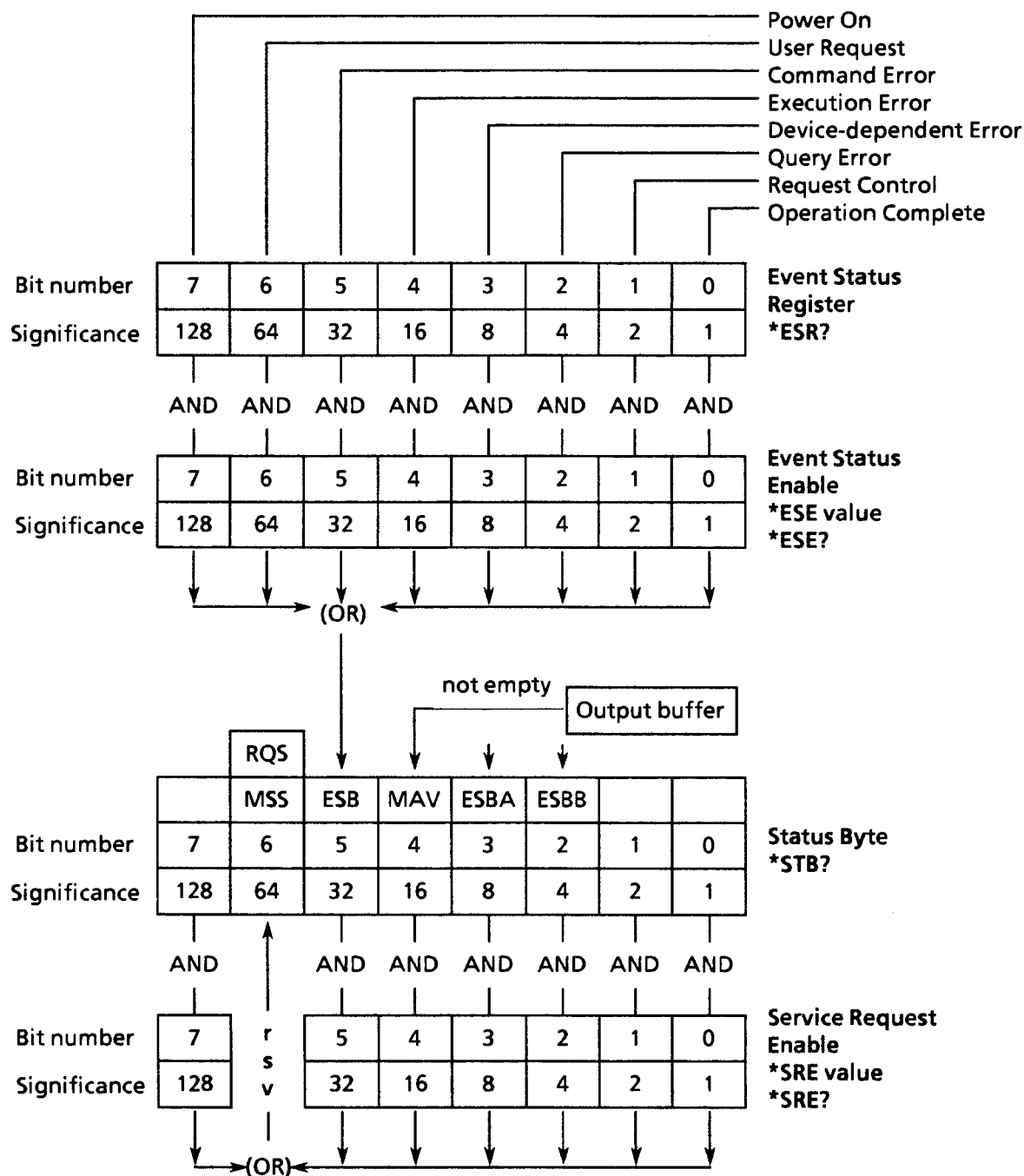

Fig. 2-7 Status registers

A bit is set to "1" in the ESR in the case of certain events (e.g. fault, ready signal), see Table 2-11. These bits remain set until they are cleared by reading the ESR (by the command *ESR?) or by the following conditions:

- The commands *RST or *CLS
- Switching on the AC supply (the power-on bit is, however, set in this case).

Using the ESE mask register, the user can select the bits in the ESR which also set the sum bit ESB (bit 5 in the status byte) via which a service request can be triggered. The sum bit is therefore only set if at least one bit in the ESR and the corresponding bits in the ESE are set to "1". The sum bit is automatically cleared again if the previous condition is no longer fulfilled, e.g. if the bits in the ESR have been cleared by reading the ESR or if the ESE has been modified.

The ESE mask register is written by the command "*ESEvalue" ("value" is the contents in decimal form) and can be read again by the command *ESE?. It is set to "0" when the AC power is switched on if the power on status clear flag is "1" (*PSC1). The ESE mask register is not changed by other commands or interface messages (DCL, SDC).

The bits listed in Table 2-10 are used in the status byte (STB):

Table 2-10 Bit allocation of status byte

Bit number	Bus line	Designation	Meaning
2	DIO 3	ESBB	Sum bit of the Event Status Register B for overload check during the sweep.
3	DIO 4	ESBA	Sum bit of the Event Status register A for limit check on tolerance lines T1 to T8.
4	DIO 5	MAV	Message Available Indicates that a message, which can be read, is present in the output buffer. The bit is "0" if the output buffer is empty.
5	DIO 6	ESB	Sum bit of the Event Status Register
6	DIO 7	RQS	Request Service

Note that the status register bits are numbered from 0 to 7 in compliance with the standard, but the bus data lines are designated DIO1 to DIO8.

Event-Status Register A:

To remain in accordance with the IEEE 488.2 standard defining registers ESR and ESE, an Event Status Register A "ERA" and its associated Enable register "ERAЕ" have additionally been defined in the analyzer to control bit 3 "ESBA" in the status byte .

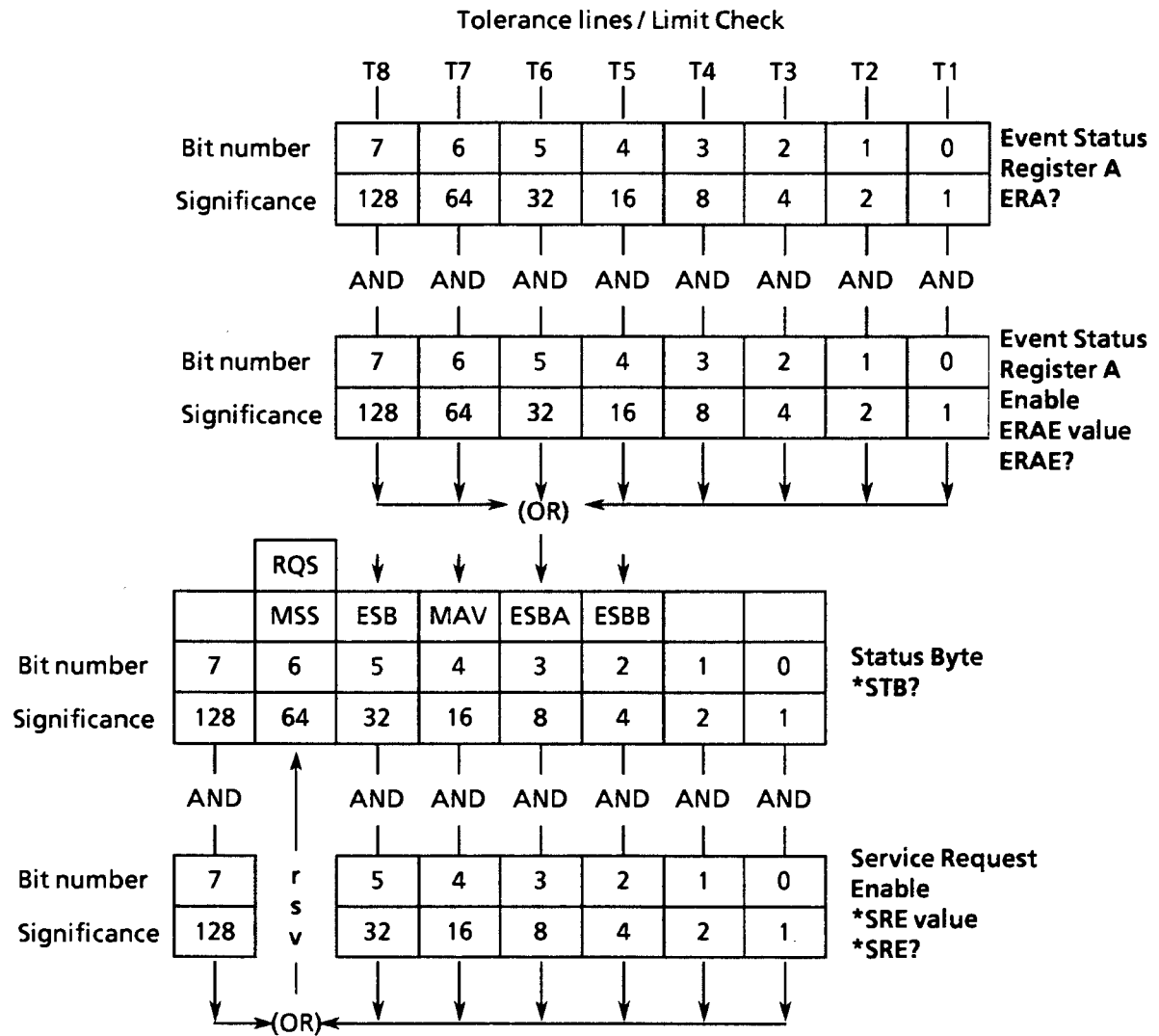

Fig. 2-8 Event Status Register A

With Limit Check activated the associated bit in the Event Status Register ERA is set for the respective tolerance line T1 to T8 at the end of a sweep in case of violation of the upper or lower limit ("LIMITCHECK:LINE1 UPPER" or "LIMIT-CHECK:LINE1 LOWER").

Event-Status Register B:

To remain in accordance with the IEEE 488.2 standard defining registers ESR and ESE, an Event Status Register B "ERB" and its associated Enable register "ERBE" have additionally been provided in the analyzer to control bit 2 "ESBB" in the status byte.

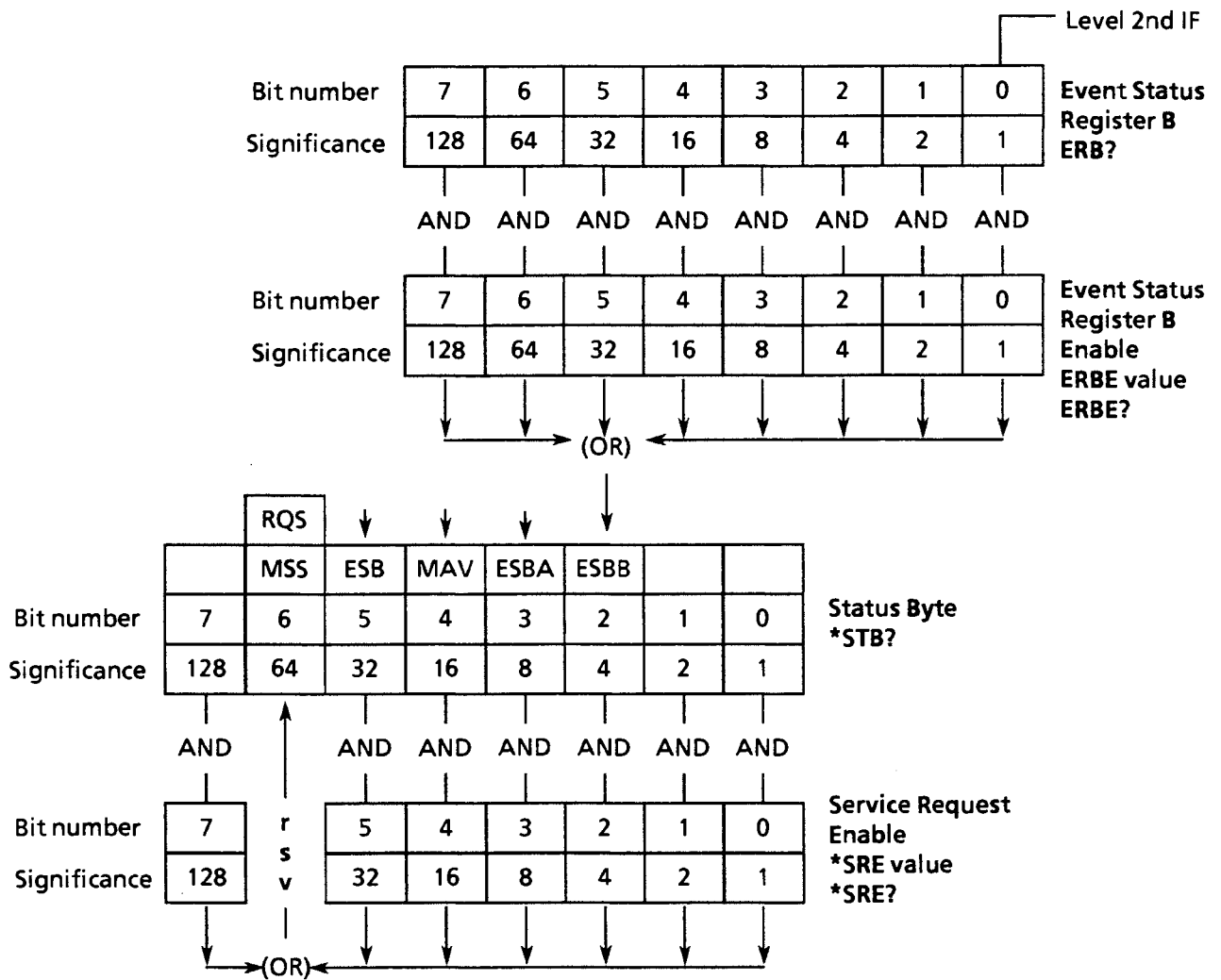

Fig. 2-8a Event Status Register B

If the warning of the overload display "Level 2nd IF" is given during a sweep, the associated bit is set in the Event Status Register B.

Table 2-11 Bit allocation of ESR

Bit-Number	Meaning
7	<p>Power On</p> <p>Is set when the instrument is switched on or if the power returns following a failure.</p>
6	<p>User Request</p> <p>The user can set this bit by actuating the LOCAL key – irrespective of whether the instrument setting is REMOTE or LOCAL – and thus generate a Service Request with a corresponding setting of the mark registers. This function is useful if test routines require manual operation as well as control via the IEC bus.</p>
5	<p>Command Error</p> <p>Is set if one of the following faults is detected in the received commands:</p> <ul style="list-style-type: none"> ● Syntax error ● Illegal unit ● Illegal header ● A number has been combined with a header where no number is allowed.
4	<p>Execution Error</p> <p>Is set if one of the following errors was detected during execution of the received commands</p> <ul style="list-style-type: none"> ● A number is outside the permissible range (for the respective parameter). ● A received command is not compatible with the current device setting.
3	<p>Device-dependent Error</p> <p>Is set if functional errors occur. The error messages of ERROR REPORT can be polled using the command "ERRORS:REPORT?".*)</p>
2	<p>Query Error</p> <p>This bit is set:</p> <ul style="list-style-type: none"> ● If the controller wishes to read data from the analyzer but no query message has previously been output. ● If the data present in the output buffer of the analyzer have not been read out and a new command was sent to the instrument instead. The output buffer is cleared in this case.
1	<p>Request Control</p> <p>Is used by the device to obtain the controller function for the plotter after a "PLOT:CURVE" or "PLOT SCREEN" command.</p>
0	<p>Operation Complete</p> <p>This bit is set by the commands *OPC and *OPC? if all previous commands have been executed.</p>

*) In contrast thereto, the overload message "Level 2nd" is represented in the additional status register ERB.

Using the SRE mask register, the user can determine whether the ESB, ESBA, ESBB and/or MAV bits of the status byte are set, and whether a Service Request is sent to the controller by activating the SRQ line. Since each bit in the SRE mask register is assigned to the corresponding bit in the status byte, the following possibilities result (see Table 2-12), and the combinations thereof.

Table 2-12 Bit allocation of the SRE

Contents of SRE (decimal)	Set bit No. in SRE	Effect
0	--	No Service Request
4	2	Service Request if ESBB bit is set (at least 1 bit set and not masked in the ESR B)
8	3	Service Request if ESBA bit is set (at least 1 bit set and not masked in the ESR A)
16	4	Service Request if MAV bit is set (message in output buffer)
32	5	Service Request if ESB bit is set (at least 1 bit set and not masked in the ESR)

The Service Request Enable mask register (SRE) is written by the command `*SRE value` ("value" is the contents in decimal form) and can be read again by the command `*SRE?`. It is set to "0" when the AC power is switched on, if the power-on clear flag is "1"; the Service Request function of the analyzer is thus disabled. The SRE mask register is not changed by other commands or interface messages (DCL, SDC).

Several devices can trigger a Service Request simultaneously, the open collector drivers generate an OR function on the SRQ line. The controller must read the status bytes of the devices in order to identify the device which has triggered the Service Request. A set RQS bit (bit 6/DIO7) indicates that the device is sending a Service Request.

The status byte of the analyzer can be read in the following manner:

- By the command `*STB?`.

The contents are then output in decimal form. The status byte is not changed by reading out, and the Service Request is not cleared.

- By a Serial Poll.

(With R&S controllers: IEC SPL adr, status.) The contents are transferred in binary form as one byte. The RQS bit is then set to "0" and the Service Request becomes inactive; the other bits of the status byte are not changed.

The status byte is cleared:

- By the command `*CLS`.

This command clears the ESR; the ESB bit in the status byte is also set to "0". This may clear the RQS bit and the Service Request.

- By reading the ESR (`*ESR?` command) or setting the ESE mask register to "0" (`*ESE` command) and by reading the contents of the output buffer.

Parallel Poll Enable Register PPE

The Parallel Poll Enable Register is a sixteen bit wide register. Each bit in this register corresponds to a bit in the status byte or a device-specific register (not implemented in the FSA). If the bitwise combination of the Parallel Poll Enable Register with the two others does not equal 0, the IST (individual state) bit is set to "1". The IST bit is sent in response to a parallel poll from the controller, which allows to identify the participating device requesting service. (The IST bit can also be read with "*IST?")

Fig. 2-8b is given for better illustration.

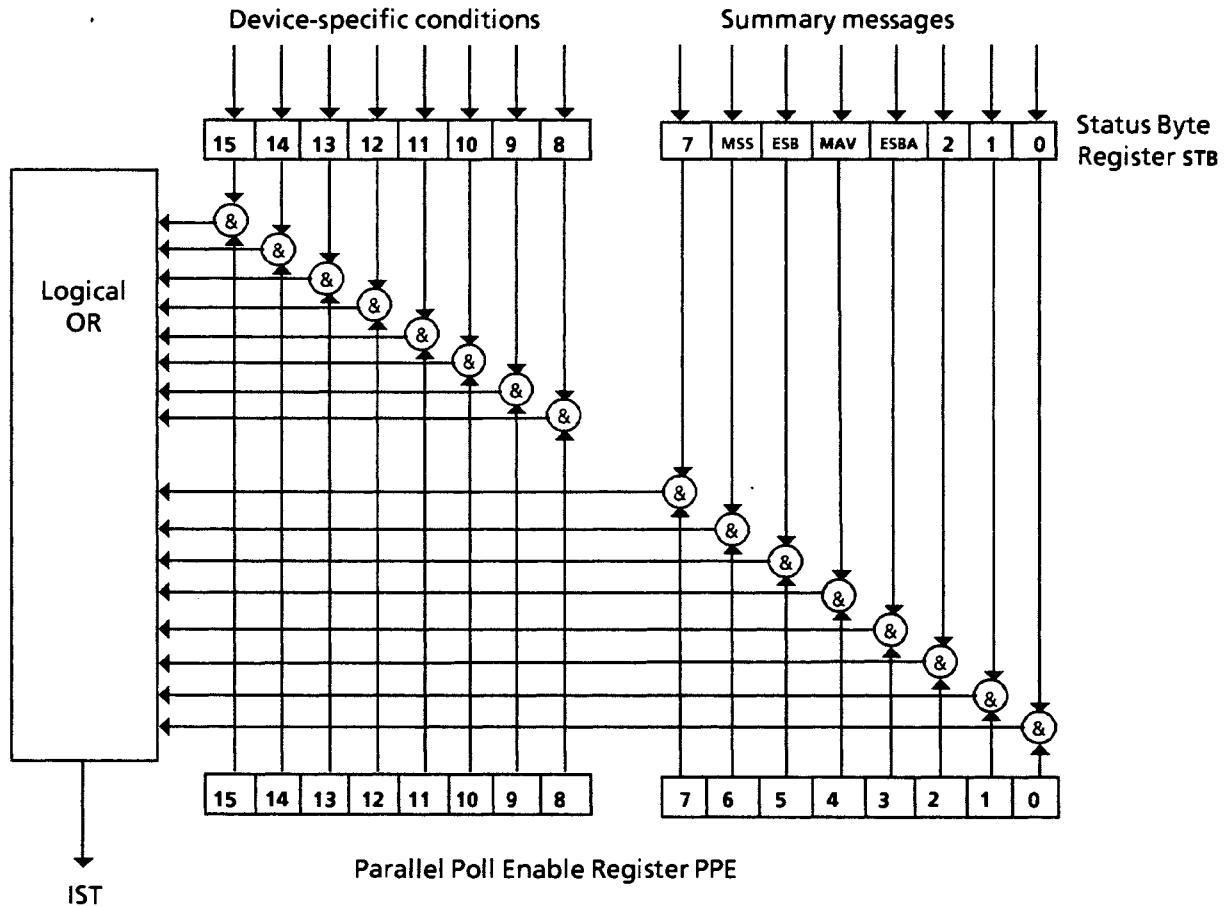

Fig. 2-8b Parallel Poll Enable Register PPE

2.4.1.6 Resetting of Device Functions

The following table lists the various commands and events which cause individual device functions to be reset.

Table 2-13 Resetting of various device functions

Event	Power on		DCL, SDC (Device Clear, Selected Device Clear)	Commands	
	Power-on-clear flag			*RST	*CLS
	0	1			
Basic device setting	--	--	--	Yes	--
Set Event Status Registers ESR, ERA and ERB to zero	Yes	Yes	--	--	Yes
Set mask registers ESE, ERAE, ERBE and SRE to zero	--	Yes	--	--	--
Clear output buffer	Yes	Yes	Yes	--	--
Clear Service Request	Yes	1)	2)	3)	3)
Reset command processing and input buffer	Yes	Yes	Yes	--	--

- 1) Yes, but "Service Request on power on" is possible.
 2) Yes, if only caused by message in output buffer.
 3) Yes, if not caused by message in output buffer.

2.4.1.7 Command Processing Sequence and Synchronization

The commands received by the analyzer are first stored in an input buffer which can accommodate up to 2560 characters. Once the terminator has been received, the commands are processed in the sequence in which they were sent. During this time, the IEC bus can be used for communication with other devices. Command lines which exceed the capacity of the input buffer are processed in several sections. The bus is occupied during this time.

OPERATION COMPLETE:

The commands *OPC and *OPC? (operation complete) are used as feedbacks to inform on the time at which processing of the received commands was terminated and a sweep (if any) has been completely executed.

*OPC sets bit 0 in the ESR, and a Service Request can then be triggered if all previous commands have been executed.

*OPC? additionally provides a message in the output buffer and sets bit 4 (MAV) in the status byte.

For synchronization with a complete sweep the function "Operation Complete" can be used with the following commands:

```
SWEEP: START
*TRG
SWEEP: CONTINUOUS
```

This particularly applies to the commands "AUTO:RANGE" and "MARKER:ZOOM".

Also, synchronization is performed with the calibration routines "CALIBRATION:TOTAL" etc.

WAIT:

This synchronization can be established within a command line by the command "*WAI", i.e. all subsequent commands are only executed when the previous commands have been completely executed. This may be favourable in the case of very short sweep times.

2.4.1.8 Error Handling

All errors detected by the analyzer in connection with operation via the IEC bus are indicated in the ESR by setting a bit (bit 2, 4 or 5, see Table 2-11). Function faults are signalled by setting of bit 3. These bits remain set until the ESR is read or is cleared by the commands *RST or *CLS. This is in line with the standard IEEE 488.2 and enables triggering of a Service Request and program-controlled evaluation of the type of error.

The Query command "ERRORS?" allows for a detailed error detection (see Table 2-9, "ERRORS:REPORT?").

2.4.1.9 Programming Examples

The following section is provided to give the user an easy approach to programming the analyzer via IEC bus.

The examples are tailored to the Rohde & Schwarz BASIC (version 2.02) but can easily be varied for application at other controllers.

The examples are successively completed by further functional parts, which are explained in detail.

Note:

Generally, all programs should be given procedure names and labels to be independent of BASIC line numbers.

At the beginning of a program the terminator "LF" (acc. to standard IEEE488.2 the only legal terminator) should be set for the system controller.

```
10000Prolog:
10010                                REM Setup Controller
10020    IEC TERM 10: IEC TIME 5000
10030                                REM Analyzer Bus Address
10040    Fsa=20
10050                                REM ... other init stuff
10060    False%=0: True%=1
10070    RETURN
10080 REM -----
```

The variables False% and True% are used in the examples for a better understanding of the program.

Apart from the setting for the IEC bus, the initialization of the devices attached is necessary:

```
10100Fsa_reset:
10110                                REM Reset status reg's
10120                                REM and analyzer setting
10130    IEC OUT Fsa,"*CLS;*RST"
10140    RETURN
10150 REM -----
```

Example 1: Sending a setting command

The first example shows how to send a setting command to the analyzer, in order to set a center frequency of 100 MHz and a span of 1 MHz.

```
100 REM ===== Send commands to analyzer
110 REM prologue + reset device
120 GOSUB Prolog
130 GOSUB Fsa_reset
140 REM send new setting
150 IEC OUT Fsa,"FREQUENCY:CENTER 100MHZ; SPAN 1MHZ"
160 REM
170 END
180 REM =====
10000Prolog:
10010 REM Setup Controller
10020 IEC TERM 10: IEC TIME 5000
10030 REM Analyzer Bus Address
10040 Fsa=20
10050 REM ... other init stuff
10060 RETURN
10070 REM -----
10100Fsa_reset:
10110 REM Reset status reg's
10120 REM and analyzer setting
10130 IEC OUT Fsa,"*CLS;*RST"
10140 RETURN
10150 REM -----
```

This example also contains the procedures "Prolog" and "Fsa_reset"; in the following examples only the new program parts are listed.

Example 2: Reading a setting

This example is used for sending the same setting to the analyzer as in example 1, but with abbreviated commands. The sweep time which is automatically set by the instrument is then read and output on the screen:

```
100 REM ===== Read analyzer settings
110 REM Init section
120 GOSUB Prolog
130 GOSUB Fsa_reset
140 REM Setup analyzer
150 IEC OUT Fsa,"F:C 100M;SPAN 1M"
160 REM Read device setting
170 IEC OUT Fsa,"SWEEP:TIME?"
180 IEC IN Fsa,Swptime$
190 PRINT Swptime$
200 END
210 REM =====
```

Example 2: Sweep and synchronization

The program part for synchronization with sweep is often required, e.g. to evaluate the peak signal after a complete sweep. The easiest way to obtain the synchronization is by using the "*WAI" command. The IEC bus commands in the example below are not executed until completion of the sweep; the bus, however, is busy during this time.

This simple procedure should be applied when short sweep times are set on the analyzer and no further actions are planned on the controller during the sweep.

Example 3a: WAIT command

```
100 REM ===== take sweep,wait + read peak
110                      REM Init section
120  GOSUB Prolog
130  GOSUB Fsa_reset
140                      REM setup analyzer
150  IEC OUT Fsa,"F:C 100M;SPAN 1M"
160                      REM take sweep and wait
170  IEC OUT Fsa,"SWEEP:START;*WAI"
180                      REM marker to peak signal
190  IEC OUT Fsa,"MARKER:PEAK;MARKER?"
200  IEC IN Fsa,Marker$
210                      REM freq. + level of marker
220  PRINT Marker$
230  END
240 REM =====
```

A second possibility of synchronization is provided by the command *Operation Complete* "*OPC?" or "*OPC" which can be used with or without Service Request (for *OPC?).

The *OPC? command forces the device to send a message to the output buffer and to simultaneously set the MAV bit in the status byte. The output of the message may now be waited for - which corresponds to the *WAI command procedure - or, with appropriate configuration, a Service Request can be triggered. It is not necessary for the message to be read, since sending further commands to the analyzer automatically causes the output buffer to be cleared.

Example 3b:*OPC? query without Service Request

```
100 REM ===== take sweep, sync + read peak
110 REM Init section
120 GOSUB Prolog
130 GOSUB Fsa_reset
140 REM setup analyzer
150 IEC OUT Fsa, "F:C 100M; SPAN 1M"
160 REM start sweep
170 IEC OUT Fsa, "SWEEP:START;*OPC?"
180 REM sync by read OPC msg
190 IEC IN Fsa, Dummy$
200 REM marker to peak signal
210 IEC OUT Fsa, "MARKER:PEAK;MARKER?"
220 IEC IN Fsa, Marker$
230 REM freq. + level of marker
240 PRINT Marker$
250 END
260 REM =====
```

Example 4: Service Request

The most flexible method of synchronizing the sweep is represented by the *Service Request*.

The system controller is provided with an interrupt routine which can be processed upon every Service Request (asynchronous to the normal program run).

During this procedure the calling devices are determined by polling. The status byte information then initiates the device-specific actions accordingly.

The following statement is added to the main program for enabling the controller to service interrupt routines:

```
nnn ON SRQ GOSUB Srq_interrupt
```

The following example shows a Service-Request routine

Example 4a: Service Request Routine

```
12000Srqr_interrupt:
12010                                REM SRQ Interrupt
12020                                REM Poll analyzer
12030    IEC SPL Fsa,Stb%
12040    IF (Stb% AND 64)=0 THEN GOTO Poll_next_device
12050                                REM Analyzer request
12060    Fsa_srq%=True%
12070                                REM Clear status reg's
12080    IEC OUT Fsa,"*CLS"
12090Poll_next_device:
12100                                REM ... poll other devices
12110Srqr_exit:
12120                                REM reenable SRQ-Interrupt
12130    ON SRQ1 GOSUB Srqr_interrupt: RETURN
12140 REM -----
```

This Service Request routine may be extended for servicing further devices attached and/or additionally evaluating error messages via the Event Status register.

The configuration of the *Event Status register* ESE and the *Service Request Enable* register must be appropriate for the analyzer to generate a Service Request at the end of a sweep.

Bit 0 is set in the Event Status register at the end of a sweep by the *OPC command - thus generating a Service Request, if released by the mask register SRE.

The routine of the example below is used for configuration of the registers, for triggering a sweep and for synchronization to the sweep end. In this simple example this is achieved by testing the Boolean variable Fsa-srq% set in the Service Request routine.

Of course, a series of other actions can be carried out in the controller within this sequence, such that parallel processing is done between analyzer and controller.

The controller does not check the complete sweep until this is required by the subsequent actions.

Example 4b: Sweep with Service Request

```
10300Take_sweep:
10310                                REM take sweep with sync
10320    Fsa_srq%=False%
10330                                REM enable SRQ on OPC
10340    IEC OUT Fsa,"*CLS;*ESE 1;*SRE 32"
10350                                REM start single sweep
10360    IEC OUT Fsa,"SWEEP:START;*OPC"
10370                                REM loop: sweep end?
10380Wait_for_sweep_complete:
10390    IF Fsa_srq%=False% THEN GOTO Wait_for_sweep_complete
10400                                REM that's it !
10410    RETURN
10420 REM -----
```

New routines have been added to the complete example for control of the sweep with Service Request as shown in the following:

Example 4c: Sweep synchronisation with Service Request

```

100 REM ===== take sweep, sync + read peak
110 REM Init section
120 GOSUB Prolog
130 GOSUB Fsa_reset
140 REM enable SRQ-interrupt
150 ON SRQ1 GOSUB Srq_interrupt
160 REM setup analyzer
170 IEC OUT Fsa, "F:C 100M;SPAN 1M"
180 REM now take one sweep
190 GOSUB Take_sweep
200 REM marker to peak signal
210 IEC OUT Fsa, "MARKER:PEAK;MARKER?"
220 IEC IN Fsa, Marker$
230 REM freq. + level of marker
240 PRINT Marker$
250 END
260 REM =====
10300 Take_sweep:
10310 REM take sweep with sync
10320 Fsa_srq%=False%
10330 REM enable SRQ on OPC
10340 IEC OUT Fsa, "*CLS;*ESE 1;*SRE 32"
10350 REM start single sweep
10360 IEC OUT Fsa, "SWEEP:START;*OPC"
10370 REM loop: sweep end?
10380 Wait_for_sweep_complete:
10390 IF Fsa_srq%=False% THEN GOTO Wait_for_sweep_complete
10400 REM that's it !
10410 RETURN
10420 REM -----
12000 Srq_interrupt:
12010 REM SRQ Interrupt
12020 REM Poll analyzer
12030 IEC SPL Fsa, Stb%
12040 IF (Stb% AND 64)=0 THEN GOTO Poll_next_device
12050 REM Analyzer request
12060 Fsa_srq%=True%
12070 REM Clear status reg's
12080 IEC OUT Fsa, "*CLS"
12090 Poll_next_device:
12100 REM ... poll other devices
12110 Srq_exit:
12120 REM reenable SRQ-Interrupt
12130 ON SRQ1 GOSUB Srq_interrupt
12140 RETURN
12150 REM -----

```

Example 5: Output to the plotter

The *Pass Control* protocol is used by the controller for output of the complete screen contents or the measuring curve from the analyzer to the IEC bus plotter.

This means that the controller function is passed to the analyzer for control of the plotter. The analyzer then addresses the plotter as listener. After plotter output the controller function is again passed to the controller.

The *Pass Control Back* command "PCB" is used to inform the device about the address of the controller to which the controller function was returned again.

The controller can perform further actions during the plotter output - except for IEC bus control of devices. The "Wait Take Control" command is used for waiting for the analyzer to pass the controller function.

```
10500Plot_screen:
10510                                REM controller address
10520    Controller=1
10530                                REM configure PCB
10540    IEC ADR Controller: IEC OUT Fsa,"*PCB "+STR$(Controller)
10550                                REM send plot command
10560    IEC OUT Fsa,"PLOT:SCREEN"
10570                                REM pass control > analyzer
10580    IEC TAD Fsa: IEC TCT
10590                                REM wait for plot complete
10600    IEC WTCT
10610                                REM that's it !
10620    RETURN
10630 REM -----
```

Example 6: Reading trace data and instrument settings

The contents of traces 1 to 4 can be read from the analyzer with the appropriate query. This also applies for the associated instrument setting required for measuring the trace record. This record is transferred with binary notation and consists of 2190 bytes. The first 1802 bytes represent 901 measuring values of the trace, the following represent the complete instrument setting. For binary data transfer the analyzer is configured to terminate on EOI, since a terminator cannot be identified in binary mode.

The records read in can be saved on disk - with the variable Filename\$ being preassigned in this case.

An array is required to read in binary data, which must be dimensionized accordingly.

Example 6a: Reading in and storing trace data

```
10700Tr1_store:
10710                                REM store trace 1 on disk
10720    OPENO# 1,Filename$
10730                                REM terminator EOI
10740    IEC TERM 1
10750                                REM read trace 1
10760    IEC OUT Fsa,"TRACE:BLOCK:T_1?"
10770    IEC IN Fsa,Tr1$
10780                                REM store and close file
10790    PRINT# 1,Tr1$: CLOSE# 1
10800                                REM restore terminator
10810    IEC TERM 10
10820    RETURN
10830 REM -----
```

The instrument data read in above the trace data are coded according to the table in Section 2.4.1.10. The values for the reference level, the measuring range and the reference level offset can be used to convert trace data (corresponding to the A/D converter values) to level values. When restoring the trace data the trace buffer can either only be displayed (Example 6b) or completely reconfigured together with the instrument setting (Example 6c)

Example 6b: Transfer of trace data to the analyzer

```
10840Tr1_load:
10850                                REM load trace_1
10860    OPENI# 2,Filename$
10870    Tr1$=INPUT$(2500,#2): CLOSE# 2
10880                                REM config. binary transfer
10890    IEC OUT Fsa,"TERMINATOR EOI"
10900                                REM send trace_1 data
10910    IEC OUT Fsa,"TRACE:BLOCK:T_1 #0"+Tr1$
10920                                REM reconfigure to default
10930    IEC OUT Fsa,"TERMINATOR LF_EOI"
10940    RETURN
10950 REM -----
```

Example 6c: Restoring trace data and instrument setting

```
10960Tr1_restore:
10970                                     REM restore trace + setting
10980   OPENI# 2,Filename$
10990   Tr1$=INPUT$(2500,#2): CLOSE# 2
11000                                     REM config. binary transfer
11010   IEC OUT Fsa,"TERMINATOR EOI"
11020                                     REM send trace_1 + setting
11030   IEC OUT Fsa,"TRACE:RESTORE:T_1 #0"+Tr1$
11040                                     REM reconfigure to default
11050   IEC OUT Fsa,"TERMINATOR LF_EOI"
11060   RETURN
11070 REM -----
```

The following programming example shows the handling of routines by saving a measurement on a disk. The array size must be sufficiently dimensioned and the file name - including the path name - preassigned.

Example 6d: Measurement with subsequent saving on disk

```
100 REM ===== take sweep and save on disk
110                                     REM Init section
120   GOSUB Prolog
130   GOSUB Fsa_reset
140                                     REM enable SRQ-interrupt
150   ON SRQ1 GOSUB Srq_interrupt
160                                     REM define array + filename
170   DIM Tr1$(2500)
180   Filename$="A:TRACE1.DAT"
190                                     REM setup analyzer
200   IEC OUT Fsa,"F:C 100M;SPAN 1M"
210                                     REM now take one sweep
220   GOSUB Take_sweep
230                                     REM marker to peak signal
240   IEC OUT Fsa,"MARKER:PEAK;MARKER?"
250                                     REM store trace_1 on disk
260   GOSUB Tr1_store
270   END
280 REM =====
```

Example7: Fast readout of trace data

As in the preceding examples, also in this case a trace record is read out from the instrument. This is achieved by the "TRACE"? command which initiates several actions in the analyzer:

- Start of a sweep (without graphics display on screen)
- Synchronization to end of sweep
- Output of the binary trace data via the IEC bus

In this example, 10 sweeps are saved in one record for subsequent evaluation. Saving of the trace record is carried out in parallel to the next measurement. Sweep rates of approx. 130 ms including saving on hard disk are thus obtained.

```
100 REM ===== take 10 sweeps+save on disk
110 REM Init section
120 GOSUB Prolog
130 GOSUB Fsa_reset
140 REM define array + filename
150 DIM Tr$(2500)
160 Filename$="TRACE.DAT": OPENO# 1,Filename$
170 REM EOI for binary transfer
180 IEC TERM 1
190 REM setup analyzer
200 IEC OUT Fsa,"F:C 100M;SPAN 10M;SWEEP:SINGLE"
210 REM now take one sweep
220 IEC OUT Fsa,"TRACE?": IEC IN Fsa,Tr$
230 REM loop for 9 sweeps
240 FOR I=1 TO 9
250 IEC OUT Fsa,"TRACE?": PRINT# 1,Tr$: IEC IN Fsa,Tr$
260 NEXT I
270 REM save last sweep on disk
280 PRINT# 1,Tr$
290 CLOSE# 1
300 END
310 REM =====
```

2.4.1.10 Trace Record

The trace record consists of 2190 bytes. The first 1802 bytes represent the 901 A/D converter values of the trace buffer. The following bytes represent the complete instrument setting:

0000: int trace_buffer [901]

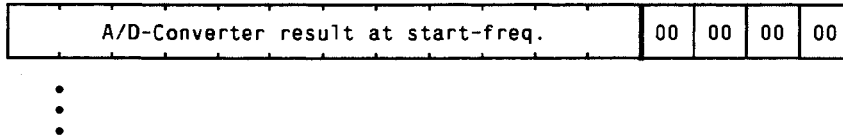

1800:

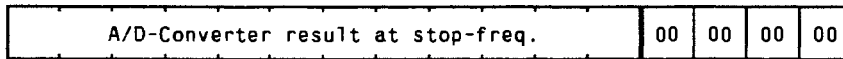

Calculation of the level value

For conversion of the binary trace data into level values, the 16-bit values must be shifted by 4 bits to the right. Due to the 12-bit resolution of the A/D converter, the result is a value between 0 and 4095. The value "3938" corresponds to the reference level set.

Level conversion:

1. Log. Scaling

$$level[i] = \frac{(buffer[i] \gg 4) - 3938}{3938} \cdot range + ref. level$$

2. Lin. Scaling

$$level[i] = 2000 \cdot \lg \left[\frac{(buffer[i] \gg 4)}{3938} \right] + ref. level$$

Level, range and ref. level are indicated in 1/100 dB.

1802: unsigned char state [0]

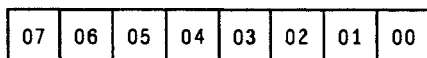

Function:	0	---
	1	Power Up Display
	2	---
	3	Frequency Analyzer
	4	Scalar Network Analyzer
	5	---
	6	Communication Analyzer
	7	Receiver
	8	---
	9	---
	10	Setup

1803: unsigned char state [1]

07	06	05	04	03	02	01	00
----	----	----	----	----	----	----	----

- Hardkey:**
- 0 ---
 - 1 ---
 - 2 Special Function
 - 3 Display Line
 - 4 Marker
 - 5 Multi Marker
 - 6 Sweep
 - 7 Trace
 - 8 Trigger
 - 9 Coupled Function
 - 10 Auto
 - 11 Frequency
 - 12 Span
 - 13 Reference Level
 - 14 Level Range
 - 15 Units
 - 16 ---
 - 17 ---
 - 18 Main-Menu Receiver
 - 19 Receiver Frequency
 - 20 Receiver Display Line
 - 21 Receiver Marker
 - 22 Main-Menu Scalar Network
 - 23 ---
 - 24 Main-Menu Communication Analyzer

1804: unsigned char state [2]

07	06	05	04	03	02	01	00
----	----	----	----	----	----	----	----

- Hardkeys/
Data entry:**
- 0 nothing active
 - 2 Screen
 - 3 Display
 - 5 Plot
 - 6 Help
 - 7 Save
 - 8 Recall
 - 9 Hold
 - 10 Mode
 - 20 Float
 - 21 Signed Float
 - 22 Integer
 - 23 Signed Integer
 - 24 Number

- 1805: int reference [0]** Reference Level * 0.01 dB
- 1807: int reference [1]** Reference Level Offset * 0.01 dB
- 1809: int tglevel** Level Tracking Generator * 0.01 dB
- 1811: int tgoffset** Leveloffset Tracking Gen. * 0.01 dB
- 1813: unsigned char rfatt** RF-Attenuation * 1 dB
- 1814: unsigned char tgatt** TG-Attenuation * 1 dB
- 1815: int mixlev** Mixer level * 0.01 dB

1817: unsigned char gain [0] Range Frequency Analyzer

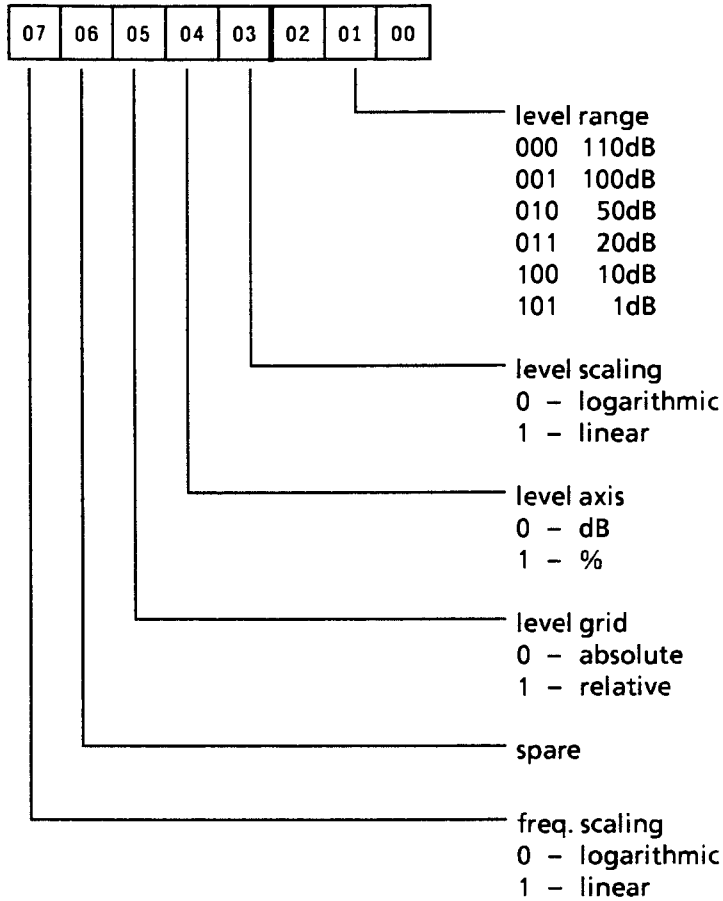

1818: unsigned char gain [1] spare

1819: unsigned char gain [2] Units

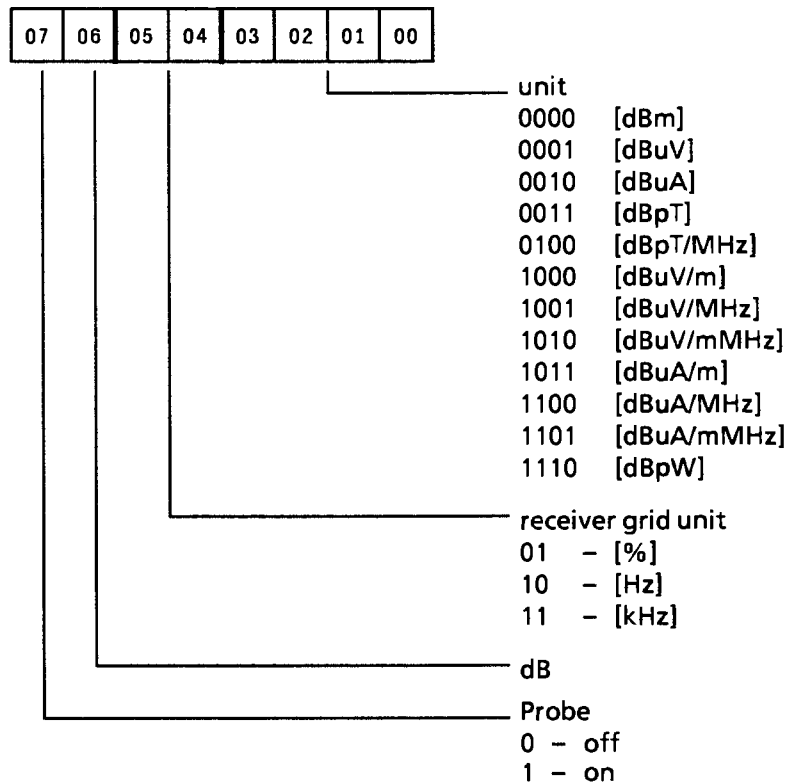

1820: unsigned char mode [0] Trace 1

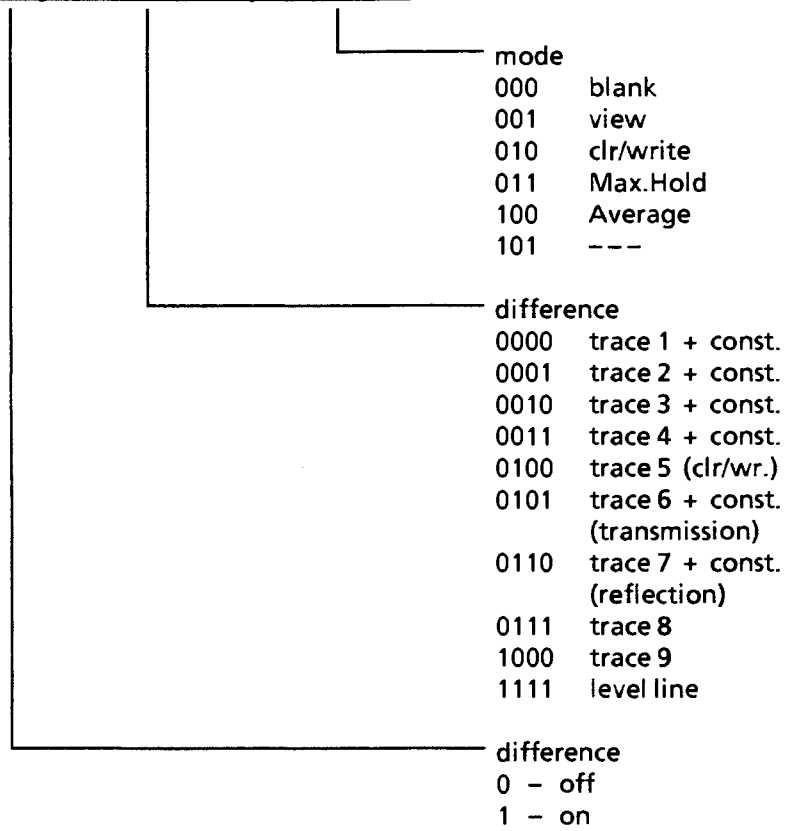
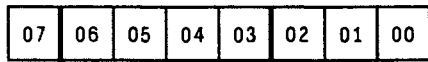

1821: unsigned char mode [1] Trace 2

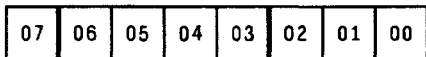

same as trace 1

1822: unsigned char mode [2] Trace 3

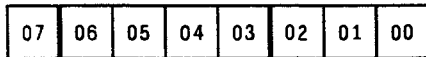

same as trace 1

1823: unsigned char mode [3] Trace 4

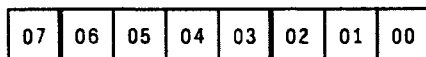

same as trace 1

1824: unsigned char mode [4] Sweep

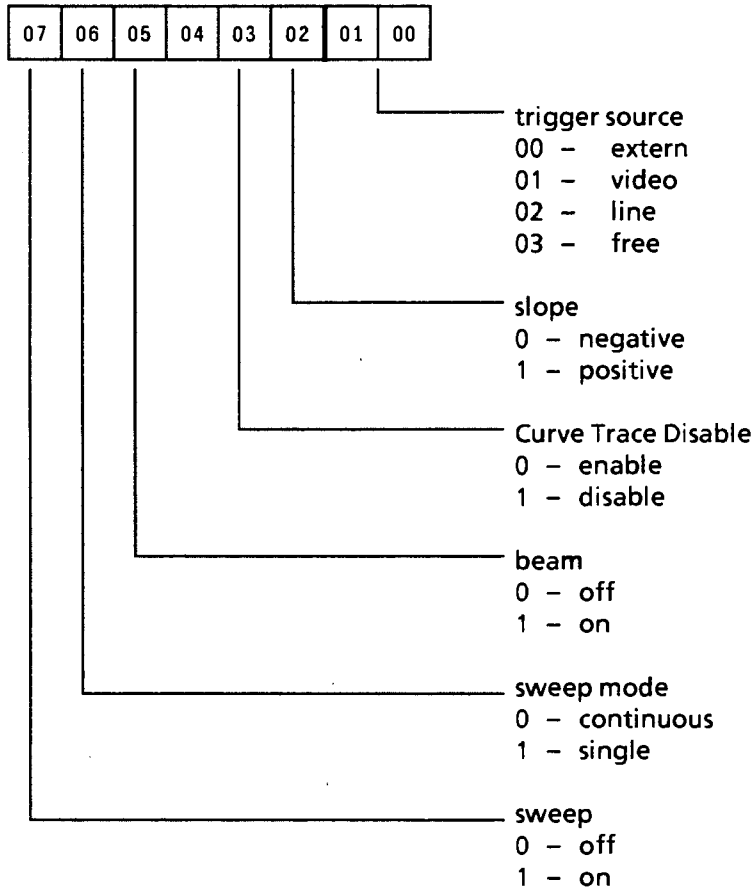

1825: unsigned char mode [5] Coupling

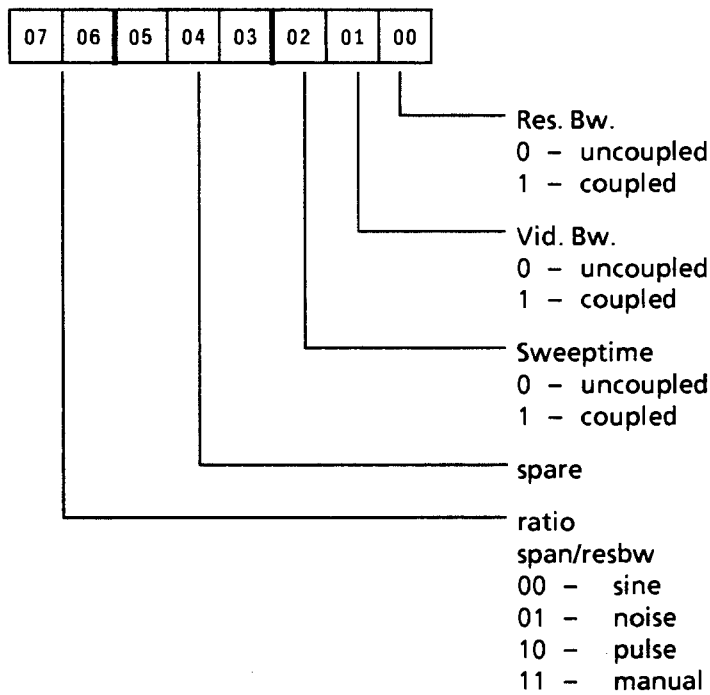

1826: unsigned char mode [6] Auto

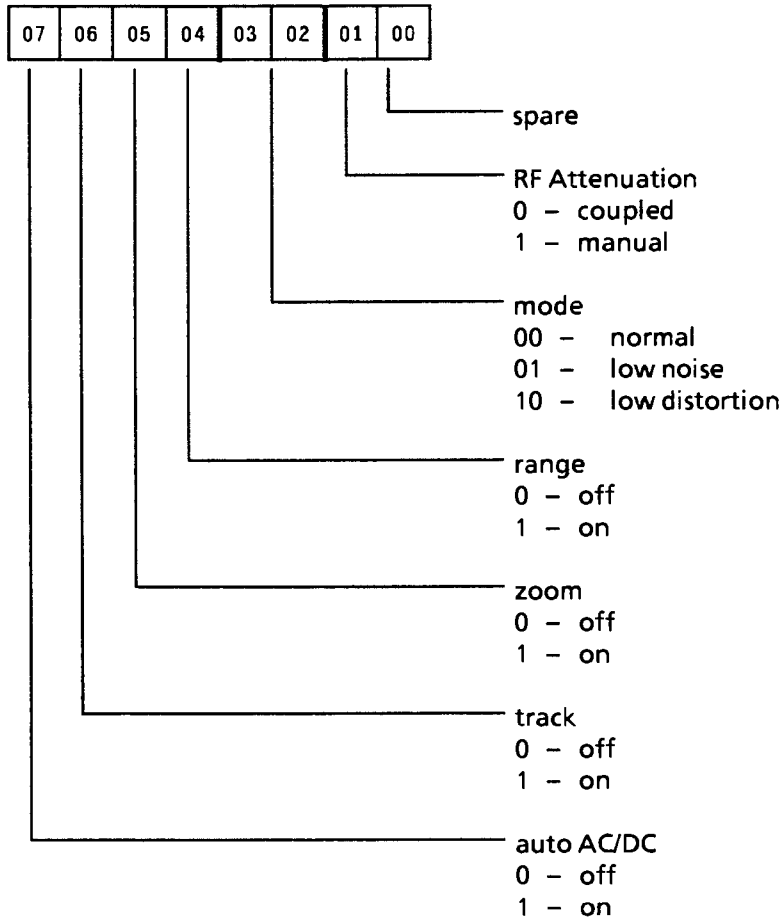

1827: unsigned char mode [7] AC/DC

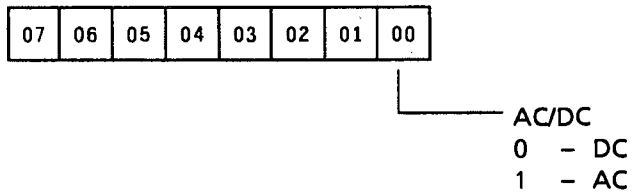

1828: unsigned char mode [8] Span

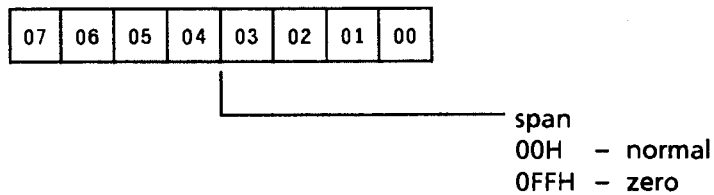

1829: unsigned char mode [9] CF-Step

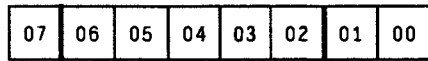

stepsize
00 - 0.1 * Span
01 - 0.5 * Span
10 - x MHz
11 - Centerfreq.

Bit Display
0 - off
1 - on

1830: char span_rbw [6] ratio Span/Resbw

1836: char rbw_vbw [6] ratio Resbw / Vidbw * 1000

1842: unsigned char ifcount resolution IF-Counter

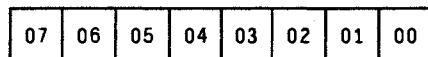

resolution
0 - 10 kHz
1 - 1 kHz
2 - 100 Hz
3 - 10 Hz
4 - 1 Hz
5 - 0.1 Hz

1843: unsigned char spfunc [0] Detector

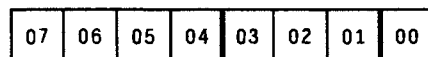

Detector
0 off (coupled)
1 on

Detector type
000 - Peak +
001 - Peak-
010 - Sample
011 - ---
100 - Auto Peak

spare

1844: unsigned char spfunc [1] Transducer Table

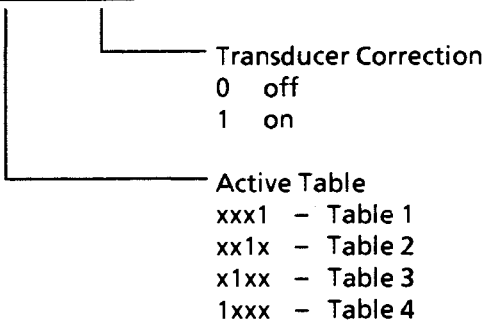
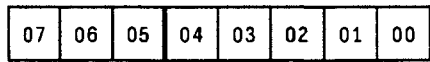

1845: unsigned char spfunc [2]

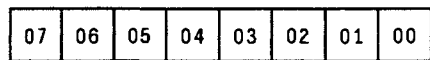

1846: unsigned char spfunc [3]

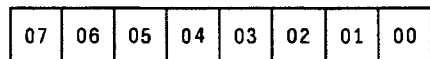

1847: unsigned char spfunc [4] Reference

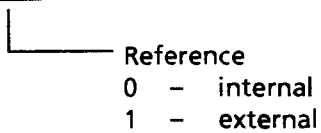
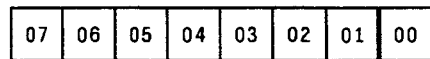

1848: unsigned char spfunc [5] Mixer

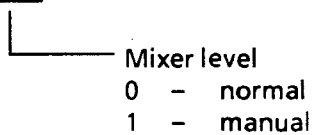
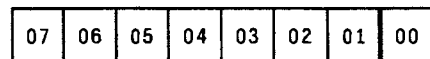

1849: unsigned char spfunc [6]

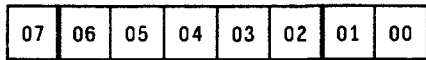

- Active window
 - 00 - ---
 - 01 - Window 1
 - 10 - Window 2
 - 11 - ---
- Split Screen
 - 0 - off
 - 1 - on

1850: unsigned char spfunc [7]

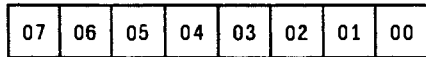

1851: unsigned char spfunc [8] 75 Ohm

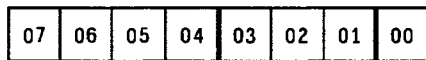

- Matching
 - 0 - off
 - 1 - on
- FSA-In/ TG Out
 - 000 - RAM
 - 001 - RAZ

1852: unsigned char tgmode

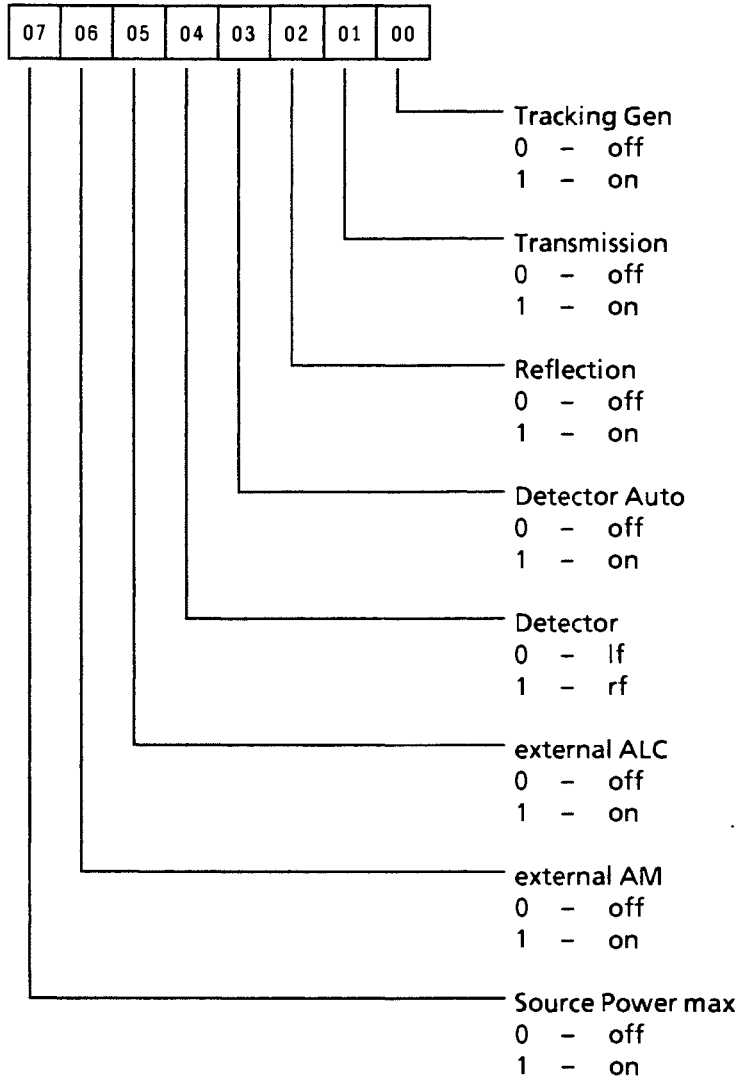

1853: int avg_num

Average - Samples

- 0 Continuous Sample Mode
- 1 ...32767 Real Average Mode
- Single Sweep: Stop Sweep
- after avg_num Samples
- (*OPC on IEEE Bus)

1855: int bw_kfact Correction Level * 0.01 dB (Unit/MHz)

1857: char bit_resol [6] Bit Display Resolution * 1 ns

1863: unsigned char spare [19]

1882: char tgfreq [6] Frequency Offset
Tracking Generator * 1 Hz

1888: unsigned char spare

1889: unsigned char trace

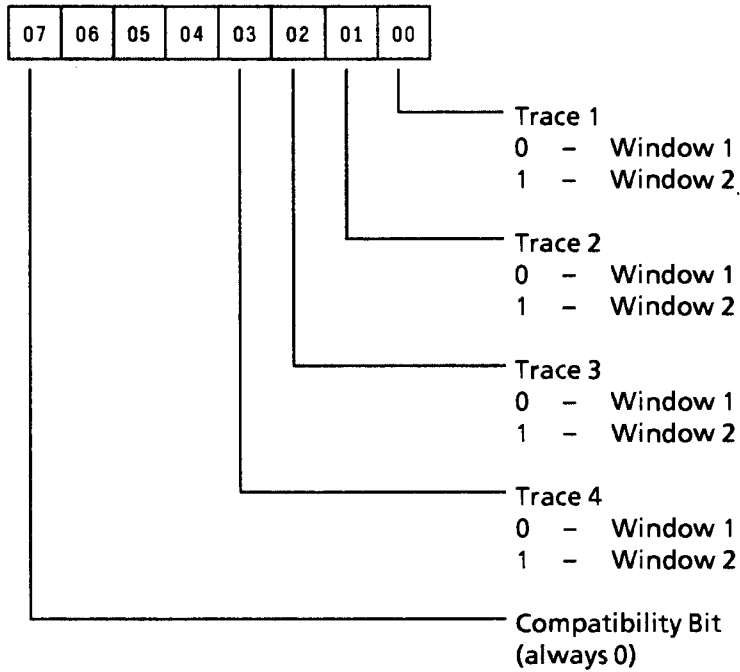

/*----- Span Data -----*/

1890:	char offset [6]	Frequency Offset	* 1Hz
1896:	char center [6]	Center Frequency	* 1Hz
1902:	char span [6]	Span	* 1Hz
1908:	char cstep [6]	Center Freq. Stepsize	* 1Hz
1914:	char start [6]	Start Frequency	* 1Hz
1920:	char stop [6]	Stop Frequency	* 1Hz
1926:	long swptim	Sweeptime	* 100μsec
1930:	char resbw [6]	Resolution Bandwidth	* 0. 1Hz

1936: unsigned char vidbw

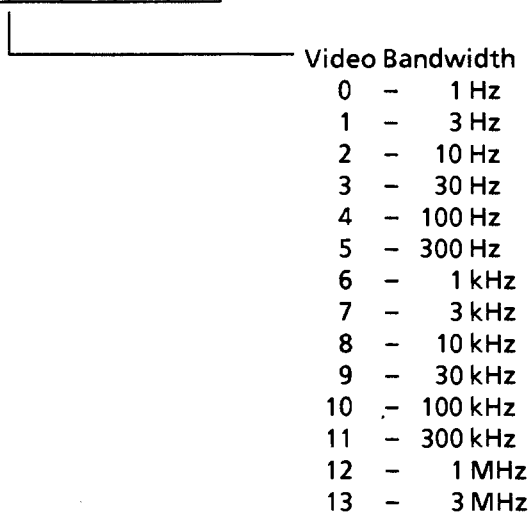
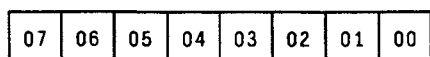

1937:	char center1 [6]	log Sweep
1943:	char span1 [6]	log Sweep
1949:	char [6]	spare
1955:	char start1 [6]	log Sweep
1961:	char stop1 [6]	log Sweep
1967:	char [113]	spare

2080: unsigned int rxmode

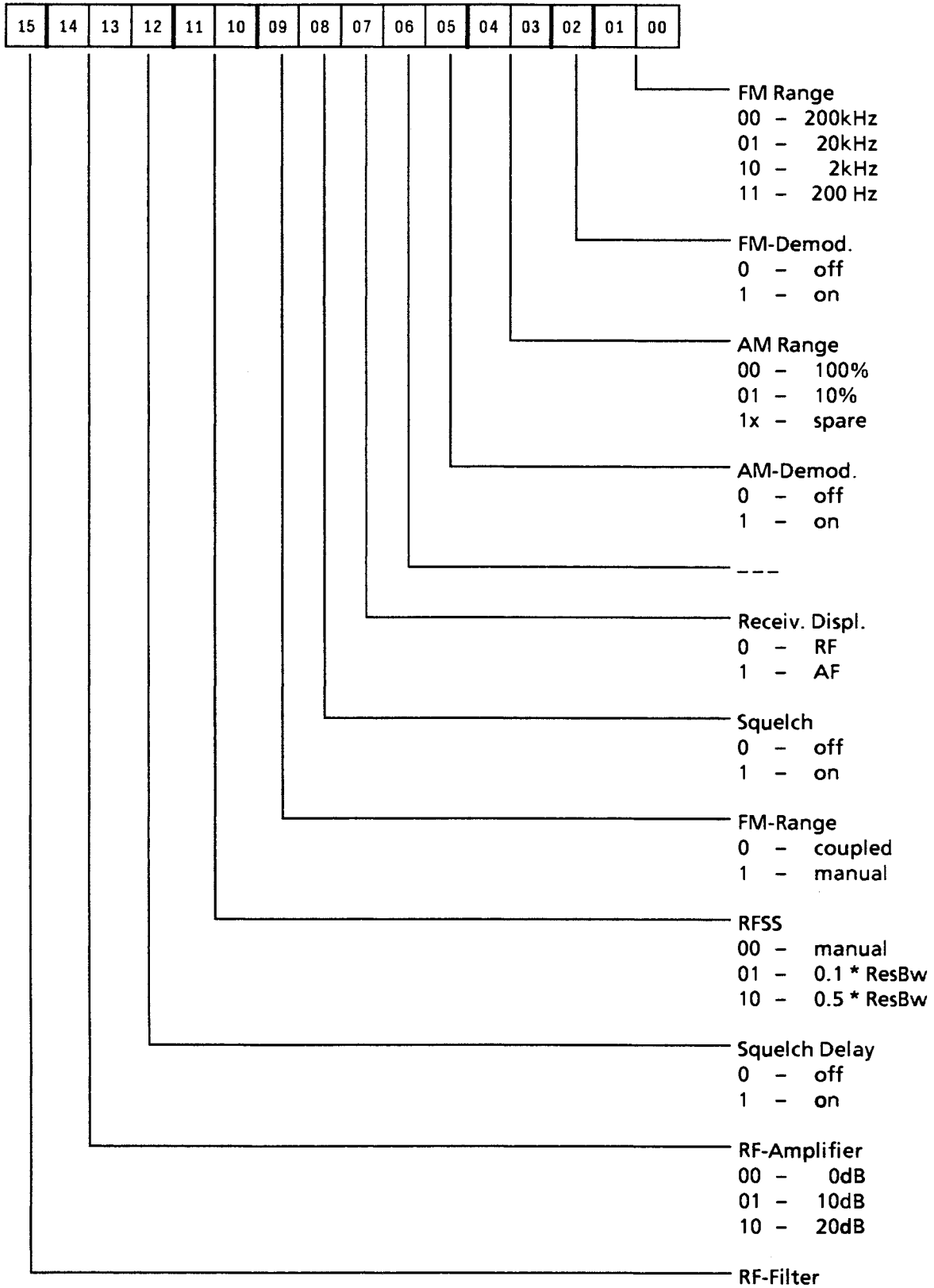

2082: int volume
 2084: int squelch
 2086: int trigger

 2088: char span_rf [6]

 2094: char center_rf [6]
 2100: char center_af [6]

 2106: char cfss [6]
 2112: char rfss [6]

 2118: int reference_rf [4]
 2126: int reference_af [4]

 2134: char resbw_rf [6]
 2140: char resbw_af [6]

 2146: unsigned char vidbw_rf
 2147: unsigned char vidbw_af

 2148: unsigned long swptim_rf
 2152: unsigned long swptim_af

 2156: unsigned char rfatt_rf
 2157: unsigned char rfatt_af

 2158: unsigned char mode5_rf

 2159: unsigned char mode6_rf
 2160: unsigned char mode6_af

 2161: unsigned char gain_rf

 2162: unsigned char mode9_rf
 2163: unsigned char mode9_af

 2164: unsigned char mode4_rf
 2165: unsigned char mode4_af

 2166: unsigned int trigger_rf
 2168: unsigned int trigger_af

 2170: unsigned int sq_delay
 2172: unsigned char tline_rf

 2173: unsigned char [17] spare
 .
 .
 .
 2190

2.5 Interfaces

2.5.1 IEC Bus Interface

2.5.1.1 Interface Characteristics

The analyzer can be remote-controlled by an external controller via the IEC/IEEE-bus interface.

- 8-bit parallel data bus
- bidirectional data transfer
- three wire handshake
- high data transmission rate of up to 350 Kbyte/sec.
- up to 15 devices may be attached
- connector cables up to 20 m long

2.5.1.2 Pin Assignment and Signal Designations

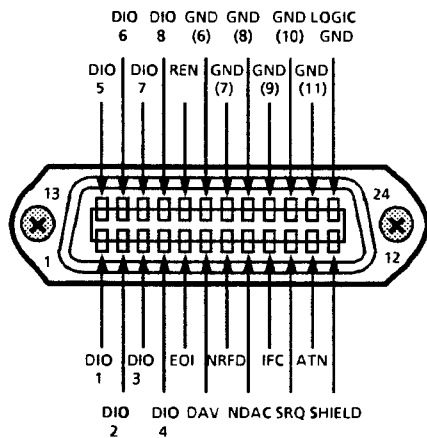

Fig 2-9 Pin assignment for the IEC bus

The IEC bus interface is a 24-pin Amphenol connector. The pin assignment is shown in Table 2-14.

The lines may be subdivided into three groups: the data bus (8 lines), the handshake bus (3 lines: DAV, NRFD and NDAC) and the management bus (5 lines: ATN, EOI, IFC, REN, SRQ).

The lines are addressed using negative logic i.e. message is true (= 1) in Low state and false (= 0) in High state. Since the handshake and management lines are implemented with open collector output, connection of several devices in parallel via the bus results in a wired OR connection of the signals.

Table 2-14 Pin assignment according to IEC625/1(IEEE488-1)

Pin	Signal name	Function															
1	DIO1 (LSB)	Data bus, transmission line for data, addresses and commands															
2	DIO2																
3	DIO3																
4	DIO4																
13	DIO5																
14	DIO6																
15	DIO7																
16	DIO8(MSB)																
6	DAV	"Data valid" Talker acknowledges data put on bus as valid by pulling DAV = L.															
7	NRFD	"Not ready for data" Listener signals not ready to receive data by pulling NRFD = L.															
8	NDAC	"Not data accepted" Listener signals data not yet received by pulling NDAC = L.															
5	EOI	"End or identify" This signal has two different meanings in respect to the data on the bus depending on the value of ATN: <table border="1" style="margin-left: 20px;"> <thead> <tr> <th>ATN</th> <th>EOI</th> <th>Meaning of DIO</th> </tr> </thead> <tbody> <tr> <td>0</td> <td>0</td> <td>data byte</td> </tr> <tr> <td>1</td> <td>0</td> <td>address or command</td> </tr> <tr> <td>0</td> <td>1</td> <td>END (last data byte in a block)</td> </tr> <tr> <td>1</td> <td>1</td> <td>IDENTIFY (request for identify after a call)</td> </tr> </tbody> </table>	ATN	EOI	Meaning of DIO	0	0	data byte	1	0	address or command	0	1	END (last data byte in a block)	1	1	IDENTIFY (request for identify after a call)
ATN	EOI	Meaning of DIO															
0	0	data byte															
1	0	address or command															
0	1	END (last data byte in a block)															
1	1	IDENTIFY (request for identify after a call)															
9	IFC	"Interface Clear" The system controller resets the remote control of all attached device to ground state by pulling IFC = L (pulse length approx. 100 μ s)															
10	SRQ	"Service request" Any device equipped with this function can request attention from the controller via this line (SRQ = L).															
11	ATN	"Attention" The controller pulls ATN = L while sending addresses or commands over the data bus. Data are transmitted when ATN = H.															
17	REN	"Remote enable" The controller switches the attached devices to remote control, locking manual control by pulling REN = L.															
12, 18, 19, 20, 21, 22, 23, 24	Shield GND, GND, GND, GND, GND, GND, Logic GND																

2.5.2 Parallel Printer Interface (Centronics)

2.5.2.1 Interface Characteristics

The Centronics interface is used to output texts and graphics to matrix printers. The interface has the following characteristics:

- 8-bit parallel unidirectional data transfer
- handshake using three signal lines
- additional lines for printer messages

Transmission of data and control signals is carried out with a TTL level in positive logic. The output levels are:

"0" = Low < +0.4 V

"1" = High > +2 V

The maximum line length is 6 m.

2.5.2.2 Pin Assignment and Signal Designations

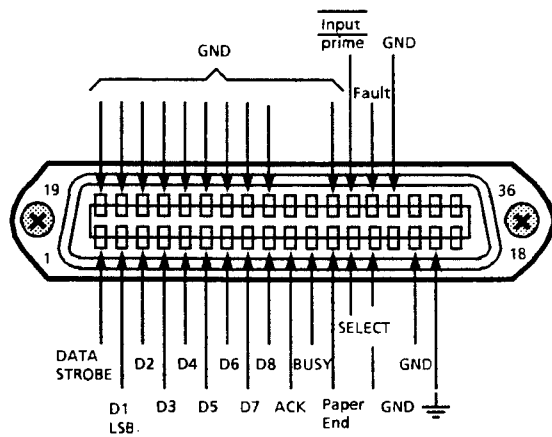

Fig. 2-10 Pin assignment for centronics interface

Table 2-15

Pin	I/O	Signal	Function
1	O	/STROBE	Sync signal for data accept
2	O	DATA1 (LSB)	Data bus (transmit line for 8 bits in parallel)
3	O	DATA2	
4	O	DATA3	
5	O	DATA4	
6	O	DATA5	
7	O	DATA6	
8	O	DATA7	
9	O	DATA8 (MSB)	
10	I	/ACK	Printer set /ACK = LOW to show ready to receive next character
11	I	BUSY	Printer set BUSY = HIGH to signal not ready to receive further characters (e.g. input buffer is full)
12	I	PAPER END	Set to High when out of paper (or ink). Locks out transmission of further characters
13	I	SELECT	Show printer status: H = printer is on-line L = printer is off-line (fault or test)
31	O	/INIT /INPUT PRIME	Resets printer to initial status (equivalent to a reset)
32	I	/FAULT	Indicates error state of printer, e.g. offline, paper end (dependent on printer type)
18		+ 5 V	From printer power supply for interface circuits
14, 16, 19...27, 30, 33, 17		GND GND GND Shield	

/ = Signal inverted (active Low)

2.5.2.3 Signal Timing Sequence

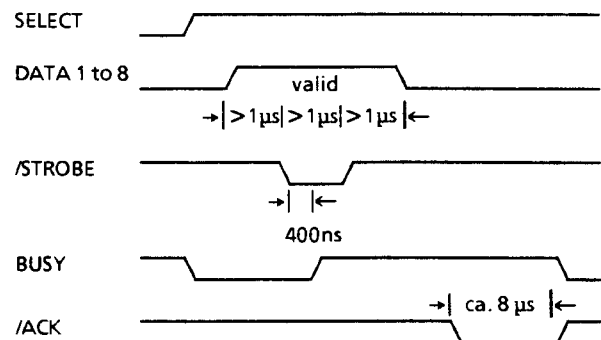

2.5.3 Serial Interface

The serial interface is used for data communication between peripheral devices, e.g. MODEMs, terminals, line printers and paper tapes, as well as for the connection to a computer network. This interface is supported by the controller function FS-K1.

2.5.3.1 Interface Characteristics

- Serial data transfer
- Bidirectional data transfer via two separate lines
- Data transfer rate programmable from 50 to 19200 baud
- High signal-to-noise ratio with ± 11 V level
- Lines of several 100 m lengths possible
- Operation possible with or without hand-shake

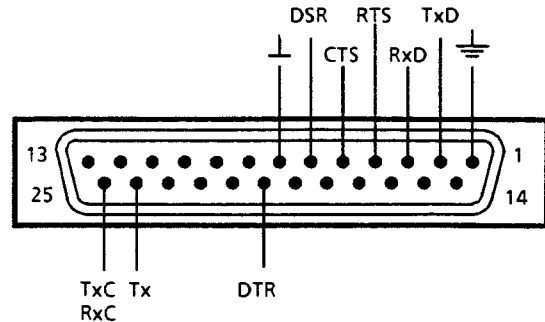

Fig. 2-11 Pin assignment for the RS-232-C-interface

2.5.3.2 Interface Data

	V.24/V.28 RS-232-C
Line length max. Transmission rate max.	15 m 20 kbaud
Driver: Type Voltage (idle) Output voltage with load of	asymm. < ± 25 V ± 5 to 15 V 3 to 7 Ω
Receivers: Max. number Type Input voltage max. Input voltage min. Input resistance	1 asymm. ± 25 V ± 3 V 3 to 7 Ω

Table 2-16 Pin assignment for RS-232-C interface

Pin	I/O	Signal name	Function
1	-	Shield	Shielded ground
7	-	Ground	Signal ground
2	O	TxD Transmit Data	Transmitted data
3	I	RxD Receive Data	Received data
4	O	RTS Request to send	Spectrum Analyzer signals ready to receive data. Transmitting section of external device is activated.
5	I	CTS Clear to send	Data transmitting section of Spectrum Analyzer is activated.
6	I	DSR Data set ready	Signals to Spectrum Analyzer that external devices are attached and ready for operation.
20	O	DTR Data Terminal ready	Spectrum Analyzer signals ready for operation.
23	O	Tx	Transmitter signal element timing for external device
24	I	TxC RxC	Transmitter/receiver signal element timing from external device

2.5.3.3 Pin Assignment and Signal Designations

For serial operation, the 25-pin connector as shown in fig. 2-11 is used. The connector RS 232 of the spectrum analyzer is wired up in accordance with the CCITT standard V.24/V.28 for a DTE.

Note: The DCD line (Data Carrier Detected) provided with pin 8 according to the standard is not switched and can automatically be operated with CTS via jumpers X37 and X30 on the I/O Board of the display unit.

2.5.4 External Floppy Interface

The floppy disk station can be connected to the EXT. FLOPPY socket at the rear of the analyzer (see Fig. 2-12).

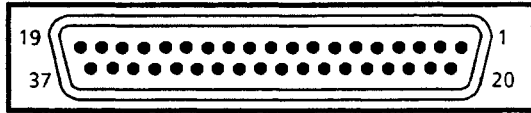

External socket
(connector solder side)

Fig. 2-12 37-pin Cannon connector

2.5.4.1 Pin Assignment and Signal Description

Table 2-17

Pin	I/O	Signal name	Function
21	O	/READY	Signals device ready (power on, disk inserted and rotating)
22	I	/Side Sel	Selects one of the two heads Low = Side 1 Low = Side 2
23	O	/R-Data	Carries raw read data. Signals a Low pulse for each change in magnetization.
24	O	/W Prot	Determines if floppy disk may be written to. Low locks out the write signal. The 5 1/4" floppy disk is protected when the write protect notch is covered.
25	O	/Track 0	Signals first track. Used to determine position after power-on.
26	I	W-Gate	Selects signals for Write Data and Read Data. High = Read Data active Low = Write Data active Use of a write protected diskette internally prevents writing.

Pin	I/O	Signal name	Function
27	I	/W-Data	Carries data to be written. A switch from High to Low causes an impulse at the write head. The signal works only during Write Gate = Low.
28	I	/Step	Moves the head one track in the direction indicated by /Direction Select for each Low impulse. When /Write Gate is Low no step is possible.
29	I	/Dir	Defines the direction of movement for the head. High = toward rim Low = toward hub
30	I	/Motor on	Turns on the motor of the disk drive. A jumper in the drive allows the select signal to be used.
31	I	/D-Sel 2	n.c.
32	I	/D-Sel 1	(external, "B")
33	I	/D-Sel 0	(external, "A") Allows selection of the different drives if more than one is installed.
34	O	/Index	Indicates the start of track with a Low impulse for each rotation.
36	I	/Head Load	Lowers the head to the floppy disk. The drive must also be selected and /Ready = Low. Also turns on the access LED.
20.1 35.2 37			n. c.
3... 19		GND	ground

2.5.5 External Video Interface

The analyzer allows connection of an external color monitor. For this purpose five BNC sockets are available on the rear of the unit. The socket COMPOSITE VIDEO may also be connected to a video printer. Please note that the analyzer uses a line frequency of approx. 30 kHz.

Connection is carried out using a 70- Ω coaxial cable. For connector lengths of under 2 m no visible degradation of display quality is noticeable when 50- Ω lines are used. A special connecting cable with a 9 pin socket is available for IBM-PC/AT compatible monitors with a line frequency of approx. 30 kHz under the designation:

Video Cable R-G-B-SYNC EZ-1 837.1514.02

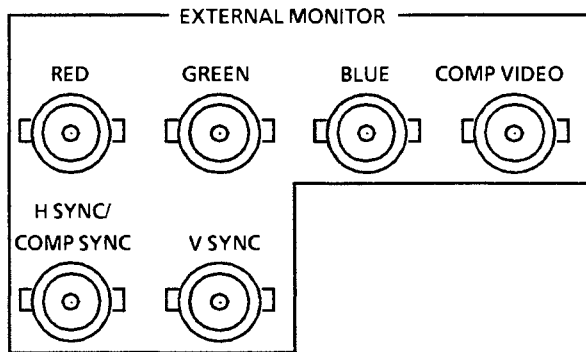

2.5.5.1 Interface Description

- Internal resistance 75 Ω
- Composite video signal (BAS signal monochrome) as well as
- Composite sync. and red, green, blue
- Field frequency of 50 Hz, non-interlaced
- Line frequency 29.41 kHz
- Pixel frequency (bandwidth) 40 MHz
- Color monitor:
 - Four BNC sockets
 - Video signal RGB 0.3 to 1 V into 75 Ω (positive)
 - Composite sync 0 to 2 V into 75 Ω (negative)

2.5.5.2 Signal Timing Sequence

Figure 2-13 shows the composite video timing diagram within a picture and within a line.

Within the timeframe of a picture (20 msec.) 512 lines at 34 μ sec. each are written. Approx. 2.6 msec. are provided for picture return together with the field sync pulse.

Each line (of 34 μ sec.) is composed of 1024 pixels of 25 nsec. each. Approx. 8.4 μ sec. are provided for the line return and the line sync pulse.

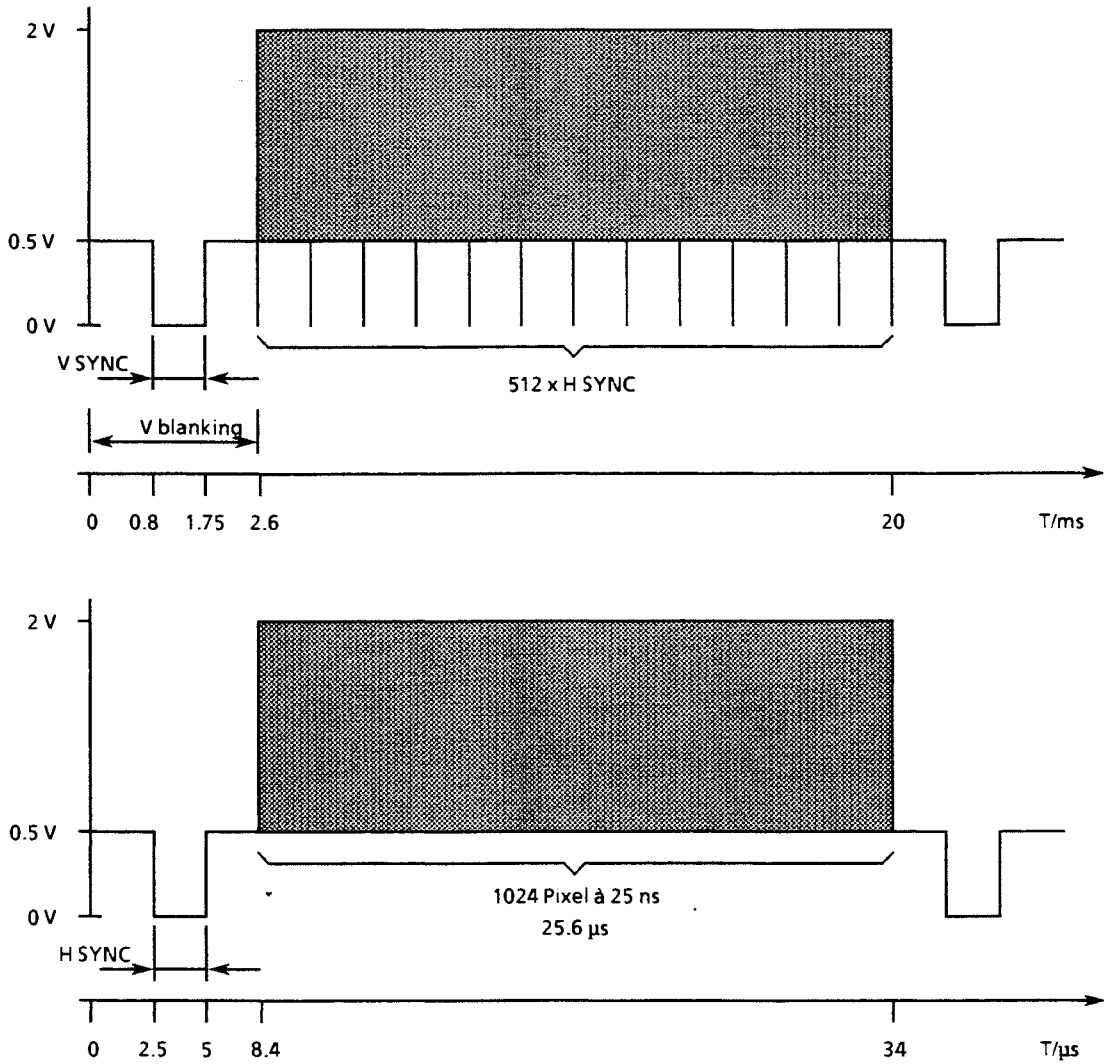

Fig. 2-13 Time frame of COMP.VIDEO, picture (above) and line (below)

The connectors R, G, and B show the same timeframe as the signal COMPOSITE VIDEO. However, the sync pulses of 0 V are not present. The voltage is 0.3 to 1 V at full brightness.

Figure 2-14 shows the signal SYNC for a screen frame. It is composed of 560 line sync pulses and one field sync pulse.

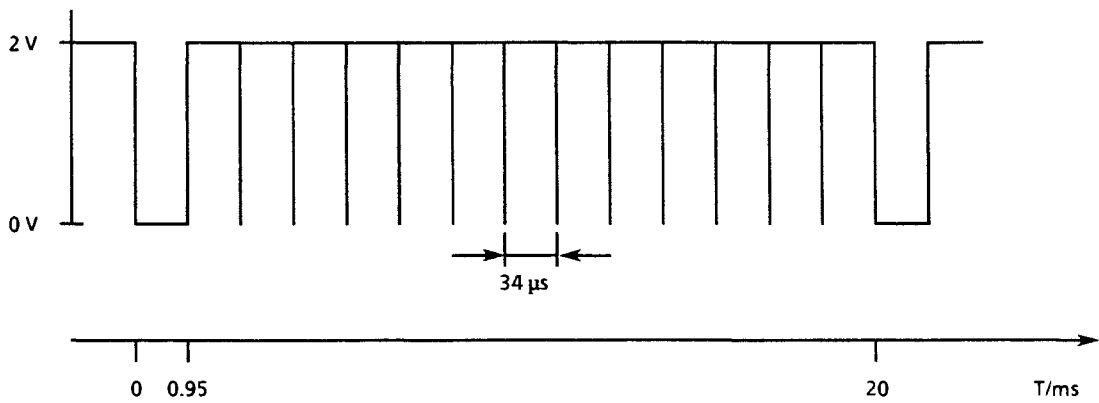

Fig. 2-14 Timeframe synchronization

2.5.6 Keyboard Interface

2.5.6.1 Interface Characteristics

The interface has the following specifications:

- serial data transfer with 2400 baud
- level 0 to 5 V (reduced RS-232 level)
- data format: start bit + 8 data bits + stop bit

2.5.6.2 Connector

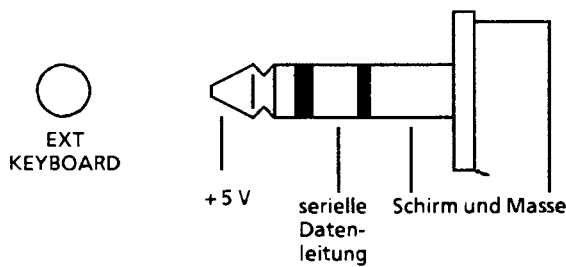

Fig. 2-15 Connection of keyboard

Connector **24** on the front panel of the display unit is switched in parallel with connector **60** on the rear panel. The two connectors can be optionally used.

2.5.6.3 Signal Timing Sequence

The interface functions with positive logic i.e. inverted RS-232 signal. ON state corresponds to + 5 V and OFF state corresponds to 0 V. With the standard speed of 2400 baud, a cycle corresponds to approx. 416 μ sec. Fig. 2-16 shows the code <CR> (= 0D hex) as an example. The stop bits are not visible since the idle state level also is + 5 V.

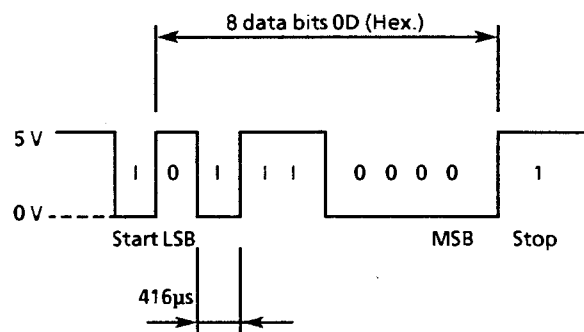

Fig. 2-16 Signal timeframe chart

2.5.7 User Port

2.5.7.1. Interface Characteristics

These interfaces allow control of a test adapter or test items as well as input of external TTL signals.

This interface also contains a supply voltage of +5V for external circuits. Control of the port lines is supported via the SETUP menu of the analyzer, or may be realized using a corresponding program on the analyzer. The interface does not allow interrupts but must be queried by the program.

Control using BASIC instructions is carried out via IEC bus commands.

2.5.7.2 Pin Assignment and Signal Designations

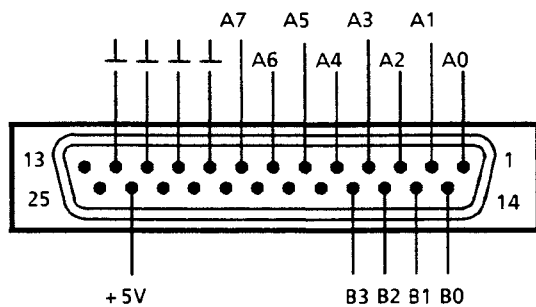

Fig. 2-17 25-pin Cannon connector

Table 2-18

Pin	Signal	Function
1	A0 (LSB)	I/O-Port A
2	A1	
3	A2	
4	A3	
5	A4	
6	A5	
7	A6	
8	A7 (MSB)	
9	GND	n. c.
10	GND	
11	GND	
12	GND	
13		n. c.
14	B0 (LSB)	I/O-Port B
15	B1	
16	B2	
17	B3 (MSB)	
18		n. c.
19		
20		
21		
22		n. c.
23		n. c.
24	+ 5 V	Load to max. 500 mA
25		n. c.

2.5.7.3 Electrical Characteristics

The user port is controlled by a programmable interface IC. The IC specifications are given in Table 2-19.

Table 2-19 Electrical characteristics of 82C55

Parameter	Conditions	Value
V _{IH} High-level input voltage		min 2.2V
V _{IL} Low-level input voltage		max 0.8V
V _{OH} High-level output voltage	I _{OH} = -400μA	min 3.3V
V _{OL} Low-level output voltage	I _{OL} = 2.5mA	max 0.4V

2.5.8 PROBE CODE

2.5.8.1 Interface Characteristics

This interface provides for the DC supply and takes into account the specific characteristics of transducers connected in series.

2.5.8.2 Pin Assignment and Signal Designations

Pin assignment of the 12-pin Tuchel connector
(Front view):

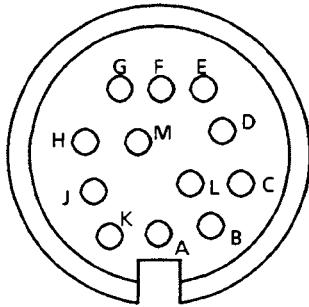

Pin	Signal
A	Ground
B	+ 10 V (max. 50 mA)
C	$\mu\text{V/m}$ (electr. field strength)
D	μA
E	10 dB
F	20 dB
G	40 dB
H	80 dB
J	$\mu\text{A/m}$ (magnet. field strength)
K	-10 V (max. 50 mA)
M	Reversed sign of factor

3 Performance Test

This section presents short tests for checking the main rated specifications. Approximately 90 % of the guaranteed values are checked.

If a 100 % test is required, proceed as in Section 4.4 (Testing of Complete Instrument).

It is recommended to perform the described tests once a year (the internal crystal oscillator is subject to natural aging) in order to comply with the guaranteed specifications for the frequency accuracy. Further checks described in Section 3.4 are also advisable.

The measured values obtained from the annual tests can be entered in a copy of the Performance Test Report (Section 3.3) which enables a complete overview of the required specifications.

3.1 Required Measuring Equipment and Accessories

Item	<ul style="list-style-type: none"> ◦ Designation, required specifications ● Recommended R&S equipment 	Type	Order No.	Use described in section:
1	<ul style="list-style-type: none"> ◦ Frequency counter Frequency 10 MHz Inherent error $< 1 \times 10^{-8}$ Input impedance 50 Ω Max. input voltage 5 V Ext. reference input 5/10 MHz 			3.2.1.1
2	<ul style="list-style-type: none"> ◦ Frequency standard Frequency 5 MHz Inherent error $< 1 \times 10^{-9}$ Output impedance 50 Ω Output voltage > 0.1 V ● Rubidium frequency standard ● Caesium frequency standard 	<ul style="list-style-type: none"> XSRM XSC 	<ul style="list-style-type: none"> 238.4011.02 299.4011.02 	<ul style="list-style-type: none"> 3.2.1.1 3.2.1.3 3.2.2.1 3.2.2.2
3	<ul style="list-style-type: none"> ◦ RF generators Frequency range 100 MHz to 18 GHz Output impedance 50 Ω Output level -40 to +30 dBm (generator and power amplifier if required) ● Sweep generator ● Synthesized signal generator 	<ul style="list-style-type: none"> SWM SMGU 	<ul style="list-style-type: none"> 814.7016.05 819.0010.52 	<ul style="list-style-type: none"> 3.2.1.2 3.2.1.3 3.2.2.1 3.2.2.2 3.2.2.3 3.2.2.7 3.2.2.9 3.2.3.2.3 3.2.3.2.4 3.2.3.2.5 3.2.3.2.6

Item	<ul style="list-style-type: none"> ◦ Designation, required specifications ● Recommended R&S equipment 	Type	Order No.	Use described in section:
4	<ul style="list-style-type: none"> ◦ RF power meter with precision power sensor Frequency range 10 MHz to 5 GHz Power range -30 dBm to 0 dBm Accuracy <0.1 dB ● RF power meter with precision power sensor 	NRV NRV-Z2 URV5-Z4	828.2511.02 828.3218.02 395.1619.55	3.2.2.1 3.2.2.2 3.2.2.3 3.2.2.7 3.2.2.9
5	<ul style="list-style-type: none"> ◦ Power divider 2 x 50 Ω Transmission loss <7 dB Level difference at outputs <0.1 dB 			3.2.2.1 3.2.2.2 3.2.2.3 3.2.2.5 3.2.2.6 3.2.2.8
6	<ul style="list-style-type: none"> ◦ Precision calibration set Attenuation range 0 to 100 dB Attenuation steps 0.1 dB Maximum power 1 W ● Precision attenuator set f <2.7 GHz 	RSP	831.3515.02	3.2.2.5 3.2.2.6 3.2.2.7 3.2.2.8 3.2.2.9
7	<ul style="list-style-type: none"> ◦ VSWR bridge Impedance 50 Ω Frequency range 10 MHz to 5 GHz Directivity >40 dB 			3.2.2.9
8	<ul style="list-style-type: none"> ◦ Termination 50 Ω Connector: N male Reflection coefficient <10 % Frequency range 0 to 5 GHz 			3.2.2.10 3.2.2.11 3.2.3.1.1 3.2.3.1.2 3.2.3.1.3
9	<ul style="list-style-type: none"> ◦ Various lowpass/bandpass filters Attenuation for f > 2 × f_g: >70 dB Impedance 50 Ω 			3.2.3.2.3 3.2.3.2.4 3.2.3.2.5
10	<ul style="list-style-type: none"> ◦ Power adder Frequency range 10 MHz to 5 GHz Impedance 50 Ω Decoupling >25 dB 			3.2.3.2.4
11	<ul style="list-style-type: none"> ◦ Microwave analyzer Frequency range 5 to 11 GHz Impedance 50 Ω Sensitivity <-110 dBm 			3.2.3.2.7

3.2 Checking the Rated Specifications

Checking the rated specifications provides information on the condition of the instrument and covers approx. 90 % of the guaranteed values. These tests can be specifically supplemented according to requirements.

Proceed according to Section 4.4 (Testing Complete Instrument) if a 100 % test is required.

The rated specifications can only be correctly checked if the following tests are carried out and the results prove to be satisfactory.

Power supply: four green LEDs and one yellow LED at the rear of the instrument light up.

Switch-on test: no error message.

Test : checking of all LEDs, keys, supply voltages, calibration values without errors.

Set the instrument to internal reference (see Operating Manual, section SET UP). If deviations from normal operation are not expected, the following setting applies:

RF attenuation: ≥ 10 dB

Resolution bandwidth, video bandwidth, sweep time in "Coupled mode" matched to type of signal.

3.2.1 Frequency Accuracy

3.2.1.1 Internal Reference Frequency

The accuracy of the internal reference frequency largely depends on the temperature inside the instrument and the operating time of the oscillator. A reference value for the frequency error is 1×10^{-7} , although the oscillator can be set to $< 1 \times 10^{-8}$.

Essential for measurement:

The instrument must be operated for at least one hour at an ambient temperature of $25 \pm 5^\circ\text{C}$. (The aging of the internal reference can only be determined after a period of at least 30 days.) The instrument operates with its own (internal) reference source.

Required measuring equipment:

Frequency counter

Resolution 10^{-8}

Frequency 10 MHz

Frequency error $< 1 \times 10^{-8}$

An external frequency standard (rubidium or caesium) may have to be used for the counter.

Test setup for 3.2.1.1:

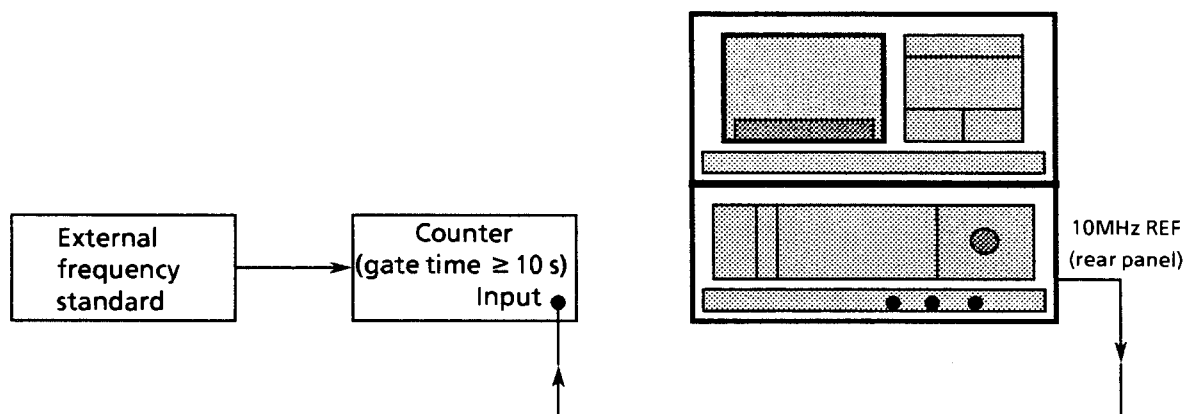

3.2.1.2 Frequency Accuracy According to Data Sheet

The frequency accuracy of the instrument depends on

- the internal reference frequency (Section 3.2.1.1)
- the span setting (>5 MHz, ≤ 5 MHz)
- the centre frequency accuracy of the IF filter.

Since the instrument carries out measurements in the calibrated state, deviations of the IF filter centre frequency are compensated for as a result of calibration. The residual error is much smaller than the span and can therefore be ignored.

Required measuring equipment:

Generator (synthesizer)
 Frequency error $< 10^{-8}$
 Frequency range 100 Hz to 5 GHz

An external frequency standard (rubidium or caesium) may have to be used for the generator.

Span setting 5200 MHz (full span, coupled mode):

At each frequency, the deviation must be less than

$$\Delta = 8 \times 10^{-3} \times \text{span}$$

The expression applies to all spans larger than 5 MHz. If it is not satisfied, proceed as in Section 4.4.16.

Span setting ≤ 5 MHz (coupled mode):

At each frequency, the deviation must be less than

$$\Delta = 2.5 \times 10^{-3} \times \text{span} \pm \text{RBW} \pm f_c \times \text{R. A.}$$

The expression applies to all spans between 100 Hz and 5 MHz. If it is not satisfied, proceed as in Section 4.4.16.

(RBW = Resolution bandwidth
 f_c = Centre frequency
 R. A. = Reference frequency error)

Test setup for 3.2.1.2:

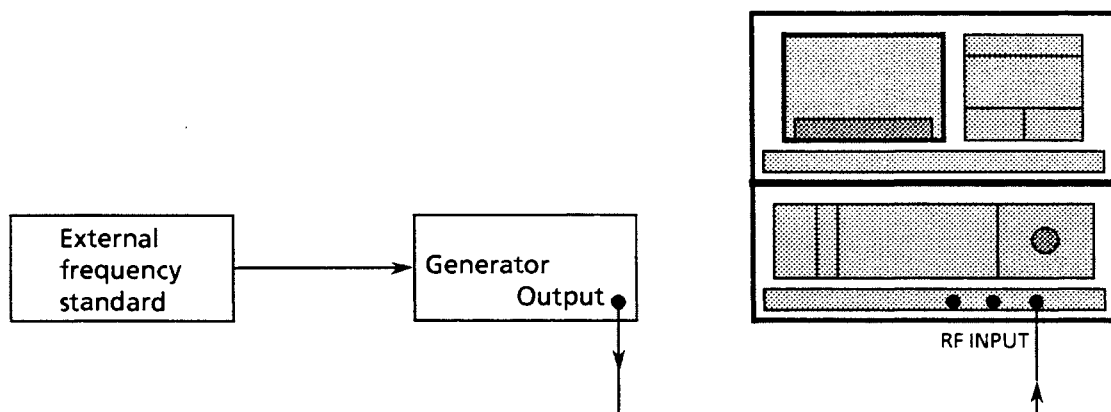

3.2.1.3 Span Accuracy

The span accuracy is independent of the absolute frequency and 5×10^{-3} in coupled mode. The stop and start frequencies are determined using an external generator in monochrome mode (graticule colour = trace colour = marker colour) and the difference generated between these two values (= span).

3.2.1.4 External Reference

Set the instrument to the external reference in the SETUP menu. Deviations in the external reference of 1×10^{-6} (corresponding to ± 10 Hz) must not lead to error messages. Check the level range according to the data sheet.

3.2.2 Amplitude Accuracy

3.2.2.1 Calibration Output 100 MHz

The level accuracy (= amplitude accuracy) of the instrument depends directly on the level accuracy of the calibration signal. Since the internal calibration source is also used in a direct method (see in the following), its amplitude accuracy must be checked twice (direct and indirect methods).

The power meter largely determines the accuracy in both cases (see test setup) and must therefore be calibrated exactly (correction curve).

Analyzer setting:

Linear display
RF attenuation 10 dB
Reference level -19.0 dBm.

Interpretation of the result depends on whether the power meter used to calibrate the device was used according to Section 4.3.1 or not.

Tolerance analysis: (see standard IEC 714, Expression of the properties of spectrum analyzers):

- Power meter used for calibration:

tolerance = permissible tolerance according to data sheet minus tolerance of measuring instrument
- Power meter *not* used for calibration:

tolerance = permissible tolerance according to data sheet plus tolerance of measuring instrument

Direct method:

The sensor is connected to CAL OUTPUT.

Indirect method:

The analyzer is tuned to 100 MHz and calibrated briefly. The generator applies the same power to the sensor and the analyzer input via the power divider.

(Note: Harmonics suppression of generator >40 dB)

The tolerances of the power divider must be incorporated in the tolerance analysis.

Vary the generator level until the analyzer indicates -20 ± 0.5 dBm.

The difference between the analyzer display and the power meter display is the inherent error of the internal calibration.

As a result of the calibration procedure and the finite inherent accuracy of the calibration equipment, doubling of the tolerance according to the tolerance analysis with an independent power meter (not used for the calibration) is almost unavoidable.

Test setup for 3.2.2.1:

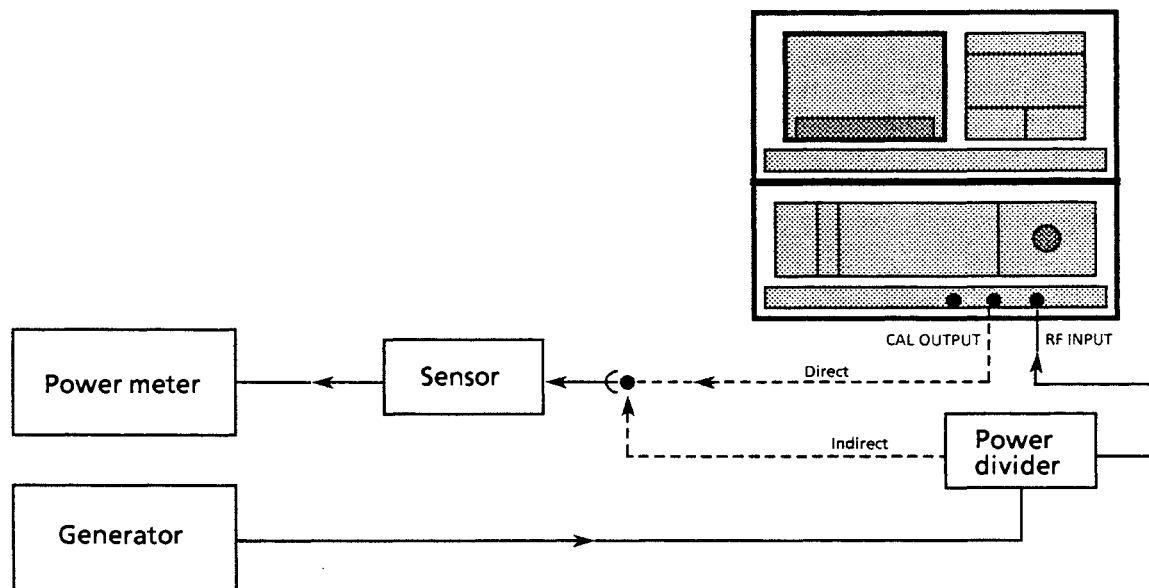

3.2.2.2 RF Frequency Response with Fixed (10 dB) RF Attenuation

The procedure is the same as in Section 3.2.2.1 (indirect method) except that the frequency of the analyzer and generator is varied between 100 Hz and 5 GHz. The correction coefficients (especially of the power sensor and the power divider) must also be taken into account.

As far as the tolerance is concerned, points discussed in Section 3.2.2.1 apply. The frequency response in the complete frequency range may be 1.0 dB (reference frequency 100 MHz). If the measuring equipment recommended in Section 3.1 is used for the calibration, a tolerance of only ± 0.78 dB is permissible (with tolerance NRV).

Otherwise, the permissible tolerance is increased to ± 1.22 dB.

The maximum error must not exceed the following values:

f < 2 GHz	
Error per 5-dB step	< ± 0.2 dB
Total error	< $\pm (0.3 + 1.3 \% \text{ of attenuation value})$ dB
Max.	1 dB

f > 2 GHz	
Error per 5-dB step	< ± 0.5 dB
Total error	< $\pm (0.5 + 2.5 \% \text{ of attenuation value})$ dB
Max.	2 dB

3.2.2.3 RF Frequency Response with RF Attenuation > 10 dB

The procedure is the same as in Section 3.2.2, the reference values according to Section 3.2.2.2.

Increase the RF level of the generator in 10-dB steps. The maximum power of the divider or the RF attenuation switch ($1 \text{ W} \hat{=} +30 \text{ dBm}$) must not be exceeded.

3.2.2.4 Level Display Linearity in Logarithmic Level Ranges

The procedure is the same as in Section 3.2.2.1 except that a precision calibration set with exactly known characteristics is connected between the power divider and RF INPUT. The displayed values are checked at a centre frequency of 100 MHz.

If the generator cannot be set to the reference value with a deviation < 0.01 dB, the actual deviation must be taken into account in the evaluation. Ensure that the S/N ratio is appropriate by selecting the resolution bandwidth.

Maximum permissible level error with a resolution bandwidth of > 30 Hz:

Meas. value display	Measurement range (f < 2 GHz)					
	1 dB	10 dB	20 dB	50 dB	100 dB	110 dB
0 dB	Reference level error: $\pm 0.1 \text{ dB} \pm 0.2 \text{ dB} \pm 0.3 \text{ dB} \pm 0.5 \text{ dB}$					
:	Max. linearity deviation: $\pm 0.1 \text{ dB/dB} \quad \pm 0.2 \text{ dB/dB}$					
-50 dB	Reference level error: $\pm 1.5 \text{ dB}$					
:	Max. linearity deviation: $\pm 0.2 \text{ dB/dB}$ (from -20 dB)					
-100 dB	Reference level error: $\pm 3 \text{ dB (S/N ratio)}$					
-105 dB						

For frequencies $f > 2$ GHz, the error value is increased because of the attenuator as specified in Section 3.2.2.3.

Test setup for 3.2.2.6:

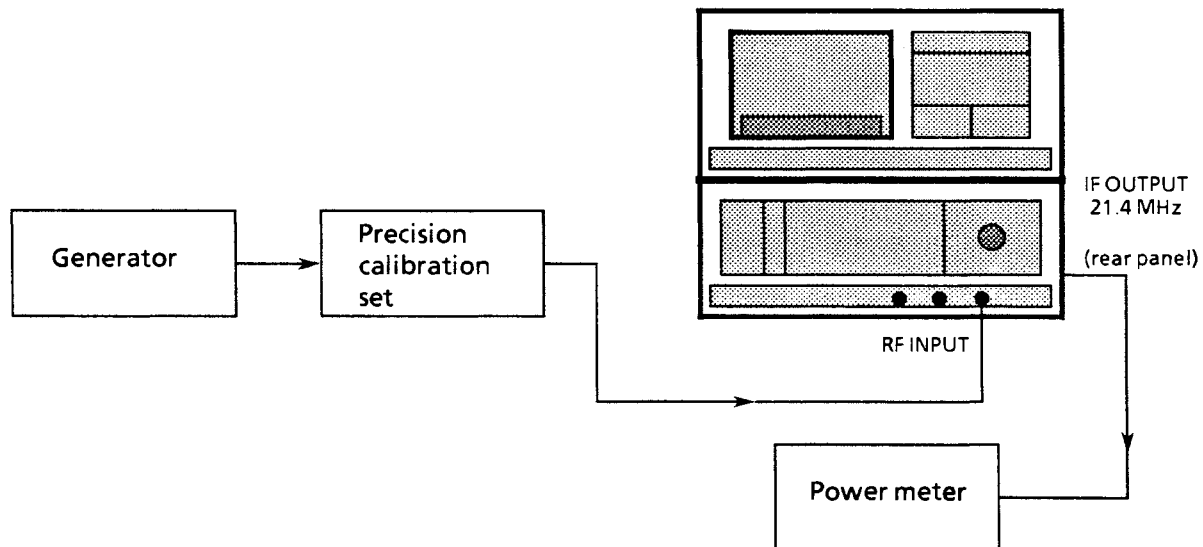

3.2.2.5 Level Display Linearity in Linear Level Range

The setting is the same as in Section 3.2.2.4.

The maximum permissible level error:

$\Delta P = 5\%$ of the reference level + deviation of the actual level from the reference level.

3.2.2.6 IF Level Linearity as a Function of Input Mixer Level

With a constant attenuation of the RF attenuator of 10 dB, apply a level between -20 and +10 dBm to the instrument input.

The power meter display must not deviate by more than 1 dB from the ideal value with a mixer level from -30 to 0 dBm (corresponding to a generator level of -20 to +10 dBm less 10 dB RF attenuation).

3.2.2.7 Level Display Accuracy in Logarithmic Level Ranges at RF Attenuation >10 dB

The maximum permissible level error following a brief calibration:

$$\Delta P = \pm \text{calibration level accuracy} \pm \text{frequency response} \pm [(\text{RF attenuation} - 10 \text{ dB})/5] \times F_{\text{att.}} \pm \text{level display error in the logarithmic level range}$$

Example: a level of 35 dB at full deflection is measured using an RF attenuation of 30 dB in the 50-dB range.

$$\Delta P = \pm 0.2 \text{ dB} \pm 0.6 \text{ dB} \pm 0.8 \text{ dB} \pm 0.5 \text{ dB}$$

$$= \pm 2.1 \text{ dB}$$

$F_{\text{att.}}$ = Error of attenuator per 5-dB step (cf. Section 3.2.2.3)

3.2.2.8 Return Loss of Input

The return loss of the RF input is determined with and without a 10-dB RF attenuation.

Test procedure:

The maximum level at the RF input must be +20 dBm with an RF attenuation of 0 dB or +30 dBm with an RF attenuation of 10 dB.

Remove the connection between the VSWR bridge and the analyzer. The value which appears on the power meter is the reference value. After reestablishing the connection, the return loss is the difference between the reference value and the currently displayed value.

0 dB RF attenuation: VSWR < 3.0 $\hat{=}$ > 6 dB return loss (DC coupling)

10 dB RF attenuation: (f \leq 2.7 GHz)

VSWR \leq 1.5 $\hat{=}$ > 14 dB return loss (DC coupling)

10 dB RF attenuation: (f > 2.7 GHz)

VSWR \leq 1.8 $\hat{=}$ > 10 dB return loss (DC coupling)

Test setup for 3.2.2.7:

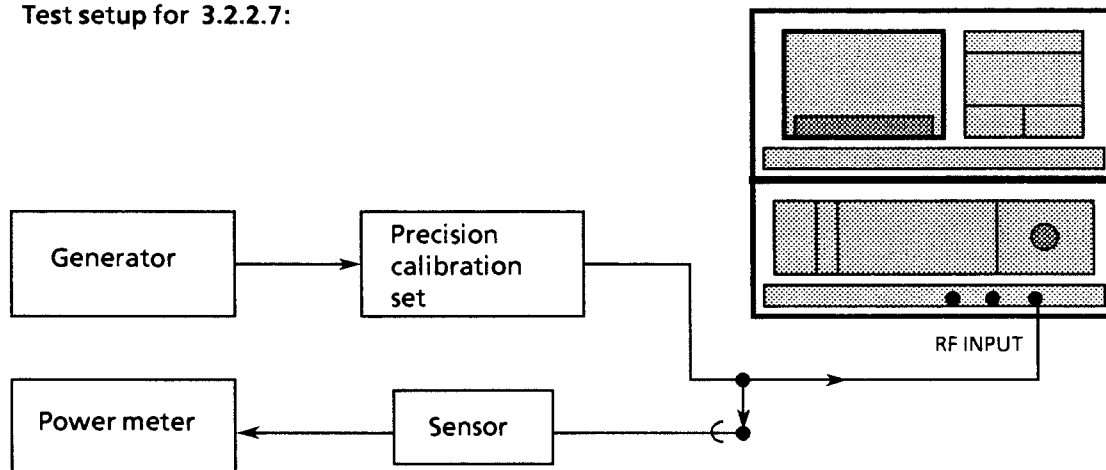

Test setup for 3.2.2.8:

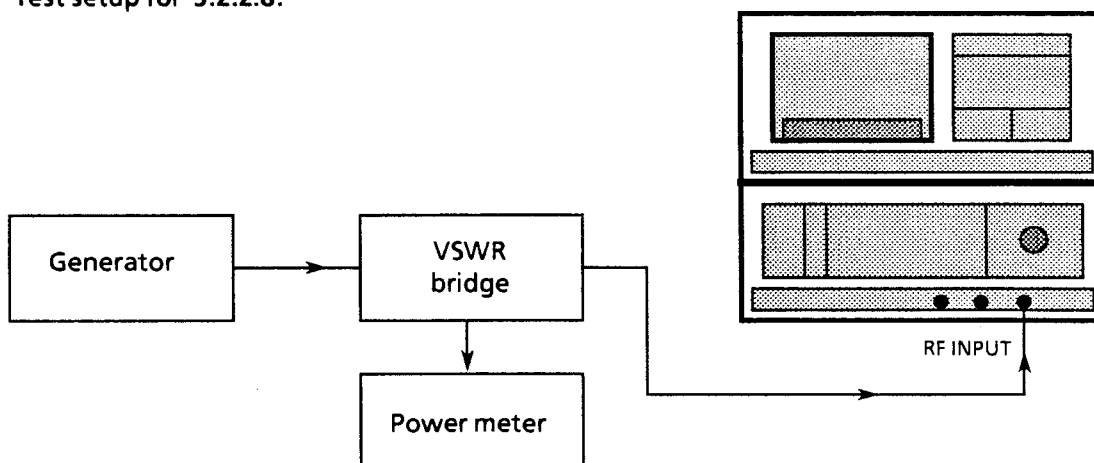

3.2.2.9 Thermal Noise

The maximum sensitivity of the analyzer is defined by the thermal noise of the instrument and the smallest 3-dB resolution bandwidth.

Test procedure:

Connect 50 Ω to analyzer input and enter the following setting values:

RF attenuation 0 dB
 Span 0 Hz
 RBW 6 Hz
 VBW 1 Hz

(The noise displays are approx. 13 dB higher when using the peak-value detector.)

3.2.2.10 Sensitivity at Bottom End of Frequency Range

As a result of the incomplete LO (local oscillator) suppression at low frequencies (see Section 3.2.3.1.1), a sensitivity loss occurs at the bottom end of the frequency range which is not caused by thermal noise. The oscillator noise is reproduced as well as the spurious signals in the oscillator sideband with the corresponding resolution bandwidth.

Test procedure:

Connect 50 Ω to analyzer input (ensure no RF leakage).

RF attenuation 0 dB
 Span 0 Hz
 IF bandwidth 6 Hz
 Video bandwidth 1 Hz
 (excluding sinusoidal spurious)

Centre frequency	Max. noise displayed
200 Hz < f < 1 kHz	<-85 dBm
1 kHz < f < 10 kHz	<-105 dBm
10 kHz < f < 100 kHz	<-110 dBm
100 kHz < f < 1 MHz	<-115 dBm
1 MHz < f < 20 MHz	<-130 dBm
20 MHz < f < 4800 MHz	<-140 dBm
4.8 GHz < f < 5.0 GHz	<-137 dBm

3.2.2.11 Resolution Filters

The selection properties of the internal selection filters are to be determined. Of interest are the 3/6 and 60-dB bandwidths as well as the amplitude and frequency offsets following a total calibration.

Test procedure:

The spectrally pure signal of the internal 10-MHz reference (rear panel) is applied to the RF input. The selection filters are reproduced using this signal (N dB down):

Resolution bandwidth 10 Hz to 3 MHz
 Span = 20 x bandwidth
 Video bandwidth = 0.1 x resolution bandwidth

3.2.3 Spurious Signals

3.2.3.1 Spurious Signals with Terminated Input

3.2.3.1.1 Local Oscillator Suppression at 0 Hz

At a receive frequency of 0 Hz, the oscillator frequency corresponds to the intermediate frequency. Therefore, the oscillator is reproduced with the selection characteristic of the selected resolution filter.

Level of 1st oscillator in normal mode:
 <-15 dBm at 0-dB RF attenuation.

3.2.3.1.2 Further Internal Oscillators

As a result of the finite crosstalk attenuation of the instrument, crosstalk arising from internal oscillators and their harmonics can lead to the display of spurious which mainly occurs at the bottom end of the range.

Frequency	Possible noise source
50/60/400 Hz approx. 50 Hz	Power supply Frame frequency
approx. 30 kHz 100 kHz approx. 116 kHz	Line frequency Reference frequency A/D converter
40 MHz 80 MHz n • 40 MHz	Drive frequency of video amplifier (dot clock)
10 MHz 20 MHz 100 MHz n • 100 MHz	Multiples of reference frequency

Test procedure:

Connect 50 Ω to the analyzer input and switch the RF attenuation to 0 dB.

At a resolution bandwidth of 10 kHz to 30 kHz set the corresponding frequencies, select the frequency step size equal to the frequency and thus also measure the harmonics.

Maximum level of spurious signals: <-110 dBm.

3.2.3.1.3 Spurious Signals as Result of Mixing Procedures

Spurious of this type occur when mixing $N \times f_{OSC1}$ with $M \times f_{OSC2}$ results in an intermediate frequency or image frequency of a conversion.

Test procedure:

Connect 50 Ω to the analyzer input. RF attenuation 0 dB, max. frequency span, resolution bandwidth 30 kHz.

Nominal inherent noise: <-110 dBm.

Frequencies of known spurious signals:

Frequency [MHz]
0.922
22.93
489.82
1133.95
1438.13
1585.73
4757.20

Max. display level in normal mode: <-110 dBm.

3.2.3.2 Spurious Signals with One or More Input Signals

3.2.3.2.1 Spectral Purity of Internal Oscillators

In addition to the unavoidable phase noise, the sidebands of the internal oscillators contain discrete frequencies as a result of crosstalk (see Section 3.2.3.1.2).

Test procedure:

Connect the spectrally pure signal of the internal 10-MHz reference (rear panel) to the RF input. Spurious signals and phase noise can thus be determined at spacings up to ± 1 MHz. Spurious signals of higher frequency do not occur in the sideband with corresponding levels. The phase noise is determined using the noise marker.

Fixed spurious signals

50/60/400 Hz	-70 dBc
$m * 29.411 \text{ kHz}$	-80 dBc
100 kHz	-90 dBc

Phase noise (dBc/1 Hz) *

> 100 Hz offset	≤ -95
> 1 kHz offset	≤ -105
> 10 kHz offset	≤ -110
> 30 kHz offset	≤ -113
> 100 kHz offset	≤ -115
> 300 kHz offset	≤ -115

* Span = < 5 MHz
Resolution bandwidth = < 3 kHz
Video bandwidth = < 0.1 x resolution bandwidth

3.2.3.2.2 Variable-frequency Spurious Signals in Oscillator Sidebands

Crosstalk of the frequency processing generates spurious signals in the sideband of the mixer oscillators whose frequency offset is variable and not fixed. The characteristic of these spurious signals is that they only appear when an input signal is applied.

Maximum level: -75 dBc (referred to reference level).

Test setup: as in Section 3.2.1.2 (ensure spectral purity of generator).

Test setup for 3.2.3.2.4:

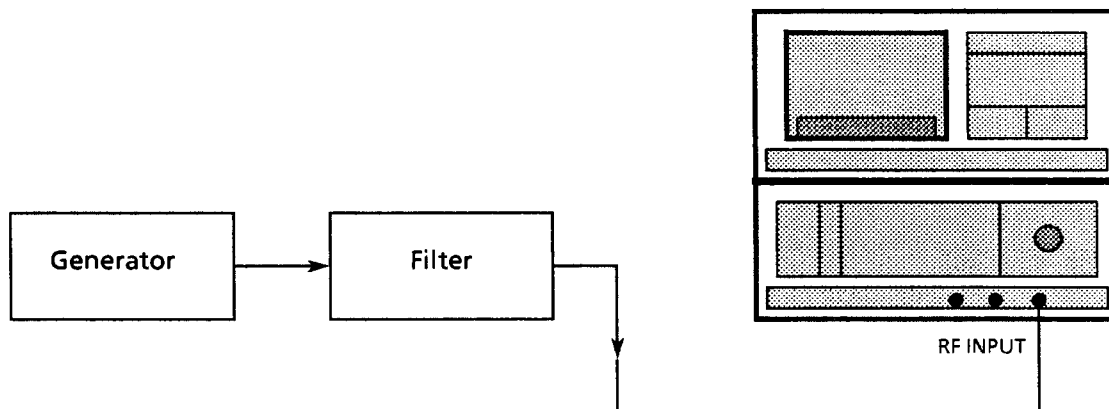

3.2.3.2.3 Spurious FM

The spurious FM of the internal oscillators is determined according to Section 3.2.3.2.1.

Centre frequency 10 MHz
Span 100 Hz
Resolution bandwidth 10 Hz
Video bandwidth 1 Hz
Maximum spurious FM < 1 Hz pp

The spurious FM is determined from the display of the filter curve. With a continuous curve, the spurious FM is $\ll 1$ Hz pp.

3.2.3.2.4 Harmonics Resulting from Single Input Signal

Harmonics of frequency $N \times f$ occur in the case of a single input signal with frequency f as a result of the finite linearity of the input mixer.

The insufficient harmonics suppression of the generator must be appropriately improved using an additional lowpass or bandpass filter (approx. 70 dB are necessary).

Test procedure:

Apply a frequency f with a level of -30 dBm (corresponding to -40 dBm at input mixer), use this as the reference and measure at frequencies $2 \times f$ to $5 \times f$.

Spurious	Range	Suppression
2f	40 MHz < f < 2500 MHz	> -80 dBc
3f	40 MHz < f < 1666 MHz	> -75 dBc
4f	40 MHz < f < 1250 MHz	> -75 dBc
5f	40 MHz < f < 1000 MHz	> -75 dBc

3.2.3.2.5 Spurious Resulting from Intermodulation of Two Input Signals

In the case of two input signals with f_1 and f_2 applied to the input mixer, combinations of these signals appear as a result of non-linearity:

2nd order differential signals: $f_1 + f_2$ and $f_2 - f_1$

3rd order differential signals: $2 \times f_2 - f_1$ and $2 \times f_1 - f_2$.

The insufficient harmonics suppression of the generators must be correspondingly improved by series-connected filters. The level spacing of each signal from its harmonics and intermodulation products must be > 100 dB at the RF input.

Test procedure:

Apply frequencies f_1 and f_2 with a level of -20 dBm (corresponding to -30 dBm at the input mixer). This is to be used as the reference. Measure at the frequencies $2 \times f_2 - f_1$ and $2 \times f_1 - f_2$.

The following applies at a frequency > 40 MHz and a signal spacing larger than 100 kHz:

Intermodulation products > 75 dB (operating mode "Low Distortion").

Test setup for 3.2.3.2.5:

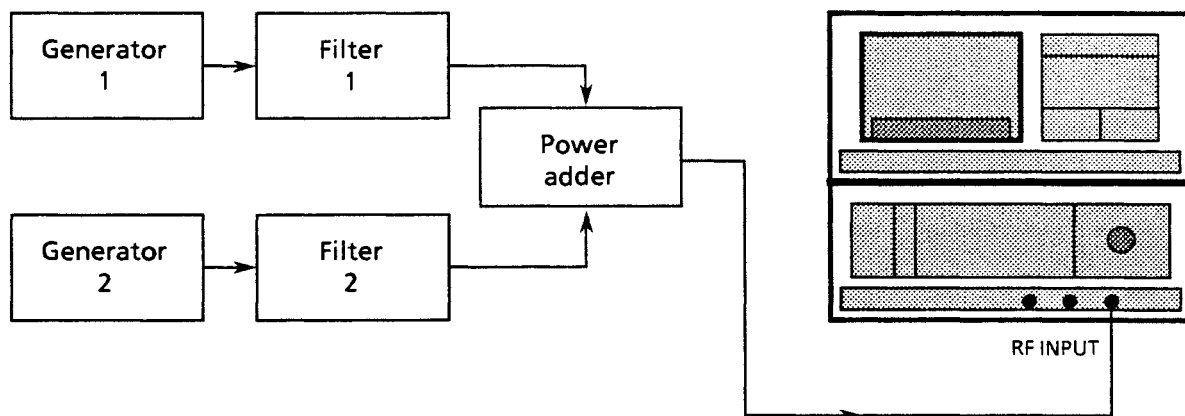

3.2.3.2.6 IF Rejection

An input signal whose frequency corresponds to one of the IF frequencies and whose level corresponds to the reference value should not have an influence greater than the thermal noise.

Test procedure:

Tune the generator to three possible IF frequencies in succession. The fundamental noise should not increase at an input level corresponding to the reference level. Problems resulting from broadband noise of the generator must be prevented by inserting a suitable bandpass filter. The resolution bandwidth of the filter is 10 Hz, the video bandwidth 1 Hz.

f_{noise}	Suppression	Noise increase
221.4 MHz	>100 dB	<3 dB
21.4 MHz	>100 dB	<3 dB
4.194 MHz	>100 dB	<3 dB

3.2.3.2.7 Image Frequency Rejection

Test procedure as in Section 3.2.3.2.4. The noise frequencies depend on the centre frequency in this case.

f_{noise}	Suppression	Noise increase
$f_e + 10842.8 \text{ MHz}$	>80 dB	<10 dB
$f_e + 442.8 \text{ MHz}$	>100 dB	<3 dB
$f_e + 42.8 \text{ MHz}$	>100 dB	<3 dB
$f_e + 8.388 \text{ MHz}$	>100 dB	<3 dB

Test setup for 3.2.3.2.6:

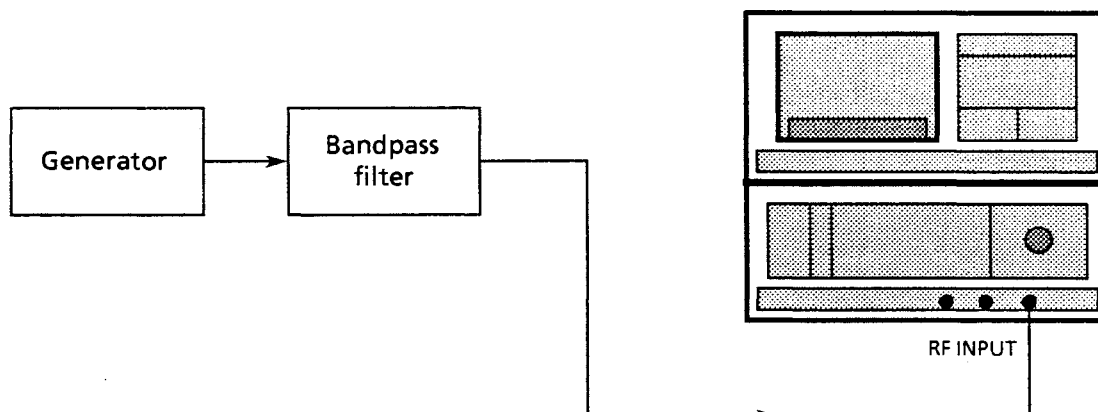

3.3 Performance Test Report

Rohde & Schwarz

SPECTRUM ANALYZER FSB

Order No. 848.0020.52

Serial No.

Date

Name

Item No.	Characteristic	Measurement as in Section	Min.	Actual	Max.	Unit
1	Internal reference	3.2.1.1	9.999999	-----	10.000001	MHz
2	Frequency accuracy Centre Span frequency 2500 MHz 5000 MHz 2500 MHz 900 MHz 2500 MHz 450 MHz 2500 MHz 200 MHz 2500 MHz 100 MHz 2500 MHz 50 MHz 2500 MHz 10 MHz 2500 MHz 5 MHz 2500 MHz <5 MHz	3.2.1.2	2484 2492.8 2496.4 2498.4 2499.2 2499.6 2499.92 2499.96 2499.9889	----- ----- ----- ----- ----- ----- ----- ----- -----	2516 2507.2 2503.6 2501.6 2500.8 2500.4 2500.08 2500.04 2500.0111	MHz MHz MHz MHz MHz MHz MHz MHz MHz
3	Span accuracy Span 5000 MHz 2000 MHz 200 MHz 20 MHz 5.01 MHz 5.0 MHz 2000 Hz	3.2.1.3	4975 1990 199 19.9 4.985 4.990 1996	----- ----- ----- ----- ----- ----- -----	5025 2010 201 20.1 5.0351 5.010 2004	MHz MHz MHz MHz MHz Hz Hz
4	External reference Level ≥ 0.1 V	3.2.1.4	>9.999990	-----	<10.000010	MHz
5	CAL out level 100 MHz	3.2.2.1	-20.1	-----	-19.9	dBm
6	RF frequency response 40 MHz to 5.0 GHz					
	RF attenuation: 10 dB	3.2.2.2	-21.0	-----	-19.0	dBm
	f ≤ 2.7 GHz	3.2.2.3	-11.4 -1.8 +7.8 +17.4 +27.0	----- ----- ----- ----- -----	-8.6 +1.8 +12.2 +22.6 +33.0	dBm dBm dBm dBm dBm
	f ≥ 2.7 GHz		-12 -12.25 +7.5 +17.25		-8 -7.75 +12.5 +22.75	dBm dBm dBm dBm

Item No.	Characteristic	Measurement as in Section	Min.	Actual	Max.	Unit
7	Log. level range 100 110 dB	3.2.2.4				
	-20 dBm			-20		dBm
	-21 dBm		-21.1	-----	-20.9	dBm
	-22 dBm		-22.2	-----	-21.8	dBm
	-23 dBm		-23.3	-----	-22.7	dBm
	-24 dBm		-24.4	-----	-23.6	dBm
	-25 dBm		-25.5	-----	-24.5	dBm
	-26 dBm		-26.6	-----	-25.4	dBm
	-27 dBm		-27.7	-----	-26.3	dBm
	-28 dBm		-28.8	-----	-27.2	dBm
	-29 dBm		-29.9	-----	-28.1	dBm
	-30 dBm		-31.0	-----	-29.0	dBm
	-32 dBm		-33.5	-----	-30.5	dBm
	-34 dBm		-35.5	-----	-32.5	dBm
	-36 dBm		-37.5	-----	-34.5	dBm
	-38 dBm		-39.5	-----	-36.5	dBm
	-40 dBm		-41.5	-----	-38.5	dBm
	-45 dBm		-46.5	-----	-43.5	dBm
	-50 dBm		-51.5	-----	-48.5	dBm
	-55 dBm		-56.5	-----	-53.5	dBm
	-60 dBm		-61.5	-----	-58.5	dBm
	-65 dBm		-66.5	-----	-63.5	dBm
	-70 dBm		-71.5	-----	-68.5	dBm
	-75 dBm		-76.5	-----	-73.5	dBm
	-80 dBm		-81.5	-----	-78.5	dBm
	-85 dBm		-86.5	-----	-83.5	dBm
	-90 dBm		-91.5	-----	-88.5	dBm
	-95 dBm		-96.5	-----	-93.5	dBm
	-100 dBm		-101.5	-----	-98.5	dBm
	-105 dBm		-106.5	-----	-103.5	dBm
	-110 dBm		-111.5	-----	-108.5	dBm
	-115 dBm		-116.5	-----	-113.5	dBm
	-120 dBm		-121.5	-----	-118.5	dBm
	-125 dBm		-130.0	-----	-120.0	dBm
	1 dB					
	-20 dBm			-20		dBm
	-20.1 dBm		-20.12	-----	-20.08	dBm
	-20.2 dBm		-20.24	-----	-20.16	dBm
	-20.3 dBm		-20.36	-----	-20.24	dBm
	-20.4 dBm		-20.48	-----	-20.32	dBm
	-20.5 dBm		-20.60	-----	-20.40	dBm
	-20.6 dBm		-20.72	-----	-20.48	dBm
	-20.7 dBm		-20.84	-----	-20.56	dBm
	-20.8 dBm		-20.96	-----	-20.64	dBm
	-20.9 dBm		-21.08	-----	-20.72	dBm
	-21.0 dBm		-21.20	-----	-20.80	dBm

Item No.	Characteristic	Measurement as in Section	Min.	Actual	Max.	Unit
8	Lin. level range	3.2.2.5	0	100	0	%
	100 %		75	-----	85	%
	80 %		55	-----	65	%
	60 %		35	-----	45	%
	40 %		15	-----	25	%
	20 %		0	-----	10	%
	5 %					
	Lin/log switchover					
	Without calibration		-1	-----	+1	dB
	With calibration		-0.2	-----	+0.2	dB
9	Linearity IF level	3.2.2.6		0		dB
	-30 dBm			-----	+11	dB
	-20 dBm level at		+9	-----	+21	dB
	-10 dBm 1st mixer		+19	-----	+31	dB
	0 dBm		+29	-----		dB
10	Level accuracy with log. (various settings, corresponding tolerance)	3.2.2.7				
11	Input VSWR	3.2.2.8	---	-----	<3.0	---
	RF attenuation 0 dB		---	-----	<1.5 at	---
	RF attenuation ≥ 10 dB				f ≤ 2.7 GHz	
					<1.8 at	
					f > 2.7 GHz	
12	Thermal noise 2501 MHz RBW = 10 Hz VBW = 1 Hz Span = 100 Hz	3.2.2.9	---	-----	<-140	dBm
13	Sensitivity for 0 < f < 40 MHz	3.2.2.10				
	19.9 MHz		---	-----	<-130	dBm
	999 kHz		---	-----	<-115	dBm
	99.99 kHz		---	-----	<-110	dBm
	9.99 kHz		---	-----	<-105	dBm
	990 Hz		---	-----	<-85	dBm
	210 Hz		---	-----	<-85	dBm

Item No.	Characteristic	Measurement as in Section	Min.	Actual	Max.	Unit	
14	Resolution filter (calibrated)	3.2.2.11					
	Resolution bandwidths (calibrated)						
	3 MHz		2.7	-----	3.3	MHz	
	1 MHz		0.9	-----	1.1	MHz	
	0.3 MHz		0.27	-----	0.33	MHz	
	0.1 MHz		0.09	-----	0.11	MHz	
	30 kHz		27	-----	33	kHz	
	10 kHz		9	-----	11	kHz	
	3 kHz		2.7	-----	3.3	kHz	
	1 kHz		0.9	-----	1.1	kHz	
	0.3 kHz		0.27	-----	0.33	kHz	
	0.1 kHz		0.09	-----	0.11	kHz	
	30 Hz		27	-----	33	Hz	
	10 Hz		9	-----	11	Hz	
	Frequency offset (calibrated)						
	3 MHz		-300	-----	+ 300	kHz	
	1 MHz		-100	-----	+ 100	kHz	
	0.3 MHz		-30	-----	+ 30	kHz	
	0.1 MHz		-10	-----	+ 10	kHz	
	30 kHz		-3	-----	+ 3	kHz	
	10 kHz		-1	-----	+ 1	kHz	
	3 kHz		-300	-----	+ 300	Hz	
	1 kHz		-100	-----	+ 100	Hz	
	0.3 kHz		-30	-----	+ 30	Hz	
	0.1 kHz		-10	-----	+ 10	Hz	
	30 Hz		-10	-----	+ 10	Hz	
	10 Hz		-10	-----	+ 10	Hz	
	Level (referred to 3 kHz) (calibrated)						
	3 MHz		-0.3	-----	+ 0.3	dB	
	1 MHz		-0.3	-----	+ 0.3	dB	
	0.3 MHz		-0.3	-----	+ 0.3	dB	
	0.1 MHz		-0.3	-----	+ 0.3	dB	
	30 kHz		-0.3	-----	+ 0.3	dB	
	10 kHz		-0.3	-----	+ 0.3	dB	
	3 kHz		0	-----	0	dB	
	1 kHz		-0.3	-----	+ 0.3	dB	
	0.3 kHz		-0.3	-----	+ 0.3	dB	
	0.1 kHz		-0.3	-----	+ 0.3	dB	
	30 Hz		-0.3	-----	+ 0.3	dB	
	10 Hz		-0.3	-----	+ 0.3	dB	

Item No.	Characteristic	Measurement as in Section	Min.	Actual	Max.	Unit
14	Resolution filter (calibrated) Skirt selectivity 3 MHz 1 MHz 0.3 MHz 0.1 MHz 30 kHz 10 kHz 3 kHz 1 kHz 0.3 kHz 0.1 kHz 30 Hz 10 Hz	3.2.2.11	—	-----	<12:1 <12:1 <12:1 <12:1 <12:1 <12:1 <12:1 <12:1 <12:1 <12:1 <12:1 <12:1 <12:1	— — — — — — — — — — — — —
15	Local oscillator suppression	3.2.3.1.1	—	-----	<-15	dBm
16	Fixed spurious signals	3.2.3.1.2	—	-----	<-110	dBm
17	Spurious signals caused by mixing	3.2.3.1.3	—	-----	<-110	dBm
18	Spectral purity > 100 Hz > 1 kHz > 10 kHz > 30 kHz > 100 kHz > 300 kHz Fixed spurious signals n × 50/60/400 Hz approx. 30 kHz 100 kHz 200 kHz	3.2.3.2.1	— — — — — —	----- ----- ----- ----- ----- -----	<-95 <-105 <-110 <-113 <-115 <-115 <-70 <-80 <-90 <-90	dBc/1Hz dBc/1Hz dBc/1Hz dBc/1Hz dBc/1Hz dBc/1Hz dBc dBc dBc dBc
19	Variable spurious signals YIG oscillator	3.2.3.2.2	—	-----	<-75	dBc
20	Spurious FM Span = 0 Hz	3.2.3.2.3	—	-----	<1	Hz

Item No.	Characteristic	Measurement as in Section	Min.	Actual	Max.	Unit
21	Harmonics	3.2.3.2.4	—	-----	<-80	dBc
22	3rd order intermodulation	3.2.3.2.5	—	-----	<-75	dBc
23	IF rejection 221.4 MHz 21.4 MHz 4.194 MHz	3.2.3.2.6	— — —	----- ----- -----	> 100 > 100 > 100	dB dB dB
24	Image frequency rejection fe + 10842.8 MHz fe + 442.8 MHz fe + 42.8 MHz fe + 8.388 MHz	3.2.3.2.7	— — — —	----- ----- ----- -----	> 80 > 100 > 100 > 100	dB dB dB dB

3.4 Maintenance

3.4.1 Cleaning

The external surfaces and the interior of the instrument should be cleaned depending on the frequency or length of use.

Interior:

The instrument (especially the display unit) should be cleaned every 6 months using compressed air or a vacuum cleaner to remove dust particles deposited as a result of electrostatic charges.

Front panel:

The front panel should be cleaned every 6 months using a soft cloth soaked in methylated spirits. Aggressive solvents such as trichloroethylene, turpentine or acetone must not be used.

Clean the CRT using a damp lint-free cloth. The surface of the tube is chemically etched and must never be treated using products which produce a polished effect.

3.4.2 Mechanical Maintenance

The two units (display unit, RF unit) each contain one blower in the rear panel and one in the power pack. The blowers are maintenance-free and do not have filters.

Apart from the blowers, the keyboard, the spinwheel and the input divider, the instrument contains no mechanical parts subject to wear. The instrument therefore requires no mechanical maintenance.

3.4.3 Electrical Maintenance

The electrical maintenance must be carried out once a year. The accuracy of the following two characteristics must be checked:

Frequency accuracy:

- 10-MHz reference (see Section 3.2.1.1)
- Control voltage range of all oscillators (see details in corresponding service manual)

10-MHz crystal oscillator
100-MHz crystal oscillator
Sweep synthesizer
M synthesizer
N synthesizer
Summing loop
YIG pretune
YIG synchronization
2nd oscillator
IF filter 2 (crystal oscillator)

Amplitude accuracy and sensitivity
(see details in Section 3.2.2)

3.4.4 Battery Replacement

The display unit contains a battery to power the CMOS RAMs, in which important instrument parameters are stored AC-power-proof. The battery has a very long service life (approx. 10 years). If the instrument is mostly used at ambient temperatures above 30 °C, the battery should be replaced approx. every 3 years as a precaution.

Replacing the battery: (see exploded view in Appendix of display unit service manual):

- Remove the top panel of the display unit.
- Unscrew the cover.
- Remove the main processor module.
- Replace the battery.

Caution: the battery must only be replaced by one of the same type (Order No. 565.1687).

The module should be powered via a diode and an external power pack when replacing the battery so that the stored calibration values are retained.

The diode and the external supply can be removed after replacing the battery.

- Reassemble in the reverse order.
- Check the calibration.

If, however, the measuring equipment listed in the following table is available, proceed as described in the following.

Measuring and test equipment required	R&S order number
● Cable set (long)	811.0304.02
● Service Kit FS-Z1	811.0010.02
● BASIC program (floppy disk)	811.0185
● RF Generator SWM	814.7016.05
● RF Generator SMX	826.4517.52
● Relay Matrix PSU	290.8014.02
● Power Splitter 2 x 50 Ω 0 to 5 GHz	
● RF Voltmeter URV5	394.8010.02
● Precision power sensor NRV-Z2	828.3218.02
● Insertion Unit URV5-Z4	395.1619.55
● 50-Ω Termination RNB	272.4910.50
● Bandpass filter 21.4 MHz Bandwidth approx. 5 to 50 kHz with known insertion loss	811.0910.00 (contained in Service Kit FS-Z1)
● Process Controller PCA5	375.2010.04
● Printer PUD, if required	359.5501.02

3.4.5 Programming the EEPROM for Frequency Response Correction

Following replacement of one of the instrument modules listed in the following table, it is advisable to reprogram the EEPROM in module A34 (preamplifier 3rd IF). This is necessary in order to maintain the accuracy specified in section 3.3, item 6.

The same applies to repair work carried out on one of these modules and referring to components in the RF signal paths.

Module	Designation
Attenuator	A31
RF Module	A32/A33
YIG Pretune	A43
YIG Synchronization	A42

This job should usually be done by an R&S service shop.

a) Preliminary work on the analyzer

- Disconnect the connecting cable between X132 of the display unit and X132 of the RF unit.
- Mount filter 811.0910.00 (contained in Service Kit FS-Z1) to X132 of the RF unit.

The test setup is as shown on the next page.

Note:

When setting up the insertion unit at input B of the URV5, make sure that it is separated from the housing of the analyzer.

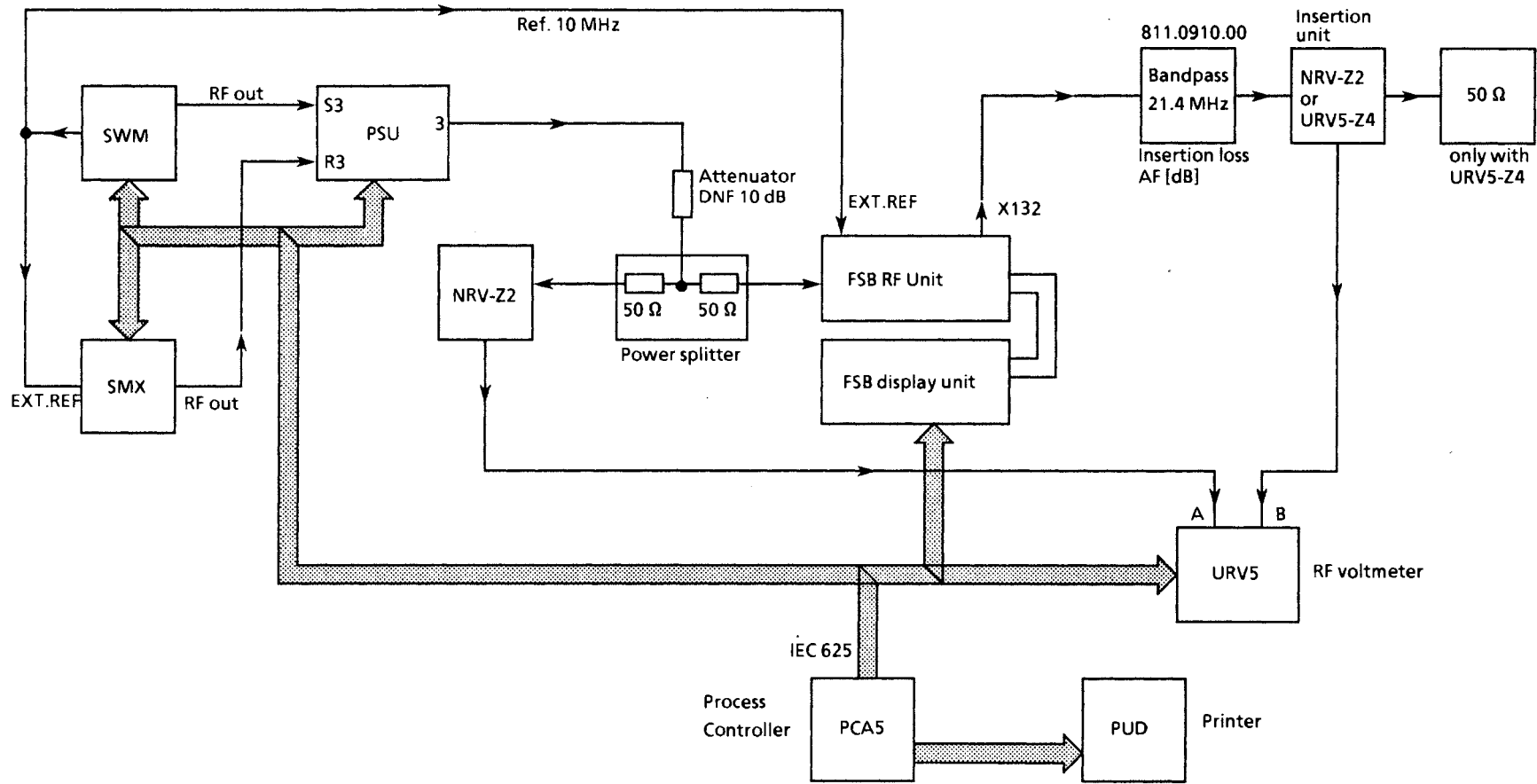

Test setup for programming the EEPROM on module A34

b) Programming procedure

- Insert floppy disk into Controller PCAS, load program in BASIC mode using LOAD "A:FSB6.BAS" and start.
The user is guided through the program by means of menus.
- Enter attenuation of bandpass filter 21.4 MHz.
- The following operations can be performed:
 - ① Measurement of uncorrected frequency response of FSB (duration approx. 20 min.)
 - ③ Programming of EEPROM and measurement of corrected and uncorrected frequency response (duration approx. 60 min.)
 - ⑤ Printout of frequencies and associated correction data.
 - ⑥ Printout of graphics for corrected and uncorrected frequency response as well as for correction data.
 - ⑨ End of program.

Note:

It is recommended to measure the uncorrected frequency response prior to programming in order to make sure that it lies within the correctable range.

- Start programming.
- After completion of programming, both the uncorrected and the corrected frequency response can be output on the printer.

c) Reassembling

- Unscrew bandpass filter from X132.
- Reassemble connecting cable.

3.5 Storage

It is recommendable to remove the internal battery (see Section 3.4.4) if the instrument is to be stored for a longer period at extremely high or low temperatures. The storage temperature range is $-40\text{ }^{\circ}\text{C}$ to $+70\text{ }^{\circ}\text{C}$. In the case of a high temperature and a high humidity, it is recommendable to seal the dry instrument in plastic foil with a dessicator bag, or at least to cover it with wax paper as airproof as possible.

After storing for a longer period at high humidity, proceed as follows:

- Switch on the instrument and allow to dry for a period of 2 to 6 hours at $+40\text{ }^{\circ}\text{C}$ to $+55\text{ }^{\circ}\text{C}$.
- Install the battery as in Section 3.4.4.
- Check the rated specifications as in Section 3.2.

Bilder

Figures

Figures

