

Arbitrary Waveform Generator

AWG5000B Series (AWG5014B • AWG5012B • AWG5004B • AWG5002B)

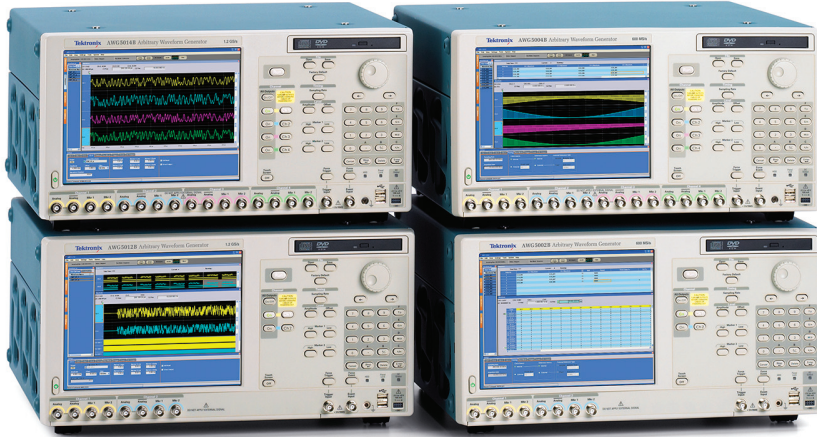

AWG5000B Series.

The AWG5000B Series of Arbitrary Waveform Generators Delivers the Industry's Best Mixed Signal Stimulus Solution for Today's Complex Measurement Challenges

The AWG5000B Series of Arbitrary Waveform Generators delivers the optimal combination of industry leading sample rate, vertical resolution, signal fidelity and waveform memory length, all in an easy to use self contained package. The series offers the industry's best solution to the challenging signal stimulus issues faced by designers verifying, characterizing and debugging sophisticated electronic designs.

Meeting the needs of today's design engineers, the series provides excellent signal dynamic range and integrity. AWG5000B Series models, with a 14-bit DA converter based sample rate from 600 MS/s to 1.2 GS/s, 2 to 4 output channels, synchronized 4 to 8 digital marker outputs and 28 channels of digital data outputs, easily solve the toughest measurement challenges in wireless base band I/Q communications, digital consumer product design such as imaging devices, data conversion equipment and semiconductor design and test.

The open windows (Windows XP) based instruments are easy and convenient to use and connect easily with peripherals and third party software.

Wireless I/Q and IF Signal Generation

Tektronix AWGs support "Wireless Everywhere" by enabling the latest Digital RF technology, increasing wireless network capacity and delivering the performance that supports higher modulation bandwidth and modulation schemes.

The AWG5000B Series' 1.2 GS/s, (600 MS/s), with enough signal dynamic range and SFDR via 14-bit vertical resolution meets Narrowband IQ applications to broadband IF applications. The AWG5000B is able to generate not only analog IQ/IF signals, but digital data IQ/F. The MIMO (Multiple Input Multiple Output) system that supports W-LAN/Wi-Max using space-multiplex with multiple antennas is a leading edge technology for reliable and faster data rate communication. The AWG5000B Series generates up to four analog channels (8 channels via two instruments) to simultaneously generate MIMO signals. The series can generate two pairs of IQ signals (4-pairs with two instruments) as an IQ generator and four pairs of IF signals (8-pairs with two instruments) as an IF generator. With the two channels models, CH 1 and CH 2 digital data output is available as an option.

Features & Benefits

1.2 Gs/s and 600 MS/s models

14-bit vertical resolution

2 or 4 arbitrary waveform differential/single-ended outputs

- Up to 4.5 V_{p-p} single-ended and 9 V_{p-p} at differential output into 50 Ω
- 0.95 ns Tr/Tf (10 to 90%) at 0.6 V_{p-p}
- +/- 5 ns range (50 ps resolution) inter channel skew control
- SFDR: 80 dBc (1 MHz), 64 dBc (10 MHz)

4 or 8 variable level marker outputs

- Up to 3.7 V_{p-p} single-ended output into 50 Ω
- 300 ps Tr/Tf (20 to 80%) at 0 to 1 V
- Up to 1 ns range (50 ps resolution) delay control

28-bit CH 1/CH 2 variable level digital data output

- Up to 3.7 V_{p-p} single-ended output into 50 Ω
- 300 ps Tr/Tf (20 to 80%) at 0 to 1 V

Up to 32 M point record length for longer data streams

Down to 800 ps resolution edge timing shift control

800 steps real-time sequencing creates infinite waveform loops, jumps and conditional branches

Easy to use and learn shortens test time

Intuitive user interface based on Windows XP

Convenient bench top form factor

Integrated PC supports network integration and provides a built-in DVD, removable hard drive, LAN and USB ports

Applications

Designing, testing and deploying

Wireless communications:

- High fidelity quadrature modulation I and Q base-band signals (polar modulation: I/Q + magnitude control, two pair of I/Q for MIMO)

Imaging

- Stimulus signals for imaging display and recording devices (CCD, LCD)

Data Conversion

- Stimulus signals for data conversion devices (ADC, DAC)

Mixed signal design and test

- 2/4 CH analog + 4/8 CH marker outputs + 28-bit digital data outputs

Real-world, ideal or distorted signal generation – including all the glitches, anomalies and impairments

Enhanced/corrupted playback of DSO captured signals

Waveform vectors imported from third-party tools such as MathCAD, MATLAB, Excel and others

Arbitrary Waveform Generator

AWG5000B Series (AWG5014B • AWG5012B • AWG5004B • AWG5002B)

Spurious Performance

The 14-bit vertical resolution and sophisticated design of the AWG5000B Series provides ample signal dynamic range and purity. The SFDR performance is 80 dBc for 1 MHz signal and 64 dBc for 10 MHz signal.

Multi-level Logic Signal

One technique to increase the data rate without increasing the transition rate is applying multi-level signals, wherein a signal can assume more than the standard binary two levels. In multi-level signaling, one can think of multi-level discrete amplitudes of a signal. This phenomenon is known as pulse amplitude-modulation or PAM. A 9PAM signal, a signal with 9 different amplitudes, increases the data rate by four without increasing the transition rate of the signal.

The AWG5000B Series enables you to test your latest design by generating any kind of mixed or multi-level signal.

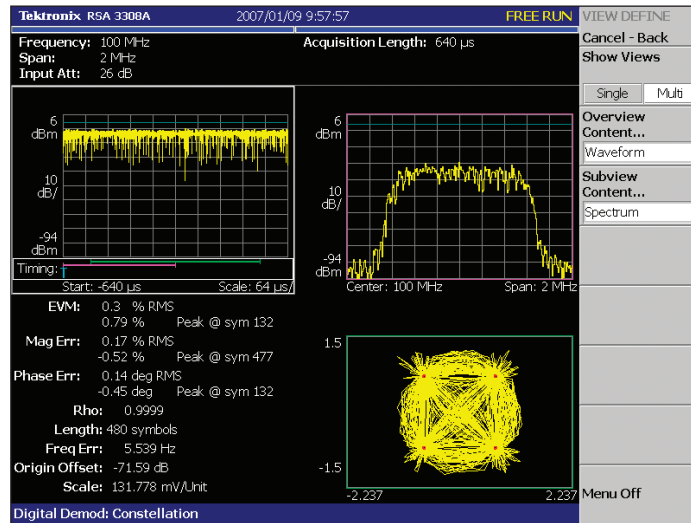

EVM/Constellation measurement.

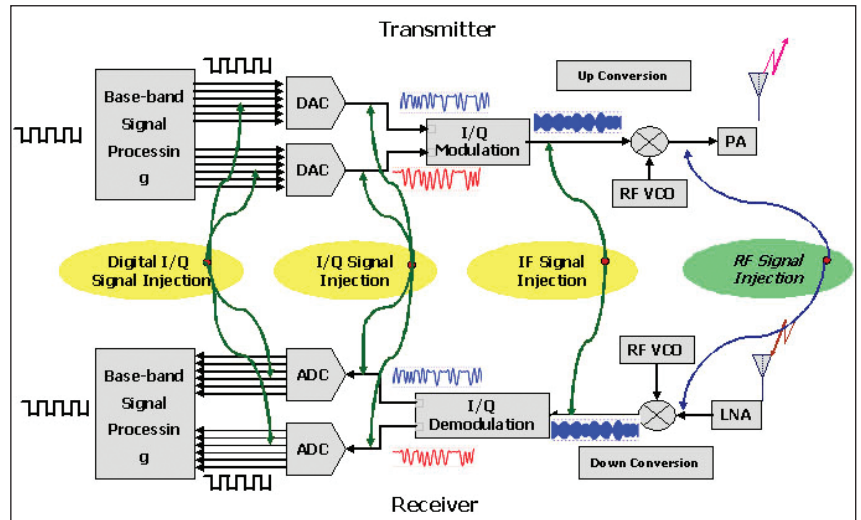

Typical signal injection.

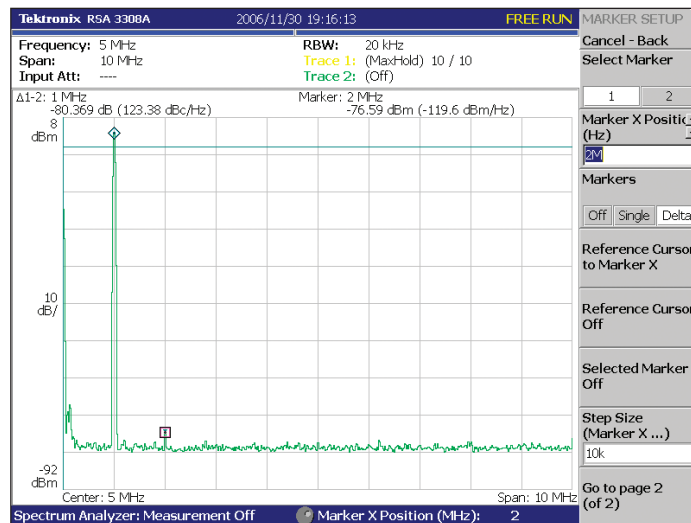

RTSA spectrum view.

Arbitrary Waveform Generator

AWG5000B Series (AWG5014B • AWG5012B • AWG5004B • AWG5002B)

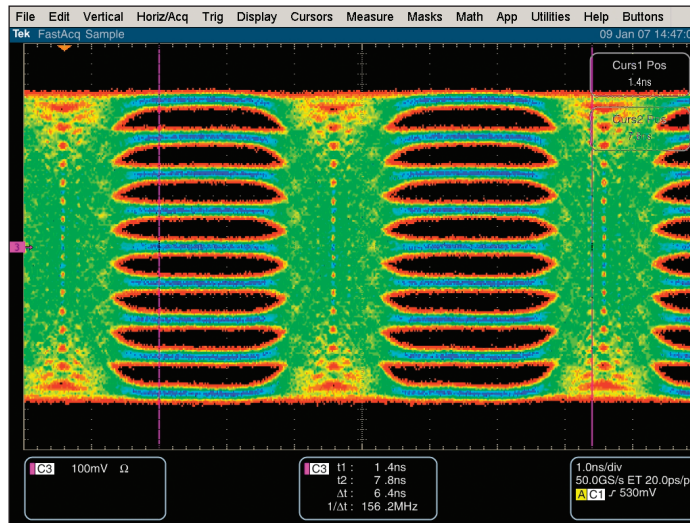

9-PAM with 250 Mbps.

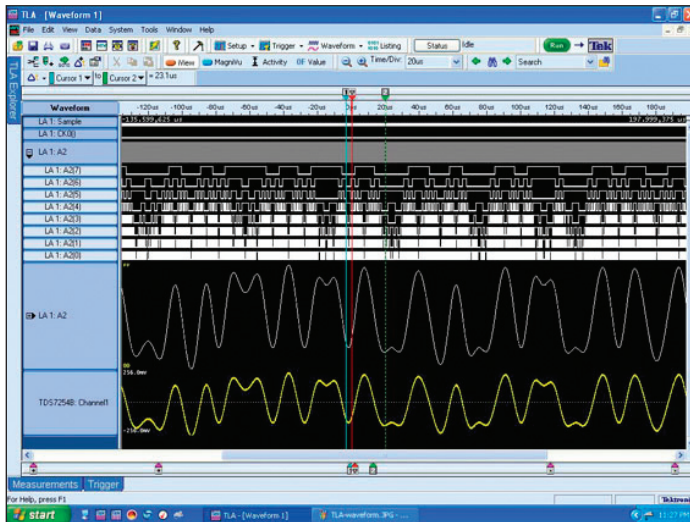

Mixed signal test by TDS/TLA iView.

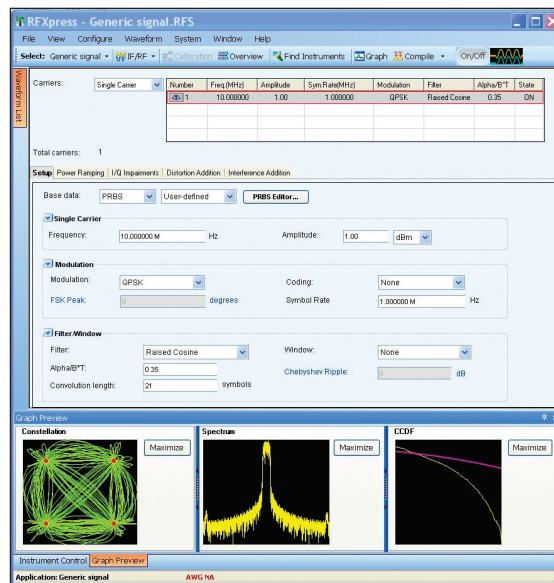

Mixed Signal Generation

AWG5012B and AWG5002B models can generate two analog signals with four digital marker outputs, supporting 28 digital outputs (CH 1 and CH 2 data) as an option. They deliver a mixed analog and digital signal generator and the most versatile solution for a broad range of applications, including consumer electronics such as ADC/DAC converter and imaging or display devices.

Additional Software Application Tools to Extend Waveform Generation

RFXpress® (RFX100)

RFXpress is a software package that synthesizes digitally modulated base band IQ and IF signals. It takes IQ and IF signal generation to the next level and fully exploits the wideband signal generation capabilities of Arbitrary Waveform Generators (AWGs). Supporting a wide range of modulations, as well as the symbol map functions, the software allows you to define your own modulation.

RFXpress is a powerful easy to use software package to synthesize IQ and IF signals for arbitrary waveform generators (AWG). It runs as an integral part of the AWG5000B series arbitrary waveform generators or from an external PC. For more details on RFXpress visit www.tek.com.

Arbitrary Waveform Generator

AWG5000B Series (AWG5014B • AWG5012B • AWG5004B • AWG5002B)

Characteristics

	AWG5014B	AWG5012B	AWG5004B	AWG5002B
Arbitrary Waveform Output				
Digital to Analog Converter				
Resolution	14-bit			
Number of Outputs	4	2	4	2
Output Type	Differential			
Output Impedance	50 Ω			
Output Connector Type	BNC (front panel)			
Sampling Rate	10 M to 1.2 Gsample/sec		10 M to 600 Msample/sec	
Frequency Characteristics				
Effective RF Frequency (Fmax)	Fmax determined as the lower of "Effective bandwidth (-6 dB)" or "Max sampling rate/2.5 points per cycle"			
(Typical)	370 MHz		240 MHz	
Effective Freq Switching Time	Minimum frequency switching time (from selected frequencies F1 to F2) is determined as "1/Fmax"			
Standard (typical)	400 ns		800 ns	
Option 08 (typical)	2.7 ns		4.2 ns	
Sinewave Characteristics	1.2 Gsample/sec clock, 32 points per waveform 37.50 MHz carrier frequency, 1.0 V peak-to-peak		0.6 Gsample/sec clock, 32 points per waveform 18.75 MHz carrier frequency, 1.0 V peak-to-peak	
Amplitude Characteristics				
Rise Time Bandwidth (-3dB)	Analog bandwidth converted from rise time characteristics through analog output and filtering circuitry			
(Typical)	Normal: 250 MHz Direct: 370 MHz			
Low Pass Filter	Normal: 20 MHz, 100 MHz (Bessel type) Direct: N/A			
Amplitude				
Range	Normal: 20 mV to 4.5 V peak-to-peak Direct: 20 mV to 0.6 V peak-to-peak			
Resolution	1 mV			
Accuracy	\pm (2.0% of amplitude \pm 2 mV) at offset = 0 V			
Offset				
Range	Normal: -2.25 V to + 2.25 V Direct: N/A			
Resolution	1 mV			
Accuracy	\pm (2% of offset \pm 10 mV) at minimum amplitude			
Distortion Characteristics				
Harmonic Distortion	Normal: \leq -40 dBc Direct: \leq -49 dBc		Normal: \leq -46 dBc Direct: \leq -55 dBc	
Non-harmonic Spurious	\leq -60 dBc (DC to 600 MHz)		\leq -60 dBc (DC to 300 MHz)	
Spurious Free Dynamic Range	1.2 Gsample/sec clock, amplitude: 1 Vpp, offset: 0 V 14-bit DAC operational mode, DC to 600 MHz		0.6 Gsample/sec clock, amplitude: 1 Vpp, offset: 0 V 14-bit DAC operational mode, DC to 300 MHz	
(Typical)	50 dBc (Normal: 37.5 MHz, 1.2 GS/s, 2.0 Vpp) 60 dBc (Normal: 10 MHz, 600 MS/s, 1.0 Vpp) 80 dBc (Normal: 1 MHz, 600 MS/s, 1.0 Vpp) 64 dBc (Direct: 10 MHz, 600 MS/s, 0.6 Vpp) 80 dBc (Direct: 1 MHz, 600 MS/s, 0.6 Vpp)		56 dBc (Normal: 18.75 MHz, 600 MS/s, 2.0 Vpp) 60 dBc (Normal: 10 MHz, 600 MS/s, 1.0 Vpp) 80 dBc (Normal: 1 MHz, 600 MS/s, 1.0 Vpp) 64 dBc (Direct: 10 MHz, 600 MS/s, 0.6 Vpp) 80 dBc (Direct: 1 MHz, 600 MS/s, 0.6 Vpp)	
Phase Noise	1.2 Gsample/sec clock, amplitude: 1 V _{p-p} , offset: 0 V carrier frequency 37.50 MHz		6 Gsample/sec clock, amplitude: 1 V _{p-p} , offset: 0 V carrier frequency 18.75 MHz	
(typical)	\leq -85 dBc/Hz at 10 kHz offset			
Random Jitter	1010 clock pattern			
rms (typical)	Normal: 5 ps			
Total Jitter	2 [^] 15-1 PN data pattern (@10 ⁻¹² BER)			
Peak-to-Peak (typical)	Normal: 150 ps			
Pulse Characteristics				
Pulse Response				
Rise/Fall Time (10 to 90%)	Normal: 1.4 ns (at 2.0 V peak-to-peak) Direct: 0.95 ns (at 0.6 V peak-to-peak)			
Overshoot	Less than 10% (at 0.6 V peak-to-peak)			

Arbitrary Waveform Generator

AWG5000B Series (AWG5014B • AWG5012B • AWG5004B • AWG5002B)

	AWG5014B	AWG5012B	AWG5004B	AWG5002B
Arbitrary Waveforms				
Waveform Length	1 to 16,200,000 points (or 1 to 32,400,000 points, option 01)			
Number of Waveforms	1 to 16,000			
Sequence Length	1 to 8,000 steps total			
Sequence Repeat Counter	1 to 65,536 or infinite.			
Sequence Control	Repeat count, Wait for Trigger, Go-to-N and Jump The standard model requires "wait for trigger ON" for all sequence step definition, the option 08 (fast sequence switching) selectable On or Off for each sequence step			
Jump Mode	Synchronous and Asynchronous			
Run Modes				
Continuous	Waveform is iteratively output. If a sequence is defined, the sequence order and repeat functions are applied			
Triggered	Waveform is output only once when an external, internal, GPIB, LAN or manual trigger is received			
Gated	Waveform begins output when gate is true and resets to beginning when false			
Sequence	Waveform is output as defined by the sequence			
Sampling Clock				
Resolution	8 digits			
Internal Clock				
Accuracy	With in \pm (1 ppm + Aging), Aging: with in \pm 1 ppm/year			
Internal Trigger Generator				
Internal Trigger Rate				
Range	1.0 μ s to 10.0 s			
Resolution	3 digits, 0.1 μ s minimum			
Skew Control Between Outputs				
Range	-5ns to +5ns			
Resolution	5ps			
Auxiliary Outputs				
Marker Output				
Number of Outputs	8 (2 per CH)	4 (2 per CH)	8 (2 per CH)	4 (2 per CH)
Output Style	Single Ended			
Output Impedance	50 Ω			
Connector	BNC Front			
Level (into 50 Ω)	(Twice for Hi_Z input)			
Output Windows	-1.00 V to + 2.7 V			
Amplitude	0.10 V _{p-p} to 3.7 V _{p-p}			
Resolution	10 mV			
DC Accuracy	\pm (10% of setting +120 mV)			
Maximum Output Current	\pm 54 mA /ch			
Rise/Fall Time (20% to 80%)	300 ps (1.0 V _{p-p} , Hi +1.0 V, Lo 0 V)			
Skew Adjust Between Markers				
Range	0 to 1000 ps			
Resolution	50 ps			
Random Jitter (Typical)	1010 clock pattern			
RMS (Typical)	5 ps _{rms}			
Total Jitter	2 ¹⁵⁻¹ PN data pattern			
Peak-to-Peak (p-p) (Typical)	80 ps _{p-p}			
Clock (VCO) Out				
Range	600 MHz to 1.2 GHz			
Amplitude	0.4 V _{p-p} into 50 Ω to GND			
Impedance	50 Ω , AC coupling			
Connector	BNC Rear			
10 MHz Reference Out				
Amplitude	1.2 V _{p-p} into 50 Ω . Max 2.5 V _{p-p} open.			
Impedance	50 Ω , AC coupling			
Connector	BNC Rear			

Arbitrary Waveform Generator

AWG5000B Series (AWG5014B • AWG5012B • AWG5004B • AWG5002B)

	AWG5014B	AWG5012B	AWG5004B	AWG5002B
DC Outputs				
Number of Outputs		4: independently controlled outputs		
Range		-3.0 to +5.0 V		
Resolution		10 mV		
Output Voltage Accuracy		+/- (3% of the setting + 120 mV)		
Max. Current		± 100 mA		
Connector		2x4 pin header on front panel		
Digital Data Output (Option 03)				
Number of Output	NA	14-bit output on channel 1 and channel 2 (28 total)	NA	14-bit output on channel 1 and channel 2 (28 total)
Output Style		Single-ended		Single-ended
Output Impedance		50 Ω		50 Ω
Connector		SMB rear		SMB rear
Level (into 50 Ω) (Twice for Hi_Z Input)				
Output Windows		-1.00 V to + 2.7 V		-1.00 V to + 2.7 V
Amplitude		0.10 V _{p-p} to 3.7 V _{p-p}		0.10 V _{p-p} to 3.7 V _{p-p}
Resolution		10 mV		10 mV
DC Accuracy		± (10% of setting +120 mV)		± (10% of setting +120 mV)
Maximum Output Current		± 54 mA /ch		± 54 mA /ch
Rise/Fall Time (20% to 80%)		300 ps (1.0 V _{p-p} , Hi +1.0 V, Lo 0 V)		300 ps (1.0 V _{p-p} , Hi +1.0 V, Lo 0 V)
Delay from Marker		-41 ns to to 82 ns		-41 ns to to 82 ns
Skew Between Digital Outputs		Less than 400 ps		Less than 400 ps

Auxiliary Inputs

Trigger In –

Impedance: 1 kΩ or 50 Ω.

Polarity: POS or NEG.

Connector: BNC Front.

Input Voltage Range – 1 kΩ: ±10 V. 50 Ω: ±5 V.

Threshold –

Level: -5.0 V to 5.0 V.

Resolution: 0.1 V.

Trigger Jitter – 2.0 ns to 4.5 ns (Typical).

Asynchronies Between Internal/External Clock and Trigger Timing (Typical) – 2.0 ns to 4.5 ns.

Trigger Mode –

Minimum Pulse Width: 20 ns.

Trigger Hold-off:

160* sampling_period to 200 ns.

Delay to Analog Out:

48* sampling_period + 500 ns.

Gate Mode –

Minimum Pulse Width:

1024* sampling_period + 10 ns.

Delay to Analog Out:

240* sampling_period + 500 ns.

Event Input

Impedance: 1 kΩ or 50 Ω.

Polarity: POS or NEG.

Connector: BNC Front.

Input Voltage Range: 1 kΩ: ±10 V. 50 Ω: ±5 V.

Threshold: -5.0 V to 5.0 V.

Resolution: 0.1 V.

Sequence Mode –

Minimum Pulse Width: 20 ns.

Event Hold Off: 200* Sampling Period + 500 ns (Jump timing: Asynchronous jump).

Delay to Analog Out: 260* Sampling Period + 300 ns.

External Clock IN –

Input Voltage Range: 0.2 V_{p-p} to 0.8 V_{p-p}.

Impedance: 50 Ω, AC coupled.

Frequency Range: 600 MHz to 1.2 GHz.

Clock Divider: 1/1, 1/2, 1/4.....1/32; 1/2, 1/4.....1/32.

Connector: BNC Rear.

Reference Clock IN –

Input Voltage Range: 0.2 V_{p-p} to 3.0 V_{p-p}.

Impedance: 50 Ω, AC coupled.

Frequency Range: 10 MHz, 20 MHz, 100 MHz (with ±0.5%).

Connector: BNC Rear.

Phase Lock IN –

Input Ranges: 5 MHz to 600 MHz

(acceptable frequency drift is ±0.5%).

Input Voltage Range: 0.2 V_{p-p} to 3 V_{p-p}.

Impedance: 50 Ω, AC coupled.

Multiple Rate: 1 to 240, 1 to 120.

Connector: BNC Rear.

Add IN – For each analog channel.

Impedance: 50 Ω, DC coupled.

DC Gain: 1.

Bandwidth: DC to 100 MHz at -3 dB.

Input Voltage Range: ± 1.0 V.

Connector: BNC Rear.

AWG5000B Series Common Features

Waveform File Import Capability – Tektronix TDS5000/6000/7000, DPO4000/7000/70000, DSA70000 (*.wfm). TDS3000 (*.wfm) AWG400s/500s/610/615/710/710B (*.wfm, *.pat, *.seq), DTG5000s (*.DAT) Text data file (3rd party software creation waveform data: MATLAB, MathCad, Excel).

S/W Driver for 3rd party S/W – IVI-com driver and MATLAB library.

Instrument Control/Data Transfer Ports

GPIB – Remote control and data transfer. (Conforms to IEEE-Std 488.1, compatible with IEEE 488.2 and SCPI-1999.0).

Ethernet (10/100/1000Base-T) – Remote control and data transfer. (Conforms to IEEE 802.3). RJ-45.

Computer System and Peripherals – Windows XP Professional, 2 GB SDRAM, 80 GB removable Hard Drive at rear (available front mount kit), CD-RW/DVD drive at front, included USB compact keyboard and mouse.

PC I/O Ports – USB 2.0 compliant ports (6 total, 2 front, 4 rear), PS/2 mouse and keyboard connectors (rear panel), RJ-45 Ethernet connector (rear panel) supports 10/100/1000 BASE-T, XGA out.

Display Characteristics – 10.4 inch, LCD color display with touch screen, 1024 (H) x 768 (V) (XGA).

Power Supply – 100 to 240 VAC, 47 to 63 Hz.

Power Consumption – 450 W.

Safety – UL61010-1, CAN/CSA-22.2, No.61010-1-04, EN61010-1, IEC61010-1.

Emissions – EN 55011 (Class A), IEC61000-3-2, IEC61000-3-3.

Immunity – IEC61326, IEC61000-4-2/3/4/5/6/8/11.

Regional Certifications

Europe – EN61326.

Australia/New Zealand – AS/NZS 2064.

Physical Characteristic

Dimension	mm	in.
Height	245	9.6
Width	465	18.0
Length	500	19.7
Weight (approx.)		
Net	19.5	43.0
Net with Package	28.5	62.8

Mechanical Cooling

Required Clearance	cm	in.
Top and Bottom	2	0.8
Side	15	6
Rear	7.5	3

Environmental

	Operating	Non-operating
Temperature	+10° C to +40° C	-20° C to +60° C
Humidity	5% to 80% relative humidity (% RH) at up to +30° C, 5% to 45% RH above +30° C up to +50° C	5% to 90% RH (Relative Humidity) at up to +30° C, 5% to 45% RH above +30° C up to +50° C,
Altitude	Up to 3,048 meters (10,000 feet)	Up to 12,192 meters (40,000 feet)
Random Vibration	0.27 G _{RMS} , 5 to 500 Hz, 10 minutes per axis	2.28 G _{RMS} , 5 to 500 Hz, 10 minutes per axis
Sine Vibration	0.33 mm _{p-p} (0.013 inch _{p-p}) constant displacement, 5 55 Hz	NA
Mechanical Shock	Half-sine mechanical shocks, 30 g peak amplitude, 11 msec duration, 3 drops in each direction of each axis	NA

Ordering Information

Arbitrary Waveform Generator Mainframe

AWG5014B

1.2 Gsample/sec, 14-bit resolution, 16 Mpoint per channel, 4-channel arbitrary waveform generator.

AWG5012B

1.2 Gsample/sec, 14-bit resolution, 16 Mpoint per channel, 2-channel arbitrary waveform generator.

AWG5004B

600 Msample/sec, 14-bit resolution, 16 Mpoint per channel, 4-channel arbitrary waveform generator.

AWG5002B

600 Msample/sec, 14-bit resolution, 16 M point per channel, 2-channel arbitrary waveform generator.

All models include: Accessory pouch, front cover, USB mouse, compact USB key board, lead set for DC output, stylus for touch screen (2 ea), AWG5000B series product software CD and instructions, documentation CD with browser, Quick Start User Manual and registration card, Certificate of Calibration and power cable.

Note: Please specify power cord and language option when ordering.

Instrument Options

AWG5014B, AWG5012B, AWG5004B and AWG5002B

Opt. 01 – Waveform Length Expansion (from 16 M to 32 M).

Opt. 08 – Fast sequence switching (requires export control license). ECCN:3A002.

AWG5012B/ AWG5002B

Opt. 03 – 28-bit digital data outputs (digital data of CH1 and CH2).

Common Options

Note: Please specify power cord and language option at time of order.

International Power Plugs

Opt. A0 – North America.

Opt. A1 – Universal EURO.

Opt. A2 – United Kingdom.

Opt. A3 – Australia.

Opt. A5 – Switzerland.

Opt. A6 – Japan.

Opt. A10 – China.

Opt. A11 – India.

Opt. A99 – No power cord or AC adapter.

Language Options

Opt. L0 – English.

Opt. L5 – Japanese.

Opt. L7 – Simplified Chinese.

Opt. L8 – Traditional Chinese.

Opt. L10 – Russian.

Application Software

RFX100 – General-purpose IQ, IF and RF Signal Creation Software Package.

Opt. UWBCF – RFXpress® plug-In for UWB-WiMedia IQ, IF and RF conformance signal creation (requires RFX100 as prerequisite).

Opt. UWBCI – RFXpress plug-In for UWB-WiMedia IQ, IF and RF custom and performance signal creation (requires RFX100 as prerequisite and includes Option UWBCF).

SDX100 – Jitter Generation Software Package (includes USB dongle).

Opt. ISI – S-Parameter and ISI creation (requires SDX100 as prerequisite).

Opt. SSC – Spread Spectrum Clock addition option (requires SDX100 as prerequisite).

Service Options

Opt. CA1 – A single calibration event.

Opt. C3 – Calibration service 3 years.

Opt. C5 – Calibration service 5 years.

Opt. D1 – Calibration data report.

Opt. D3 – Calibration data report 3 years (with option C3).

Opt. D5 – Calibration data report 5 years (with option C5).

Opt. R3 – Repair service 3 years.

Opt. R5 – Repair service 5 years.

Post-sales Service Options: (e.g., AWG5012-CA1)

CA1 – A single calibration event.

R3DW – Repair service coverage 3 years.

R5DW – Repair service coverage 5 years.

R2PW – Repair service coverage 2 years post warranty.

R1PW – Repair service coverage 1 year post warranty.

Arbitrary Waveform Generator

AWG5000B Series (AWG5014B • AWG5012B • AWG5004B • AWG5002B)

Contact Tektronix:

ASEAN/Australasia (65) 6356 3900

Austria +41 52 675 3777

Balkans, Israel, South Africa and other ISE Countries +41 52 675 3777

Belgium 07 81 60166

Brazil & South America (11) 40669400

Canada 1 (800) 661-5625

Central East Europe, Ukraine and the Baltics +41 52 675 3777

Central Europe & Greece +41 52 675 3777

Denmark +45 80 88 1401

Finland +41 52 675 3777

France +33 (0) 1 69 86 81 81

Germany +49 (221) 94 77 400

Hong Kong (852) 2585-6688

India (91) 80-22275577

Italy +39 (02) 25086 1

Japan 81 (3) 6714-3010

Luxembourg +44 (0) 1344 392400

Mexico, Central America & Caribbean 52 (55) 5424700

Middle East, Asia and North Africa +41 52 675 3777

The Netherlands 090 02 021797

Norway 800 16098

People's Republic of China 86 (10) 6235 1230

Poland +41 52 675 3777

Portugal 80 08 12370

Republic of Korea 82 (2) 6917-5000

Russia & CIS +7 (495) 7484900

South Africa +27 11 206 8360

Spain (+34) 901 988 054

Sweden 020 08 80371

Switzerland +41 52 675 3777

Taiwan 886 (2) 2722-9622

United Kingdom & Eire +44 (0) 1344 392400

USA 1 (800) 426-2200

For other areas contact Tektronix, Inc. at: 1 (503) 627-7111

Updated 12 November 2007

Product Upgrade

Product	Options to Upgrade	Description
AWG5014B	Opt. M14	Waveform Length Expansion from 16 M point to 32 M point
	Opt. S48	Upgrade from standard to Option 08 (fast sequence switching) requires export license
AWG5012B	Opt. M12	Waveform Length Expansion from 16 M point to 32 M point
	Opt. D13	Digital Data Outputs
	Opt. S38	Upgrade from Standard to Option 08 (fast sequence switching) requires export license
AWG5004B	Opt. M04	Waveform Length Expansion from 16 M point to 32 M point
	Opt. S28	Upgrade from Standard to Option 08 (fast sequence switching) requires export license
AWG5002B	Opt. M02	Waveform Length Expansion from 16 M point to 32 M point
	Opt. D03	Digital Data Outputs
	Opt. S18	Upgrade from Standard to Option 08 (fast sequence switching) requires export license

Recommended Accessories

Item	Description	Parts Number
Pin Header Cable		
SMA Cable	102 cm (40 inch)	012-1690-00
SMB Cable	51 cm (20 inch)	012-1503-00
Rackmount Kit	Rackmount Kit with instruction	016-1983-01
Front Removable HDD Bay	Front Removable HDD Bay	016-1979-01
Replacement Hard Disk for AWG5000/7000 Series	SATA disk assembly (no software installation), Instruction sheet	065-0811-00
Quick Start User Manual	English	071-2481-00
	Japanese	071-2482-00
	Simplified Chinese	071-2483-00
	Traditional Chinese	071-2484-00
	Russian	020-2971-00
Service Manual	Service Manual, English	Visit Tektronix Web site

Warranty

One-year parts and labor.

For Further Information

Tektronix maintains a comprehensive, constantly expanding collection of application notes, technical briefs and other resources to help engineers working on the cutting edge of technology. Please visit www.tektronix.com



Product(s) are manufactured in ISO registered facilities.

Product(s) complies with IEEE Standard 488.1-1987, RS-232-C, and with Tektronix Standard Codes and Formats.

Copyright © 2008, Tektronix. All rights reserved. Tektronix products are covered by U.S. and foreign patents, issued and pending. Information in this publication supersedes that in all previously published material. Specification and price change privileges reserved. TEKTRONIX and TEK are registered trademarks of Tektronix, Inc. All other trade names referenced are the service marks, trademarks or registered trademarks of their respective companies.
07/08 HB/WOW 76W-22260-0

