

Power View

Power Analyzer PZ4000



- Wide measurement bandwidth (DC, up to 2 MHz)
- Accurately capturing of input waveforms using high-speed (maximum 5 MS/s) sampling
 - Voltage and current waveform display and analysis functions to enable power calculations on fluctuating inputs
- Harmonic analysis (up to 500th order) and Fast Fourier Transform (FFT) functions to enable high-frequency power spectrum analysis
 - Simultaneous measurement of many channels using multiple units and external trigger function
- Environmentally friendly design based on YOKOGAWA's "Guidelines for Designing Products for the Environment" and "Criteria for Environmental Assessment in Product Design."
 - Sensor input module enables evaluation of motor efficiency and total efficiency.

Power View

A new power measurement from YOKOGAWA

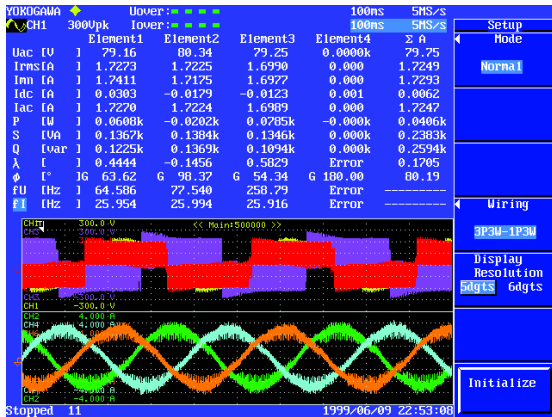

Example of output signal check for an inverter-driven 3-phase motor

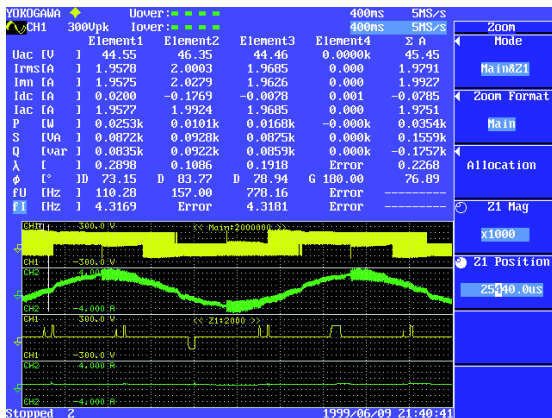

Example of check using zoom function to determine whether pulse waveforms are fully acquired during low-rpm operation

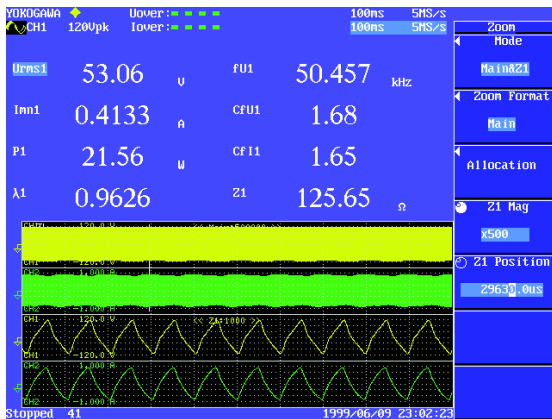

Example of measurements on inverter lighting equipment with a fundamental wave of approximately 50 kHz

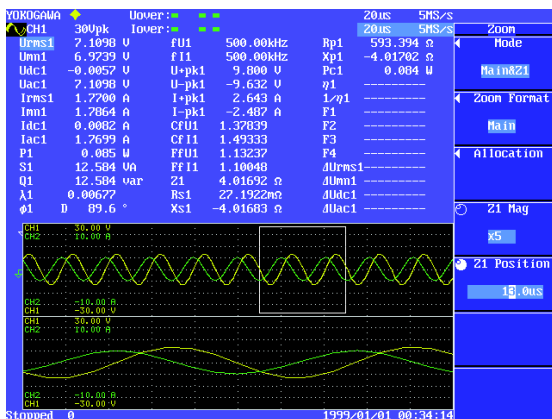

Example of loss measurement during high-frequency capacitor driving (500 kHz)

A power meter that displays measured waveforms

Measured voltages and currents are sampled at high speed (maximum 5 MS/s). Power is calculated from the sampled data along with accurately displayed waveforms.

Benefits for the user

Correlation between displayed waveforms and calculated power values

Waveform displays and calculated values (e.g., power values) are based on sampled data stored in internal memory, so they are correlated with each other.

Check measurement effectiveness easily

Measured waveforms and calculated values can be checked at the same time to prevent erroneous measurements.

No probe needed for waveform measurements

Voltage and current waveforms can be measured without using oscilloscope differential probes and current probes. The PZ4000 can make waveform measurements much more accurately than with conventional oscilloscopes.

Wide bandwidth, high-precision measurements

Measurements can be made over a wide frequency range (DC up to 2 MHz), making it possible to measure power loss on electronic components, high-frequency lighting equipment, and other devices.

Benefits for the user

High precision power measurements at high frequency

The PZ4000 lets you make high-precision measurements of voltage, current, and consumed power in equipment driven at frequencies ranging from several tens of kHz to approximately 100 kHz.

Lamp current measurement in fluorescent bulb

With the PZ4000, you can measure lamp current of fluorescent bulb using Delta Computation function. It computes the difference of the instantaneous values between output current of electric ballast and cathode current.

Loss measurement when actual load is applied to electronic components

With the PZ4000, you can measure power loss resulting from actual load applications, instead of evaluating characteristics based on small signals using an LCR meter or impedance analyzer.

Power measurements on extremely low-frequency signals

Take full advantage of the 4M word internal memory (optional; enough for 4 million samples) to obtain precise measurements of extremely low-frequency (several mHz) signals.

A power meter capable of dynamically capturing load fluctuations

Internal memory (maximum 4 M words) stores your measurements. You can calculate and display voltage, current, and power values for specific portions of the total memory (equivalent to 100 k words of data). The display makes it easy to see how the load fluctuates with time.

Benefits for the user

Inrush current and power measurements (at switch-on)

In the past, it was necessary to measure inrush current and power values at power-on using measuring instruments such as oscilloscopes. The PZ4000 makes these measurements much more accurately and greatly simplifies this procedure.

Power measurements in specific states (specific spans in internal memory)

Power measurements on equipment with fluctuating loads are normally obtained by measuring the energy in certain operating patterns over a long time period using an integration function. The average power value is then calculated. In contrast, The PZ4000 lets you make power measurements over a specific period defined by adjustable cursors. This reduces the time required for measurements.

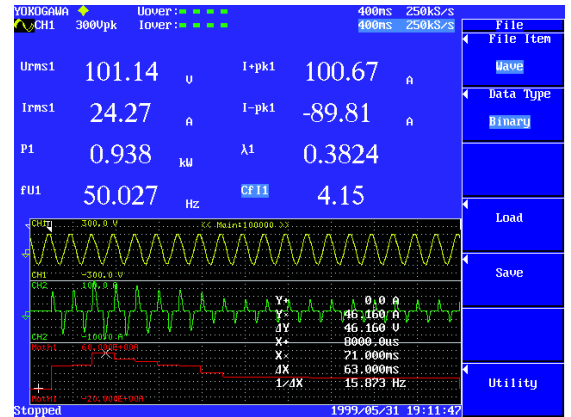

Example of inrush current measurement in an inverter-type cleaner



Example of efficiency evaluation when inverter output is turned on in a cooking machine using induction heating

Graphical power analysis

The PZ4000 lets you analyze harmonics (up to 500th order) using high-speed sampling. With the FFT calculation function, you can perform spectrum analysis in the high-frequency range (up to 2.5 MHz). Analysis results are displayed on spectrum graphs. In addition, vectors showing the fundamental components of distorted waveforms can be displayed to give a visual presentation of the load balance in a 3-phase power supply system.

Benefits for the user

Distorted wave power spectrum analysis

With the PZ4000, you don't need a frequency analyzer to perform spectrum analysis on the carrier component of an inverter. Up to now, this type of analysis is difficult. A major advantage with the PZ4000 is that you can input signals directly without using probes. This removes any error due to probe tolerance.

The load balance evaluation in a three-phase equipment

The vector display using the harmonic analysis function lets you visually know the condition of each phase in a 3-phase equipment. This makes evaluation simpler than when calculations are performed manually based on numerical data.

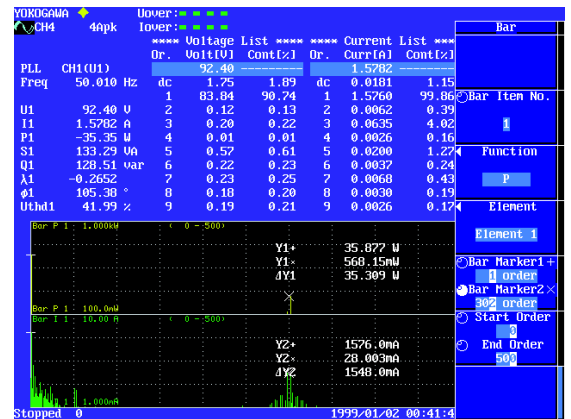

Example of spectrum analysis of current and power in inverter output

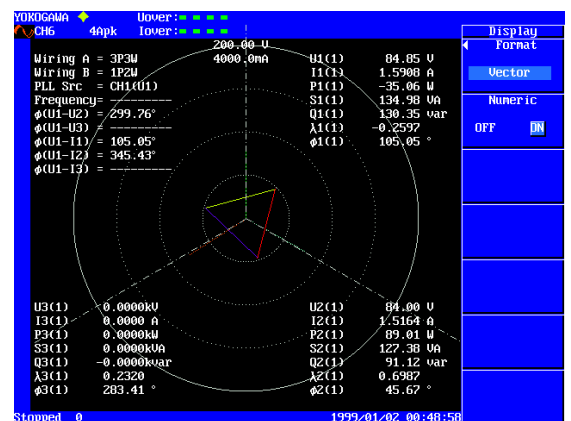

Example of fundamental wave vector display in inverter output

PZ4000 Power Analyzer

A power meter based on new concepts

The PZ4000 is a power analyzer based on a new set of concepts and designed for R&D work relating to environmentally friendly energy-conserving products and technologies. These products and technologies were the focus of the Third Conference of the Parties to the United Nations Framework Convention on Climate Change (COP3; held in Kyoto in December 1997), and are rapidly being adopted around the world. In

order to support R&D for these products and technologies, the PZ4000 was designed based on YOKOGAWA's Environmentally Harmonious Product Design Guidelines and Product Design Environmental Assessment Standards, which are intended to protect the global environment. The PZ4000 has been developed and produced at ISO14001-approved offices.

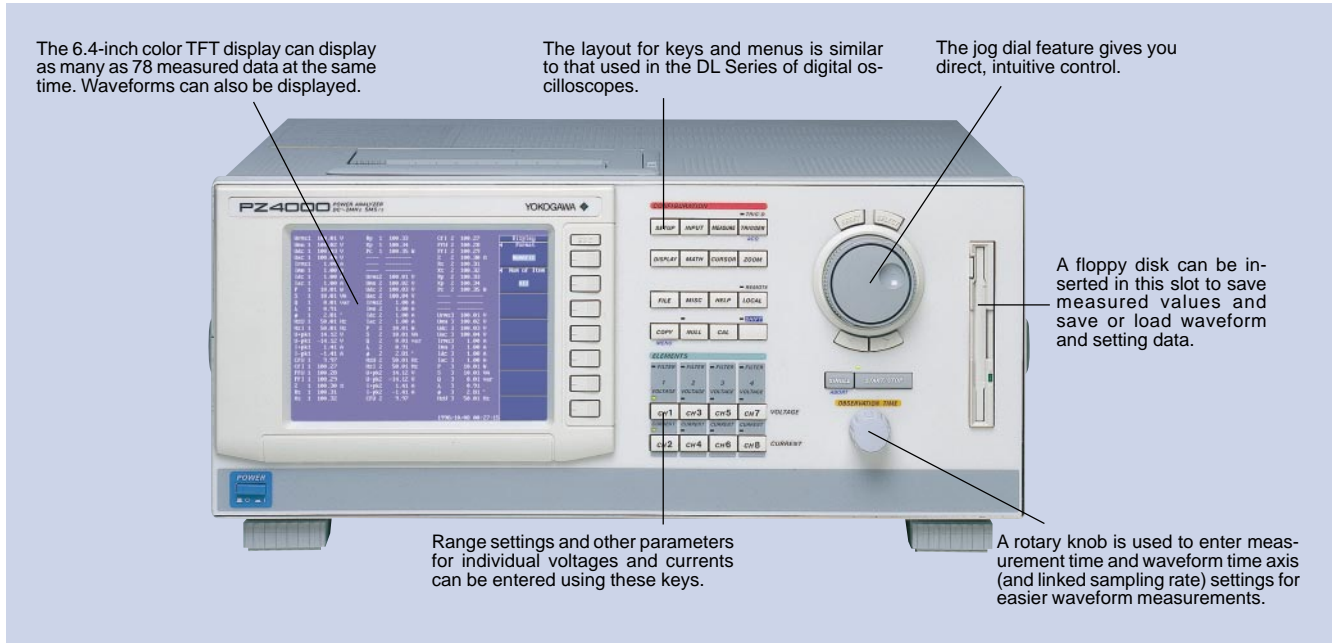

Basic performance (reference values)

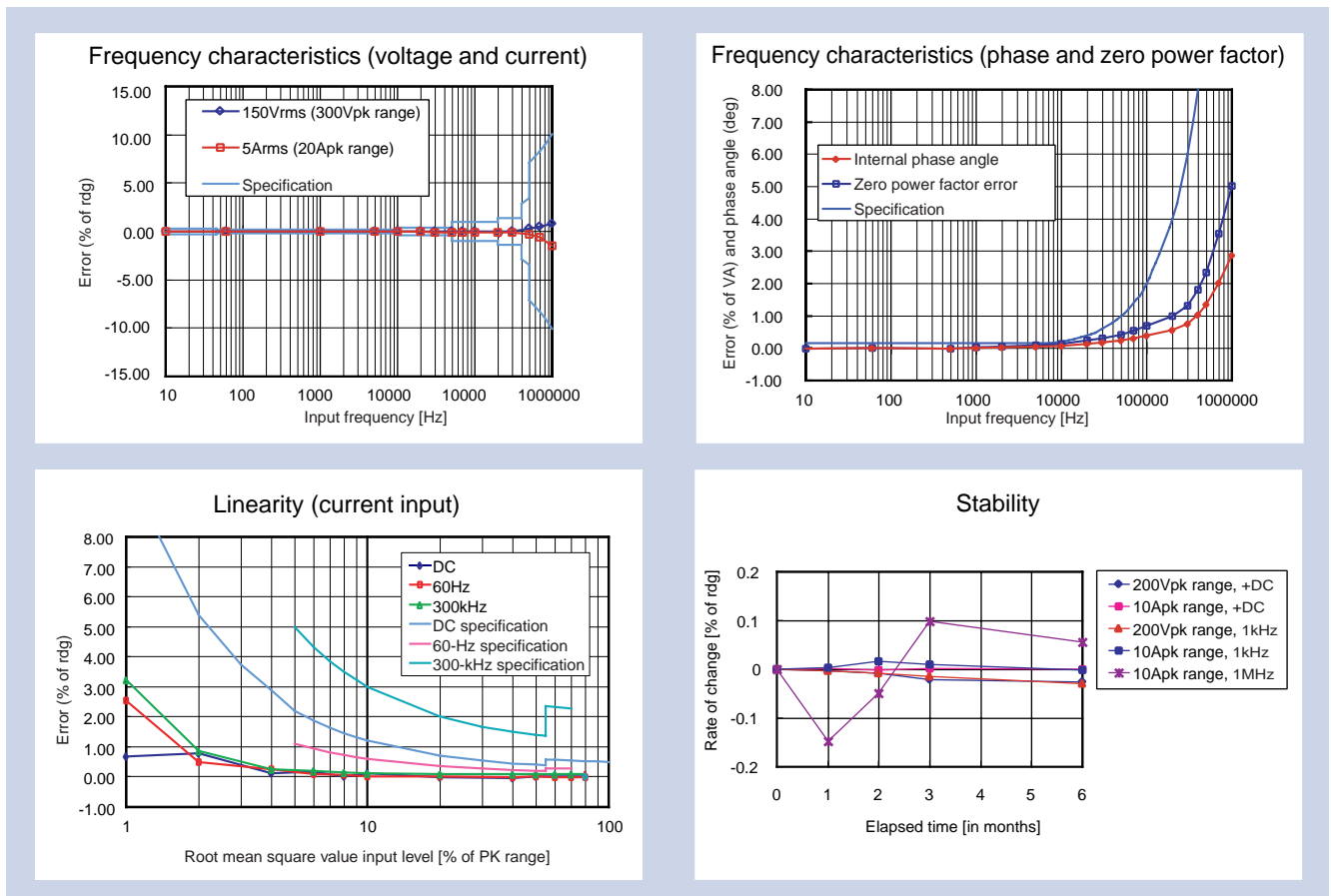

Different modules for different uses



- 253751 Power measurement module:**
 Voltage direct input ranges: 30, 60, 120, 200, 300, 600, 1200, 2000 Vpk (1000 Vrms)
 Current direct input ranges: 0.1, 0.2, 0.4, 1, 2, 4, 10 Apk (5 Arms)
 Current sensor input ranges: 0.1, 0.2, 0.4, 1 Vpk (500 mVrms)
- 253752 Power measurement module:**
 Voltage direct input ranges: 30, 60, 120, 200, 300, 600, 1200, 2000 Vpk (1000 Vrms)
 Current direct input ranges: 0.1, 0.2, 0.4, 1, 2, 4, 10 Apk (5 Arms, upper terminal)
 1, 2, 4, 10, 20, 40, 100 Apk (20 Arms, lower terminal)
 Current sensor input ranges: 0.1, 0.2, 0.4, 1 Vpk (500 mVrms)
- 253771 Sensor input module:**
- | | |
|---|--|
| Torque computing analog input | 1 / 2 / 5 / 10 / 20 / 50Vpk |
| Revolution speed computing analog input | 1 / 2 / 5 / 10 / 20 / 50Vpk |
| Revolution speed computing pulse input | Maximum input range $\pm 5Vpk$
Effective input range Min. 1Vp-p |

Back panel designed for both safety and performance

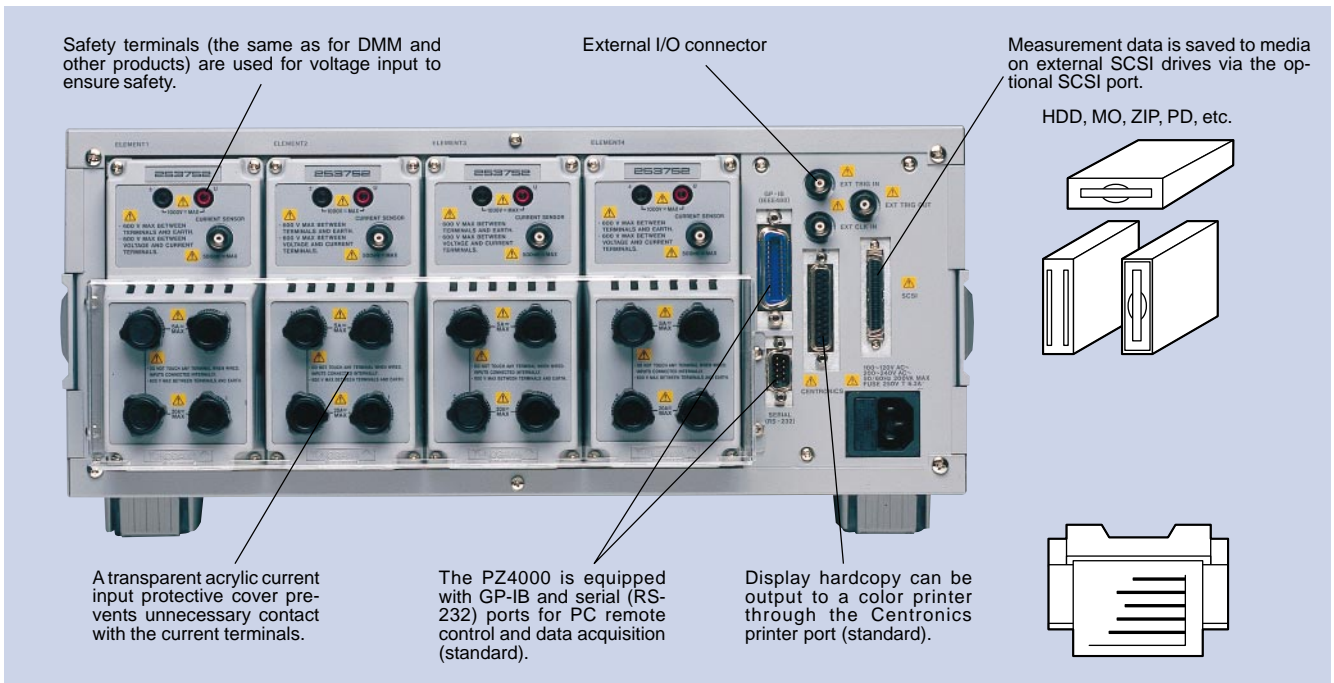

Motor evaluation function and synchronized measurements

PZ4000 with model 253771 sensor input module can measure the output from torque meter (or torque sensor with transducer for torque and rotating speed), and compute torque, rotating speed, mechanical power, synchronous speed, slip, motor efficiency and total efficiency. The PZ4000 can show torque and rotating speed as waveforms on the display. Using MATH function, the trend curve of Mechanical power and efficiency can be displayed. The PZ4000 can also show torque vs rotating speed curve on the display using X-Y display. If more than 4 inputs are required for measuring 3-phase power from an Inverter and motor, two PZ4000's can be connected, together in a master-slave configuration for up to 8 synchronized measurement channels. (Note: There is maximum difference between PZ units of 3 microseconds plus two sample points.)

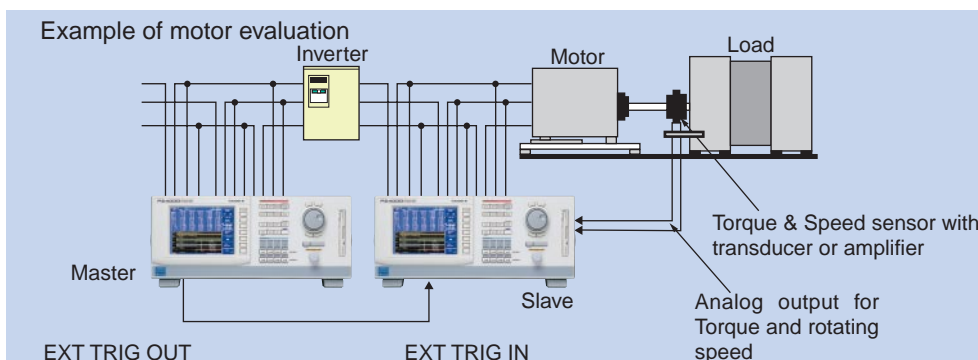

Specifications

Inputs

Type: Plug-in inputs

Slots: 4

Specifications (253751 and 253752 power measurement modules)

Input type	Voltage input	Current input
	Resistive voltage divider	Floating input
Rated values (ranges)	Direct inputs: 30, 60, 120, 200, 300, 600, 1200, 2000 Vpk (1000 Vrms)	Direct input: Shunt input External input: Resistive voltage divider
		Direct input: 5 A Apk (5 Arms)
Input resistance	Input resistance: Approximately 1 MΩ Input capacitance: Approximately 5 pF	Direct input 20 A Apk (20 Arms)
		External input: 100, 200, 400, 1000 mVpk (500 mVrms)
Instantaneous maximum allowable input (1 second)	Peak of 2000 V or rms of 1000 V (whichever is less)	253751: Combination of direct input 5 A and external input
		253752: Combination of direct inputs 5 A, 20 A, and external input
Continuous maximum allowable input	Peak of 2000 V or rms of 1000 V (whichever is less)	Direct input 5 A: Peak of 30 A or rms of 15 A (whichever is less) Direct input 20 A: Peak of 150 A or rms of 40 A (whichever is less) External input: Peak and rms of 2 V or less
		Direct input 5 A: Peak of 10 A or rms of 7 A (whichever is less) Direct input 10 A: Peak of 100 A or rms of 30 A (whichever is less) External input: Peak and rms of 2 V or less
Continuous maximum common mode voltage (50/60 Hz)	600 Vrms	
Common mode rejection ratio (600 Vrms)	Voltage input shorted and current input open 10 Hz ≤ f ≤ 1 kHz: ± 0.005% of range or less Other cases: Design value, ± ((maximum range rating) / (range rating)) × 0.0002 (f) % of range or less (f is in kHz)	
Input terminal type	Plug-in terminal (safety terminal)	Direct input: Large binding post External input: BNC
A/D converter	Simultaneous voltage and current conversion, 12-bit resolution, maximum 5 MS/s sampling rate	
Line filter	Available cutoff frequencies: OFF, 500 Hz, 20 kHz, 1 MHz	
Zero-cross filter (for HF trigger and frequency detecting for averaging)	Available cutoff frequencies: OFF, 500 Hz, 20 kHz	
Range switching	Available settings for each element: Manual, Automatic, Remote Control	
Auto-range function	Range up: When input peak exceeds 80% of range rating Range down: When input peak falls to 15% or less of range rating	

Accuracy

Accuracy (253751 and 253752 power measurement modules)

Accuracy Conditions	Voltage/current	Power
	Temperature: 23°C ± 3°C Humidity: 50% ± 10% Input waveform: Sine-wave Common mode voltage: 0 V Power factor: cosφ = 1 Within 3 months after calibration * DC accuracy is specified with NULL function on and line filter (1 MHz) on. * For at least five input signal cycles in observation time, and at least 10 k words of sampling data	
Frequencies		
DC	±(0.2% of rdg + 0.1% of rng)	±(0.2% of rdg + 0.1% of rng)
0.1 Hz ≤ f < 10 Hz	±(0.2% of rdg + 0.1% of rng)	±(0.2% of rdg + 0.05% of rng)
10 Hz ≤ f < 45 kHz	±(0.2% of rdg + 0.05% of rng)	±(0.2% of rdg + 0.025% of rng)
45 Hz ≤ f ≤ 1 kHz	±(0.1% of rdg + 0.05% of rng)	±(0.1% of rdg + 0.025% of rng)
1 kHz < f ≤ 10 kHz	±(0.1% of rdg + 0.05% of rng)	±(0.1% of rdg + 0.04% of rng)
10 kHz < f ≤ 50 kHz	±(0.2% of rdg + 0.1% of rng)	±(0.2% of rdg + 0.05% of rng)
50 kHz < f ≤ 100 kHz	±(0.6% of rdg + 0.2% of rng)	±(0.6% of rdg + 0.1% of rng)
100 kHz < f ≤ 200 kHz	±(0.6% of rdg + 0.2% of rng)	±(1.5% of rdg + 0.15% of rng)
200 kHz < f ≤ 400 kHz	±(1% of rdg + 0.2% of rng)	±(1.5% of rdg + 0.15% of rng)
400 kHz < f ≤ 500 kHz	±[(0.1 + 0.006 × f)% of rdg + 0.2% of rng]	±[(0.1 + 0.009 × f)% of rdg + 1.5% of rng]
500 kHz < f ≤ 1 MHz	±[(0.1 + 0.006 × f)% of rdg + 2% of rng]	±[(0.1 + 0.009 × f)% of rdg + 1.5% of rng]
1 MHz < f ≤ 5 MHz	±[(0.1 + 0.006 × f)% of rdg + 2% of rng]	—————
Power factor influence (f is in kHz)	10 Hz and below and 1 MHz and above are design values (1 MHz and above applies only to voltage inputs and external current sensor inputs). When input is voltage input of 400 Vrms or greater: Add [(reading error) × 1.5 × U ² % of rdg]. In addition, values of 100 kHz or greater are design values: add [(reading error) × 0.005 × f × U ² % of rdg]. When input is 10 Arms or greater in module 253752: Add [(reading error) × 0.0002 × I ²]. Units U (input voltage): kV, I (input current): A, f (frequency): kHz	
One year accuracy	Reading error (3 months accuracy) + range error (3 months accuracy) × 1.5	
Line filter effects	Add 0.5% of rdg with fc/10.	Add 1% of rdg with fc/10.
Effective input range	As per the above accuracy when the input signal is a sine wave with rms at 5 to 55% of range rating, or when the input signal is DC between -55% and 55% of measurement range. Double the above 3 months reading error when the input signal is a sine wave with rms at 55 to 70% of range rating, or when the input signal is DC between -100% and -55% or between 55% and 100% of measurement range.	
Temperature coefficient	Add 0.01% of rdg/°C (5 to 20°C, 26 to 40°C, but 10 kHz or less)	

Accuracy per sampling (instantaneous value) during cursor measurement: ±2% of rng (design value) (does not include error relating to analog bandwidth or sampling resolution)
Measurement accuracy when there are less than five input cycles and sampled data are less than 10 k words: (1/10 of reading error) × (5/(number of input signal cycles in observation time)) × (10 k words/(number of sampled data words))
Add % of rdg to 3 months accuracy (design value)
We recommend storing the PZ4000 at temperatures of 40°C or less to ensure measurements within the above accuracy specifications.

Numerical calculations

Sigma calculation formulas for different wiring types

	Single phase, 3 wires	3 phases, 3 wires	3V3A	3 phases, 4 wires
U (voltage) Ui	(U1 + U2)/2		(U1 + U2 + U3)/3	
I (current) Ii	(I1 + I2)/2		(I1 + I2 + I3)/3	
P (active power) P	P1 + P2		P1 + P2 + P3	
Q (reactive power)	Q1 + Q2		Q1 + Q2 + Q3	
S (apparent power)	S1 + S2		S1 + S2 + S3	
λ (power factor) P/S	ΣP/ΣS		ΣP/ΣS	
φ (phase angle) cos ⁻¹ (P/S)	cos ⁻¹ (ΣP/ΣS)		cos ⁻¹ (ΣP/ΣS)	

Wiring settings: Divisible into two groups

	ΣA		ΣB		Number of attached elements
	Setting	Used elements	Setting	Used elements	
1P2W (single phase, 2 wires)	1	—	—	—	1 element or more
	1	1P2W (single phase, 2 wires)	2	—	2 element or more
	1	1P3W (single phase, 3 wires)	2, 3	—	3 element or more
	1	3P3W (3 phases, 3 wires)	2, 3	—	3 element or more
	1	3V3A (3 phases, 3 wires)	2, 3, 4	—	4 element or more
	1	3P4W (3 phases, 4 wires)	2, 3, 4	—	4 element or more
1P3W (single phase, 3 wires)	1,2	—	—	—	2 element or more
	1,2	1P2W (single phase, 2 wires)	3	—	3 element or more
	1,2	1P3W (single phase, 3 wires)	3, 4	—	4 element or more
	1,2	3P3W (3 phases, 3 wires)	3, 4	—	4 element or more
3P3W (3 phases, 3 wires)	1,2	—	—	—	2 element or more
	1,2	1P2W (single phase, 2 wires)	3	—	3 element or more
3V3A (3 phases, 3 wires)	1,2,3	—	—	—	3 element or more
	1,2,3	1P2W (single phase, 2 wires)	4	—	4 element or more
3V4W (3 phases, 4 wires)	1,2,3	—	—	—	3 element or more
	1,2,3	1P2W (single phase, 2 wires)	4	—	4 element or more

Calculation display resolution

	P (active power)	Q (reactive power)	S (apparent power)	λ (power factor)	φ (phase angle)
Display range	Ratings depend on the voltage and current ranges.	Ratings depend on the voltage and current ranges. (Q ≥ 0)	Ratings depend on the voltage and current ranges.	-1 to 0 to 1	LEAD180 to 0 to LAG180 Or 0 to 360
Maximum display or maximum resolution	99999 or (selectable)	99999 or (selectable)	99999 or (selectable)	±1.0000	0.01

Note 1: The apparent power (S), reactive power (Q), power factor (λ), and phase angle (φ) for the PZ4000 are calculated based on voltage, current, and active power. (However, reactive power is measured directly during harmonic measurement.) Therefore, during distorted wave input, there may be a difference between these values and those of other measuring instruments based on different measurement principles.

Note 2: If either the voltage or current is 0.25% or less of the range rating, zero will be displayed for the apparent power (Q) and reactive power (S), and errors will be displayed for the power factor (λ) and phase angle (φ).

Note 3: If both the voltage and current are sinewaves, and there is not a great difference between voltage and current in terms of the ratio of input to measurement range, then the lead/lag phase angle φ will be correctly detected.

Note 4: There are no accuracy specifications for 0 and 180 ± 5 degrees when phase angle reading is 0 to 360.

Measurement function items:

U (voltage), I (current), P (active power), S (apparent power), Q (reactive power), λ (power factor), φ (phase angle), CF (crest factor), FF (form factor), |Z| (impedance), R_s and R_p (resistance), X_s and X_p (reactance), η and 1/η (efficiency), P_c (Corrected Power), F1 to F4 (user-defined functions)

Delta computation (during normal measurement only):

Calculated by taking the sum or difference of instantaneous voltage and current values. One of the following can be selected.

Measurement parameters: ΔU_{rms}, ΔU_{mn}, ΔU_{dc}, ΔU_{ac}, ΔI_{rms}, ΔI_{mn}, ΔI_{dc}, ΔI_{ac}

u1-u2: Voltage only

i1-i2: Current only

3-phase 3-wire/3V3A conversion

Y-Δ conversion: Phase voltage-line voltage conversion, neutral line current

Δ-Y conversion: Line voltage-phase voltage conversion, neutral line current

Waveform calculations

Parameters	Voltage and current of any element
Waveform calculations	2 types (MATH1 and MATH2)
ITEM	C1 to C8: CH1 to CH8 data
Memory size	100 k words (if MATH1 and MATH2 are both used, then 100 k words each)
Arithmetic calculations	Addition, subtraction, multiplication, division
Special functions	
AVG()	Exponential average of instantaneous value
TREND(), TRENDM(), TREND()	Average data for each cycle
When C1 to C8 are inserted	
TREND()	Root mean square values (true RMS)
TRENDM()	Rectified MEAN value converted into an RMS value (MEAN)
TREND()	Average (DC)
TRENDM()	Power average values (active power) for C1*C2, C3*C4, C5*C6, C7*C8. Only the following can be set in the parentheses: one item, C1*C2, C3*C4, C5*C6, C7*C8. (functions can not be entered in parentheses.)
TREND()	Frequency data for each cycle, when C1 to C8 is inserted.
Other functions	ABS, SQR, SQRT, LOG, LOG10, EXP, NEG, TINTG, DIF
FFT	
Type	PS (power spectrum)
Number of points	1000 points, 2000 points, 10000 points
Window functions	Rectangular, Hanning
Measured parameters	Voltage and current rms values, active power
Starting point can be specified.	

Motor Evaluation Functions (sensor input module 253771) NEW

Computing item:	torque, revolution speed, mechanical power, synchronous speed, slip, motor efficiency, total efficiency and X-Y display for these items
Torque / Revolution speed computing	analog input
Input resistance	Approx. 1MΩ, approx. 17pF
Accuracy	±0.1% of rdg + 0.05% of rng
Input range	1/2 / 5 / 10 / 20 / 50Vpk
Maximum rated input	25Vrms
Temperature coefficient	±0.03% of rdg/°C
Revolution speed computing	pulse input
Input resistance	Approx. 1MΩ, approx. 17pF
Accuracy	±(0.05% of rdg)
	Observation time need over 300 cycle pulses
Maximum input range	±5Vpk
Effective input range	Minimum 1Vp-p
Input waveform	Rectangular waveform (duty ratio 50%)
Pulse-revolution number transfer response	1 cycle of input frequency
Effective frequency range	2kHz to 200kHz (counter clock frequency 8MHz) 250Hz to 8kHz (counter clock frequency 1MHz) 16Hz to 800Hz (counter clock frequency 62.5kHz) 1Hz to 40Hz (counter clock frequency 3906.25Hz)

Note: Sensor input module 253771 can use Element 4 slot only.
Select either analog or pulse for revolution speed computing input.

Frequency measurements

Measurement type	Reciprocal
Measured parameters	Voltage and current values of all installed power measurement modules (only channels set to SYNC source during harmonic analysis).
Maximum display	99999 (2.5000 MHz max)
Accuracy	For observation period of 2 ms or longer 10 Hz ≤ f < 10 kHz ±0.1% of rdg + 1 digit Assumes sinewave with input of at least 15% of range; 5 cycles or more within observation period; and measured frequency no greater than 1/2.5 of sampling rate.
Frequency measurement filter	Set using zero-cross filter.

Harmonic measurement

Measurement type	PLL synchronization
Measured frequency range	Fundamental wave frequency range of 20 Hz to 6.4 kHz

Measured function items:

U, I, P, S, Q, λ, φ (between V and A) for each order, φ_U, φ_I (phase difference for harmonic component relative to fundamental wave), |Z|, R_s, R_p, X_s, X_p, TOTAL U, I, P, S, Q, λ (Σ calculation possible), and φ
U, I, and P harmonic distortion factor of each order
U, I, and P THD
PLL synchronization frequencies
UTHF (voltage telephone harmonic factor), ITHF (current telephone harmonic factor), UTIF (voltage telephone influence factor), ITIF (current telephone influence factor), HVF (harmonic voltage factor), HCF (harmonic current factor)

Set record length	Same as normal.
FFT data points	8192 FFT analysis data starting point in acquisition memory can be set as desired.
FFT processing word length	32 bits
Window function	Rectangular
PLL synchronization options	Either external clock or voltage/current in all installed power measurement modules can be selected. external clock can also be used without PLL. When this is done, the fundamental frequency is 1/4096 of the external clock.
PLL synchronization filter	Set using zero-cross filter.
Anti-aliasing filter	Set using line filter (fc = 20 kHz)

Relationships between sampling rate, window width, and number of analysis orders

Fundamental frequency (Hz)	Sampling rate (Hz)	Window width	Maximum number of analysis orders	Maximum number of analysis orders with accuracy equal to normal measurement accuracy
20 Hz ≤ f < 40 Hz	f × 4096	2	500	50
40 Hz ≤ f < 80 Hz	f × 2048	4	500	50
80 Hz ≤ f < 160 Hz	f × 1024	8	500	50
160 Hz ≤ f < 320 Hz	f × 512	16	200	25
320 Hz ≤ f < 640 Hz	f × 256	32	100	25
640 Hz ≤ f < 1.28 kHz	f × 128	64	50	10
1.28 kHz ≤ f < 2.56 kHz	f × 64	128	30	10
2.56 kHz ≤ f < 6.4 kHz	f × 32	256	15	-

Note 1: Hysteresis is applied across each of the above fundamental frequency bands.

Measurement accuracy Accuracy for bands where normal measurement accuracy is not applied: Add [0.001 × f × (order number)% of reading] (design value) Where f (in kHz) is the frequency for that order.

Display

Display	6.4-inch color TFT liquid crystal display
Pixel area for full display	640 × 480 (The liquid crystal display may contain approximately 0.02% defects among all display pixels.)
Pixel area for waveform	501 × 432
Display area	Numerical Normal measurement: 8 values values, 16 values, 42 values, 78 values, ALL Harmonic measurement: 8 values, 16 values, Single List, Dual List, Σ List
Waveforms	Single, Dual, Triad, Quad
Vector	Phase diagram for fundamental component during harmonic measurement
Bar	Bar graph up to maximum number of analysis orders during harmonic measurement
Simultaneous display	Numerical value + waveform, numerical value + bar, waveform + bar
X-Y display	Any one of the following can be selected for the X-axis: CH1-CH8, MATH1, MATH2. The rest of these are simultaneously displayed on the Y-axis.
Alarm display	Displayed on screen (only sensed during observation period). Peak over: When instantaneous value exceeds approximately 125% of range
Maximum number of waveform display traces	24 traces (during zooming): 8 captured waveforms + 16 zoomed waveforms
Display updating cycle	Depends on the observation time and record length. The display updating cycle is approximately 2 seconds in normal measurement mode, using a 100 ms observation time, 100 k word record length setting, and 8 channels, with numerical value calculation ON and waveform calculation off. The display updating cycle is approximately 2 seconds in harmonic measurement mode, using a 100 ms observation period, 100 k word record length setting, and 8 channels, with numerical value calculation ON and waveform calculation off.

Memory

Set record length	100 k word/CH (standard), 1 M word/CH (with /M1 option), 4 M word/CH (with /M3 option)
Record length settings	100 k word, 1 M word, 4 M word (or 50 k word, 500 k word, and 2 M word when record length is divided; screen data are saved and measurement is ended when the STOP button is pressed) The sampling rate is selected automatically when the record length and observation time are set.

Triggers

Modes	Off, Auto, Auto Level, Normal, and (with edge trigger) HF Auto, HF Normal
Types	Edge, window
Sources	INT (channels 1 through 8), and (with edge trigger) EXT
Slopes	Rising, falling, both
Trigger position	0% to 100% HF cutoff frequency: set using zero-cross filter. When HF is selected as the trigger mode, the trigger level cannot be set.

Screen data output and saving (copying)

Internal printer (optional) Screenshot hard copies
Floppy disks and external SCSI devices (optional) Formats: PostScript, TIFF, BMP
Centronics port Formats: ESC-P, ESC-P2, LIPS3, PR201, PCL5, BJ

External I/O

EXT TRIG IN (external trigger input)	
Connector	BNC
Input voltage	CMOS level (L: 0 to 1 V, H: 4 to 5 V)
Minimum pulse width	1 μs
Trigger delay time	(2 μs + 1 sample cycle) or less
EXT TRIG OUT (external trigger output)	
Connector	BNC
Input voltage	CMOS level (L: 0 to 1 V, H: 4 to 5 V)
Output delay time	(1 μs + 1 sampling cycle) or less
Output holding time	Low level 200 ns or longer
EXT CLK (external sampling clock input)	
Connector	BNC
Input voltage	CMOS level (L: 0 to 1 V, H: 4 to 5 V)
Input frequency range	1 kHz to 250 kHz (50% duty)
20 Hz to 6.4 kHz when used as PLL source for harmonic analysis.	4096 times the fundamental frequency when used as a sampling clock for harmonic analysis. (The external clock is internally sampled at 20 MHz.)
Internal floppy drive	
Size	3.5 inches
Formats	640 KB, 720 KB, 1.2 MB, 1.44 MB

GPIB port
 Electrical and mechanical specifications
 Functional specifications
 Protocol
 Serial (RS-232) port
 Connector
 Standard
 Bit rates
 Centronics port
 Connector
 SCSI port (optional)
 Standard
 Connector
 Connector pin assignment
 Usable hard drives
 Usable MO drives
 Other drive types
 For further information, please contact your nearest YOKOGAWA dealer.

General specifications
 Warmup time
 Operating temperature and humidity ranges
 Storage temperature range
 Maximum operating altitude
 Insulating resistance
 253710
 253751, 253752
 253771
 Withstand voltage
 253710
 253751, 253752
 253771
 253751, 253752
 253771
 Rated supply voltages
 Allowed supply voltage fluctuation ranges
 Rated supply frequencies
 Allowed supply frequency fluctuation range
 Consumed power
 External dimensions
 Weight

Dimensions (PZ4000)

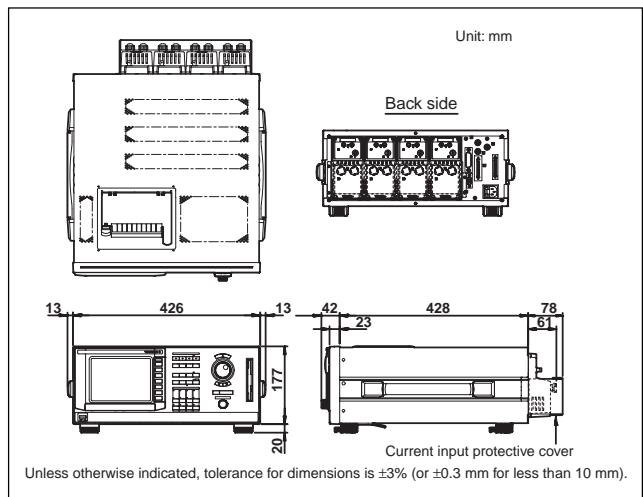

Recording

Internal printer (optional)	
Printing method	Thermal line-dot printing
Dot density	8 dot/mm
Paper width	112 mm
Effective recording width	104 mm
Recording speed	Maximum 20 mm/s

Models and suffix codes

Main unit

Model	Suffix Code	Description
253710		PZ4000 Power Analyzer
Power cord	-D	UL/CSA Standard
	-F	VDE Standard
	-R	SAA Standard
	-Q	BS Standard
Options	/M1	Memory extension to 1 M word/CH
	/M3	Memory extension to 4 M word/CH
	/B5	Built-in printer
	/C7	SCSI interface

Plug-in modules

Model	Suffix Code	Description
253751		Power measurement module Voltage: 1000 V Current: 5 A Current sensor: 500 mV
253752		Power measurement module Voltage: 1000 V Current: 5 A and 20 A Current sensor: 500 mV
253771 *		Sensor input module Torque / Revolution speed input
Module specifications	-E1	Plug-in unit

* Sensor input module can be used element 4 slot only.

PZ4000 version up kit

Product	Model	Description
Version up kit	253732	For sensor input module

Note: When you have already bought PZ4000 main unit and want to buy 253771 sensor input module, you must order 253732 version up kit plus 253771 module. When you buy both main unit and sensor input module you don't need to buy 253732.

Accessories (sold separately)

Product	Model or part number	Description	Order quantity
Rack mounting kit	751535-E4	For EIA	1
Rack mounting kit	751535-J4	For JIS	1
BNC cable	366924	BNC cable BNC-BNC, 1 m	1
BNC cable	366925	BNC cable BNC-BNC, 2 m	1
BNC cable	366926	BNC-alligator clip cable	1
Conversion adapter	366971	9-pin*1/25-pin*2 conversion adapter	1
Measurement lead	758917	75 cm, two leads (red and black) in a set	1
Fork terminal adapter set	758921	4 mm fork terminal, banana terminal conversion, red and black (one each)	1
Alligator clip adapter (rated for 300 V)	758922	Banana-alligator conversion, two in a set	1
Alligator clip adapter (rated for 1000 V)	758929	Banana-alligator conversion, two in a set	1
Fuse	A1354EF	250 V, 6.3 Arms, time lag 100 V/200 V common	2
Input cable	B9284LK	For external input, 50 cm	1
Current input protective cover	B9315DJ	Acrylic current input protective cover	1
Printer roll chart	B9850NX	Thermal paper, 30 meters (one roll equals one unit)	5

*1: EIA-574 standard
 *2: EIA-232 standard (RS-232)

NOTICE

- Before operating the product, read the instruction manual thoroughly for proper and safe operation.
- If this product is for use with a system requiring safeguards that directly involve personnel safety, please contact the Yokogawa sales offices.



YOKOGAWA ELECTRIC CORPORATION
 Measurement Sales Dept./Phone: 81-422-52-6614, Fax: 81-422-52-6624
 Recorders · DAC Sales Dept./Phone : 81-422-52-6765, Fax : 81-422-52-6793

YOKOGAWA CORPORATION OF AMERICA Phone: 770-253-7000, Fax: 770-251-2088
YOKOGAWA EUROPE B.V. Phone: 31-33-4-641611, Fax: 31-33-4-631202
YOKOGAWA ENGINEERING ASIA PTE. LTD Phone: 65-783-9537, Fax: 65-786-6650

Subject to change without notice.
 [Ed : 02/b] Copyright ©1999
 Printed in Japan, 003(YG)