

Reliable Power Meters Power Recorder

Full Disclosure™ monitoring for the most comprehensive power quality studies

Technical Data



Every measurement, every event, on every cycle, all the time – without thresholds

Full Disclosure Technology is part of all Fluke and RPM three-phase power quality tools. It makes the power recorder a unique, professional instrument that increases your ability to maintain and troubleshoot your plant's power quality.

Full Disclosure Technology uses patented sampling hardware and algorithms to record everything your loads see.

- The sampling system processes every cycle on all channels, recording min/max/avg values and looking for sags, swells, or transients.
- The system can store 6000 events (up to 96,000 with Multisession Option). You can see everything from sub-cycle events to long-term outages with clear detail.
- Records power parameters, rms voltage, rms current, harmonics, flicker and monitors for power quality events – on all channels simultaneously without having to reconfigure.
- No need to set thresholds. You won't be disappointed by missed events or a memory full of noise.
- Because there are no thresholds to set, Full Disclosure technology system records any changes in measurements, even the ones that are **almost** out of tolerance

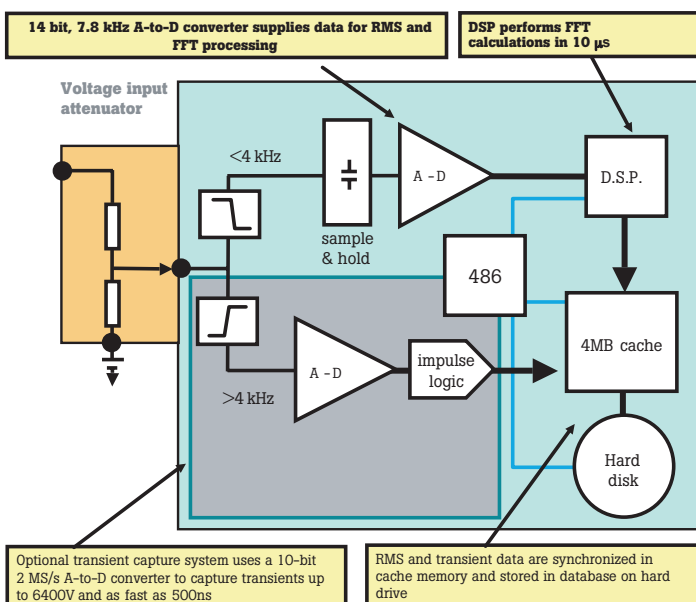

Power Recorder Architecture

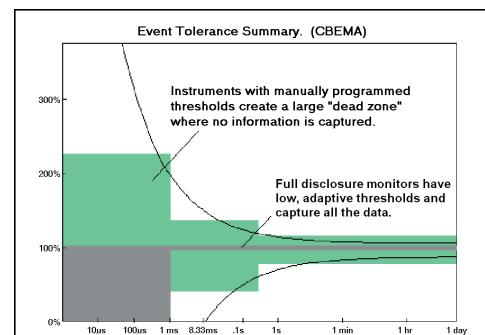

Full Disclosure technology captures thousands of voltage events and related current information, without having to set thresholds.

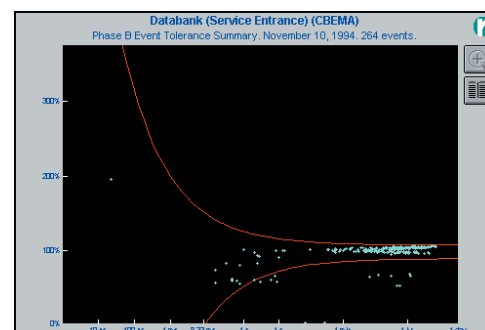

Full Disclosure technology lets you plot events on any power tolerance curve. CBEMA, ITIC, and ANSI curves are included, or create your own.

The choice of the PQ professional

- 5 Current channels allow you to monitor neutral and ground current in addition to phases
- Extruded metal enclosure is designed to handle a lifetime of use
- Ethernet interface makes downloads fast and easy
- Multi-session option multiplies event capture capability to 96,000 events.
- Power Recorders are configurable, so you can expand their capabilities to meet your growing needs.
- Use Report Writer software on your PC to automatically create power quality surveys with text and graphics.
- Polling and Alarms software allows you to configure and monitor multiple instruments, retrieve data periodically, and set up alarms to notify operators of events.

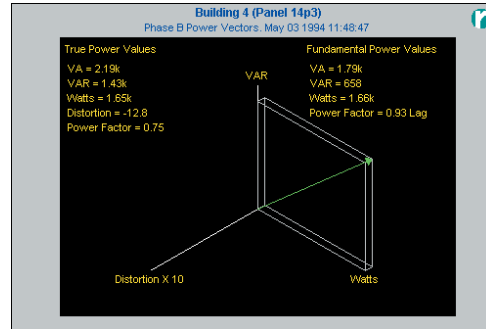

With 1652 option, real-time meter and vector diagram displays Watts, VA, VAR, PF and dPF.

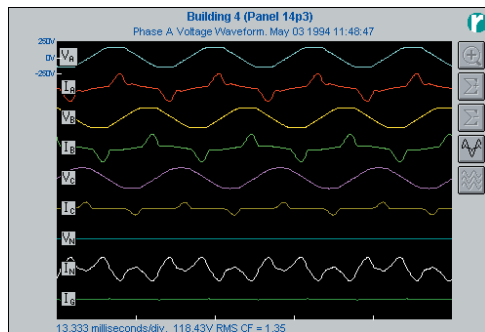

Real-time waveform displays show up to 9 channels (4 voltage, 5 current) including ground and neutral current.

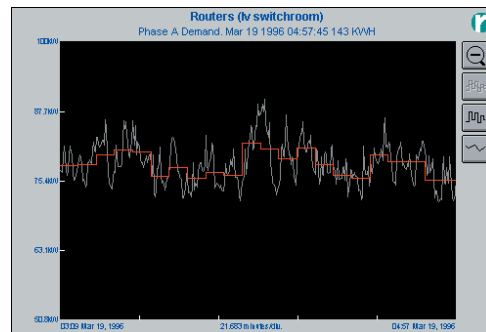

With 1652 option, you can track demand using averaging intervals from 5 minutes to 1 hour.

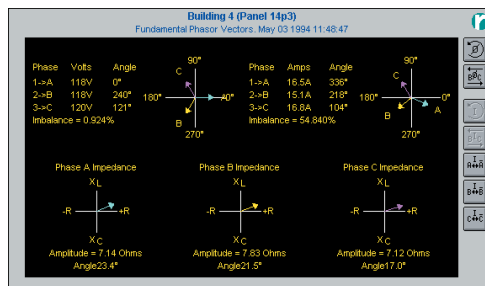

Real-time voltage and current meters feature phasor diagrams to help with correct hookup.

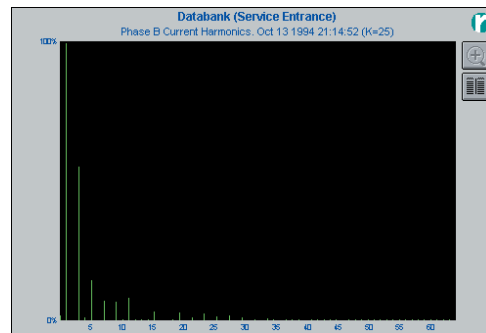

With 1653 option, you can display harmonics up to the 63rd as a spectrum or table.

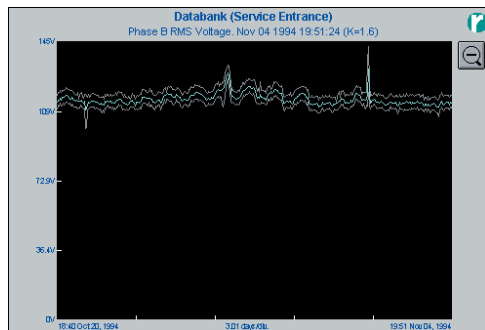

Trend windows give you an overview of power parameters – fast. Measurements are processed for every cycle. Min, max and average values are plotted so you can quickly see the worst-case.

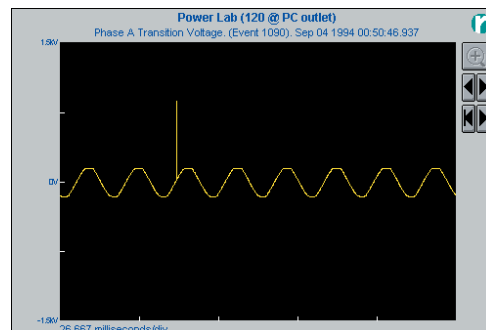

With the 1658 High-speed Power Quality Option you can capture and view transients as short as 500 ns.

	Measurement Features
All Power Recorders	<ul style="list-style-type: none"> • Logging RMS voltage and RMS current on all channels • Phasor diagrams • Frequency trends • Real-time oscilloscope display of voltage and current on all channels
1652 Power Consumption Option	<ul style="list-style-type: none"> • Watts and demand trends • KWH, individual phases and total • VA and VAR trends • Power Factor trends, true and displacement • Oscilloscope display of power meters for each phase
1653 Harmonics and Flicker Option	<ul style="list-style-type: none"> • Voltage and current THD trends • Voltage and current imbalance • Harmonic spectrum, phase, magnitude to 63rd harmonic • Tracking of individual harmonics • Flicker
1651 Power Quality Option	<ul style="list-style-type: none"> • Voltage waveshape faults as short as 130 µs duration, 1000 V peak • Voltage sags/swells • Simulations current corresponding to correlated with voltage events • Power tolerance curves
1658 High Speed Power Quality Option	<ul style="list-style-type: none"> • Voltage and current waveshape faults • Voltage and current sags/swells • Power tolerance curves • Transients as short as 500 ns duration, 6400 V peak; with peak detect or detailed waveform graphs
1662 Multi-Session Option	<ul style="list-style-type: none"> • Allows a recorder to store up to 16 measurement sessions • Each session can consist of up to 6000 events, increasing the event storage to 96,000
1663 TCP/IP Option	<ul style="list-style-type: none"> • Enables Ethernet-equipped instruments to communicate via Internet

Software completes the system

There are two software packages available for the Power Recorder. Both packages handle seamless communication with the Power Recorder, graphical display of power system parameters, and data management tools.

The Power Analyzer System software package

- Offers optional Report Writer Software
- Offers Alarming and Polling Option

Scenario Software

- Allows plotting multiple measurement sessions on one timescale
- Includes facilities for comparing trends from multiple databases
- Calculates a Power Quality Index - a single figure of merit that characterizes the overall performance of a power system. The Power Quality Index allows you to trend system performance over time and determine whether a system is improving or degrading.

Specifications

Number of channels: 9 (4 voltage, 5 current)

Function	Range	Resolution	Accuracy ±(% of reading + floor)
Voltage (phases)	100 mV - 600 Vrms 1000 V peak impulse	14 bits, 90 millivolts	± (1.5 % +0.5 V) over entire range
Voltage (neutral)	10 mV- 70 Vrms	100 V peak	14 bits, 90 millivolts
Current	Depends upon CT	14 bits	± (0.5 % + 0.1 % of probe range + probe uncertainty)
Nominal fundamental frequency	50/60 Hz ± 0.1 Hz		

Voltage and current sampling: 128 samples per cycle on 50/60 Hz
 Voltage and current sampling rate: 6.4/7.7 kS/s depending upon line frequency
 Voltage and current rms measurements: Processed for every full cycle
 Power Measurements: W, VA, VAR, PF, dPF processed for very full cycle

Impulse measurements (Standard-speed unit with option 1651)

Function	Range	Resolution	Accuracy ±(% of reading + floor)
Sampling rate	6.4 / 7.7 kS/s depending upon line frequency		
Impulse Voltage	200 - 1000 V peak	10 bits, 12 volts	± (5% +36V) over entire range

Impulse measurements (High-speed unit)

Function	Range	Resolution	Accuracy ±(% of reading + floor)
Sampling rate	2 MHz		
Impulse Voltage	200 - 6400 V peak	10 bits, 12 volts	± (5% +36V) over entire range

Note: Option 1658 adds high-speed waveform capture in addition to high-speed peak detect

Event memory: 6,000 simultaneous voltage and current events (96,000 with option 166Z)
 Communication: 10-base T Ethernet, RJ 45 connector (also available with Parallel interface); Optional TC/PIP Stack enables communication via Internet

Electrical

Safety: 600 V CAT III
 Operating voltages: 85-264 VAC, 47 - 440 Hz; 10 - 15 V DC with 4250 or 4255 optional cable
 Power consumption: 40 watts
 Batteries: NiCd battery recharges automatically while line power is applied. Power the instrument for 5 minutes after power is removed and allows controlled shutdown of monitor. Monitoring resumes after power is restored.

Mechanical

Available enclosures:
 Standard enclosure
 Hostile environment enclosure
 Size: 8.5" x 12" x 3" (21.25 cm x 30 cm x 7.5 cm)
 Weight: 13 lbs. (6 Kg)
 Operating temperature:
 0° - 50 °C (32° - 122 °F), 90% RH non-condensing

Standards

UL3111
 IEC 868

Included accessories

All units include user manual, line cord, 5 voltage leads and 5 alligator clips. Units with Ethernet interface include a 10 ft ethernet cable, socket-socket adapter, and 2-ft cross-over cable. Parallel units include a parallel cable

Configuration

Model Number	Enclosure	Computer Interface	Sampling System	Installable Options					
				PQ Measurements	Harmonics & Flicker	Power Consumption	Impulse Waveform	Multi-Session Software	TCP/IP Stack
				1651	1652	1653	1658	1662	1663
1650-56	Standard	Ethernet	High-speed	included	•	•	•	•	•
1650-50	Standard	Ethernet	Standard	•	•	•		•	•
1650-15	Hostile	Ethernet	High-speed	•	•	•	•	•	•
1650-51	Hostile	Ethernet	Standard	•	•	•		•	•
1650-10	Hostile	Parallel	High-speed	•	•	•	•	•	
1650-11	Hostile	Parallel	Standard	•	•	•		•	

Accessories

4001	Carry Bag, W/Rpm Logo
4003	Shipping Caddy With Wheels
4005	Shipping Container, Reusable
4006	6 Ft Steel Lockable Security Cable
4008	Monitor Brackets for Wall-Mounting
4250	DC Power Cable, Hostile Environment Enclosure
4255	DC Power Cable, Standard Enclosure
3014R	40 Amp Clamp
3100R	1000 Amp Clamp
3110/RPM	24-inch 100 Amp Flexi-Ct (tm)
3112/RPM	48-inch 100 Amp Flexi-Ct
3120R	200 Amp Current Clamp
3210/RPM	24-inch 1000 Amp Flexi-Ct
3212/RPM	48-inch 1000 Amp Flexi-Ct
3300R	3000 Amp Clamp
3310/RPM	24-inch 5000 Amp Flexi-Ct
3312/RPM	48-inch 5000 Amp Flexi-Ct
3602/RPM	Battery Type Voltage Probe, Set Of 5 Clips
3605/RPM	Syringe Stud Type Voltage Probes, 5 Probes
3606/RPM	Threaded Stud Type Voltage Probe, 5 Probes
3607/RPM	Bus-bar Voltage (F-Type) Probe, Set Of 5
3608/RPM	Plunger Type Voltage Probe, 5 Syringe-Action
5000/RPM	Power Analysis Software with User Manual
5100/RPM	Professional Report Writer Software (requires 5000/RPM)
5400/RPM	Scenario Analysis Software
5500/RPM	Master Polling And Annunciation Software (requires 5000/RPM)
5502/RPM	Sub-Polling And Annunciation Software (requires 5000/RPM and 5500/RPM)

**Reliable Power Meters
 A Fluke Company**

PO Box 9090, Everett, WA USA 98206

Fluke Europe B.V.
 PO Box 1186, 5602 BD
 Eindhoven, The Netherlands

For more information call:
 In the U.S.A. (800) 443-5853 or
 Fax (425) 446-5116
 In Europe/M-East/Africa (31 40) 2 675 200 or
 Fax (31 40) 2 675 222
 In Canada (800) 36-FLUKE or
 Fax (905) 890-6866
 From other countries +1 (425) 446-5500 or
 Fax +1 (425) 446-5116
 Web access: <http://www.reliablemeters.com>