

Discover What's Possible™

Anritsu

# MT9080 Series

## ACCESS Master™

1.31/1.49/1.55/1.65  $\mu\text{m}$  (SM)

Simulated screen-not actual image

**All-New Field OTDR with Integrated Functions for Installing FTTx Optical Fiber and System Maintenance with One Unit**

No.	Dist (m)	Type	Splice (dB)	R. Loss (dB)	T. Loss (dB)
01	10798.36m	Fiber End	13.918	4.437	
02	8926.16m		0.754	42.198	3.053
03	2456.50m		0.196	**	0.697

- **SM/1310/1490/1550/1650 nm OTDR for installing and maintaining optical fibers**
- **Full support for FTTx (FTTB, FTTC, FTTH, PON) fibers**
- **Short 1 m dead zone (event)**
- **Optical power meter / Optical light source for fiber identification**
- **Built-in IP network connection check function**

## Effective Functions for Installing and Maintaining Optical Fibers



### Simple operation

Necessary measurements and functions are selected and operated from the Top Menu.

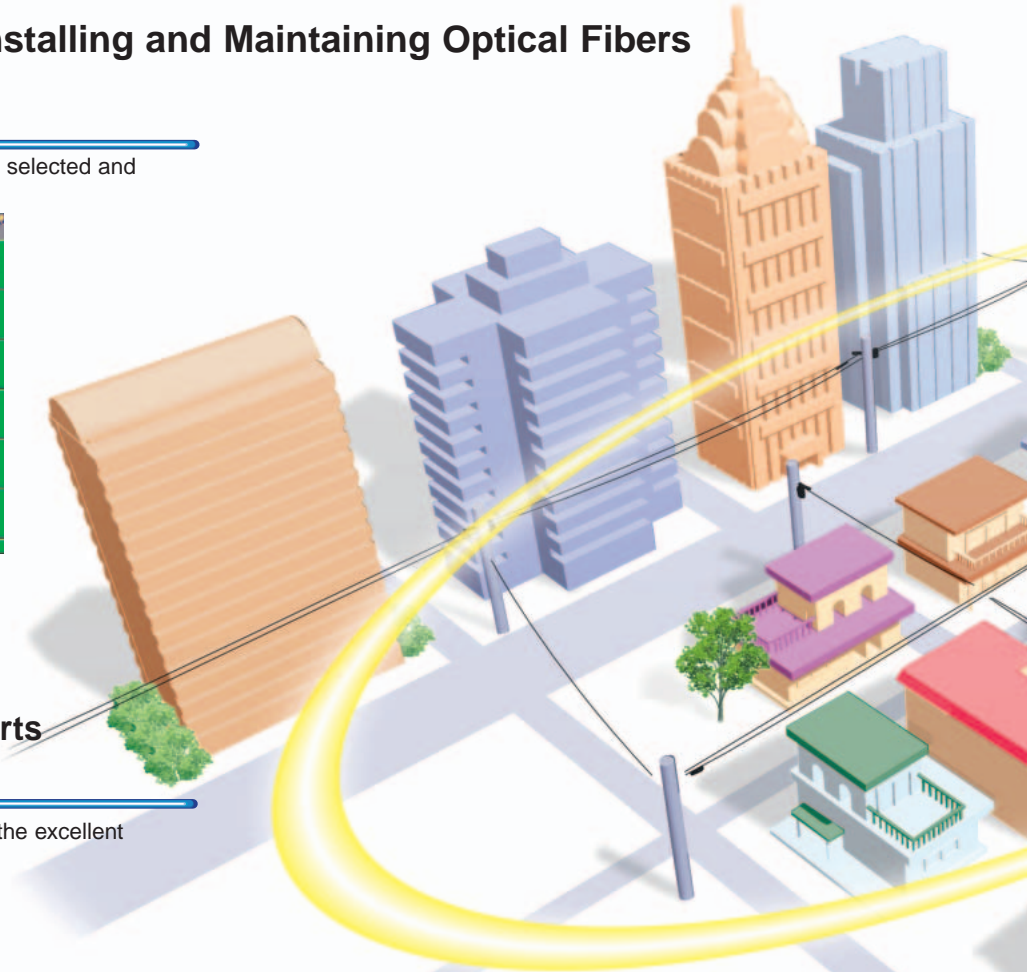

### Dynamic range supports FTTx evaluation

FTTx optical fibers can be evaluated due to the excellent dynamic range of the OTDR.



### Short dead zone: 1 m (event)

The high resolution is especially for installing and maintaining FTTx fiber now coming into wide spread use.

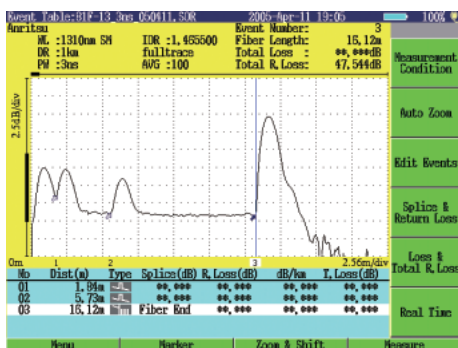

### Optical power meter, optical light source for fiber identification and visible light source

The MT9080 Series has an optical power meter and light source for fiber identification as well as a visible light source option to support troubleshooting and fiber maintenance.



Network advances are imposing increasingly higher demands on the functions and performance of field measuring instruments. Optical access using FTTH, Gigabit Ethernet, FTTC and FTTP is becoming increasingly common as ISPs start installing broadband fiber to the home. Since most of today's optical fiber networks are installed by metro and access providers, more compact easy-to-use high cost-performance measuring instruments will be required instead of the present expensive high-performance instruments that can only be used by expert network engineers. The MT9080 Series ACCESS Master is just the ideal compact OTDR for installing and maintaining FTTH optical fibers. It has the following functions:

- Weights just 2.2 kg for easy field portability
- Built-in OTDR, optical power meter and optical light source for fiber identification functions as well as optional visible light source for finding fiber faults with ease
- Short 1 m dead zone for effective evaluation and troubleshooting of short fiber runs
- Excellent dynamic range supporting installation and maintenance of FTTH fibers
- Simple menu-based GUI operation

Furthermore, in addition to optical fiber maintenance applications, the MT9080 Series ACCESS Master has an optional built-in IP network connection check function that can be used to check the IP connection, a function that previously required a PC and IP tester. Just one MT9080 Series ACCESS Master is all that is needed to perform quick and comprehensive fiber maintenance and troubleshooting, greatly cutting job time.



### Built-in IP network connection check function

Just one ACCESS Master is all that is needed for every job ranging from simply checking the network connection using the optional network connection function to full fiber troubleshooting and maintenance.

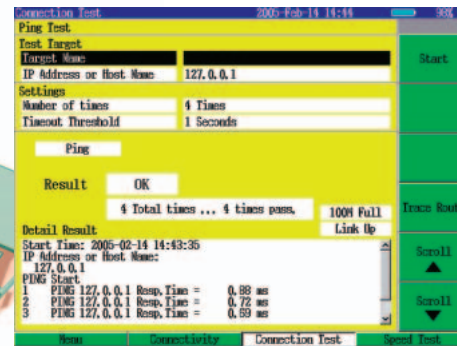

### Compact and lightweight

Compared to the traditional MW9076 Series, the ACCESS Master is more compact and light-weight for easy field use.





# MT9080 Series ACCESS Master

- 1 Function keys
- 2 Panel keys
- 3 Battery pack
- 4 Measurement port for IP network connectivity check function  
An Ethernet cable is connected.
- 5 OTDR, power meter and light source connector (1.65 μm)  
OTDR, optical power meter and optical light source use the same connector.
- 6 OTDR, power meter and light source connector (1.31/1.49/1.55 μm)  
OTDR, optical power meter and optical light source use the same connector.
- 7 USB port  
External USB flash memory can be connected to this port and the internal memory can be read/written by connecting a PC using a USB cable.
- 8 Visible light source (Option)  
Uses red LD.
- 9 AC adapter connector

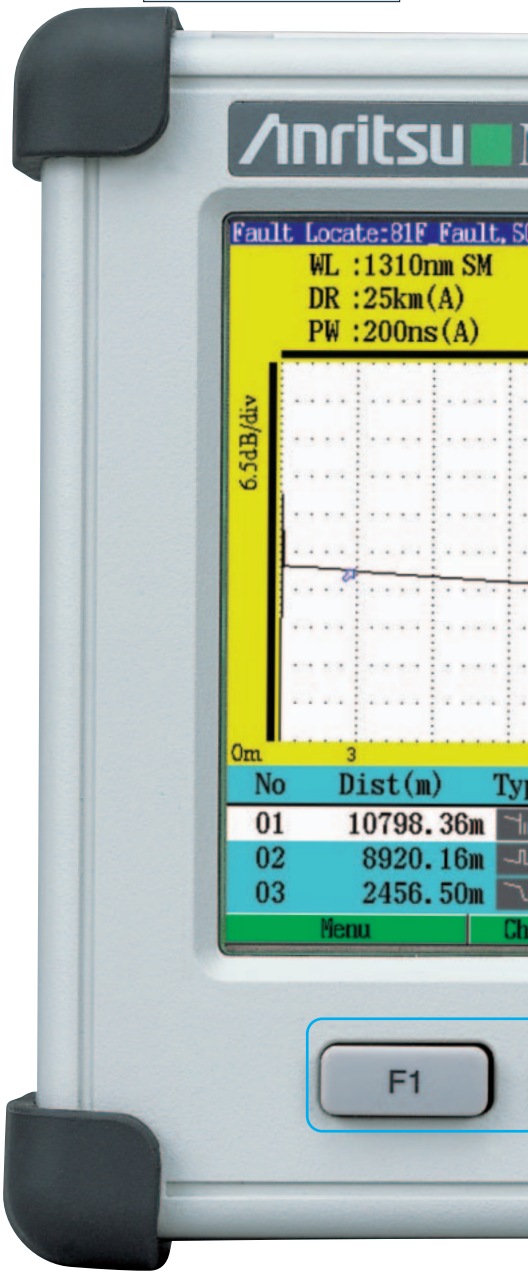

Attachment of the protector option makes carrying and operation easier. (This option includes a shoulder strap and protective cover.)



Protective cover

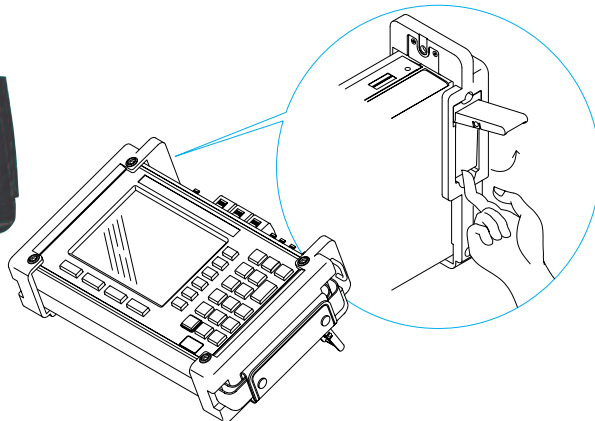

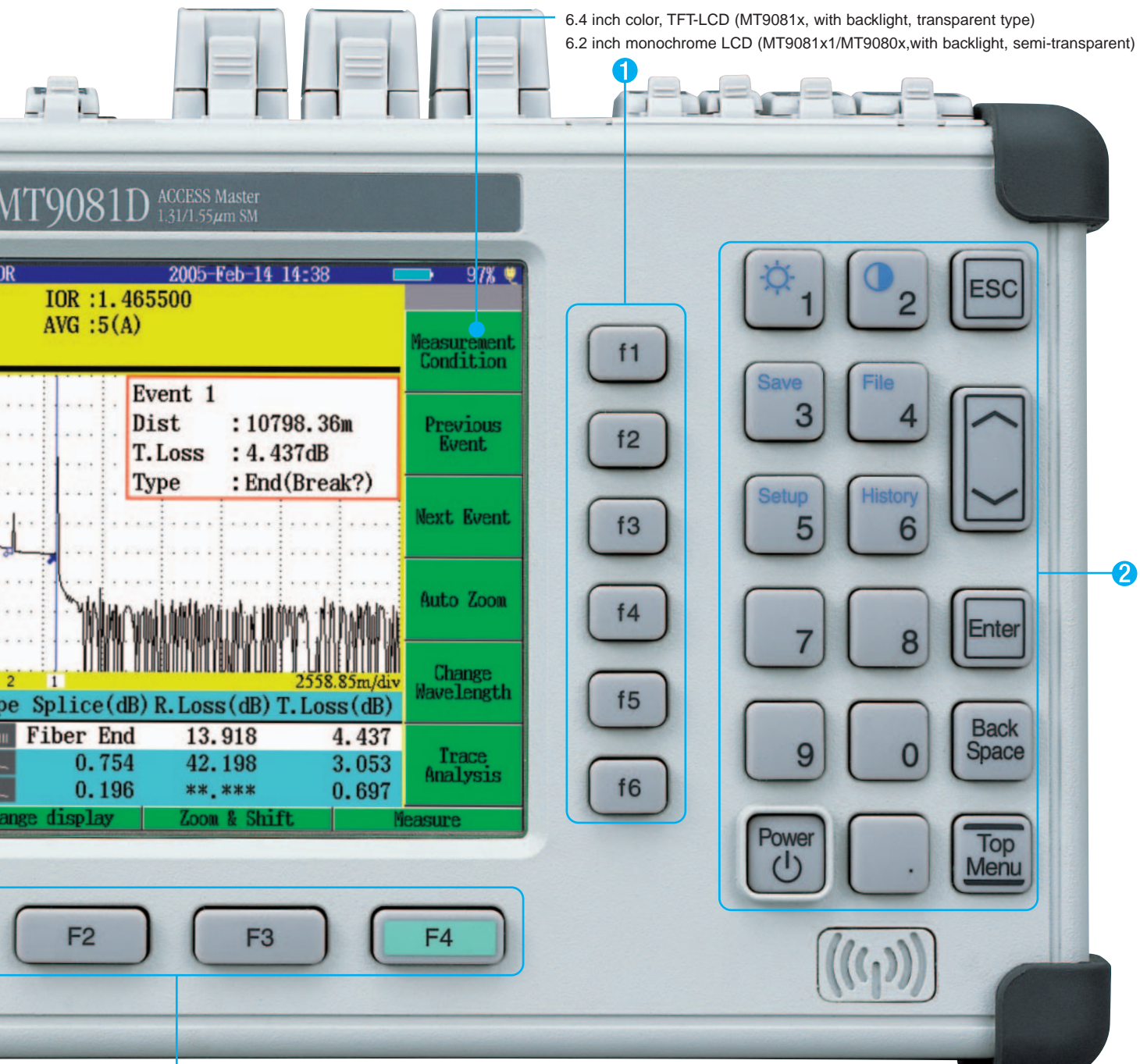

254 (W) x 162 (H) x 61 (D) mm, 2.2 kg (Including Battery pack)

Simulated screen - not actual image

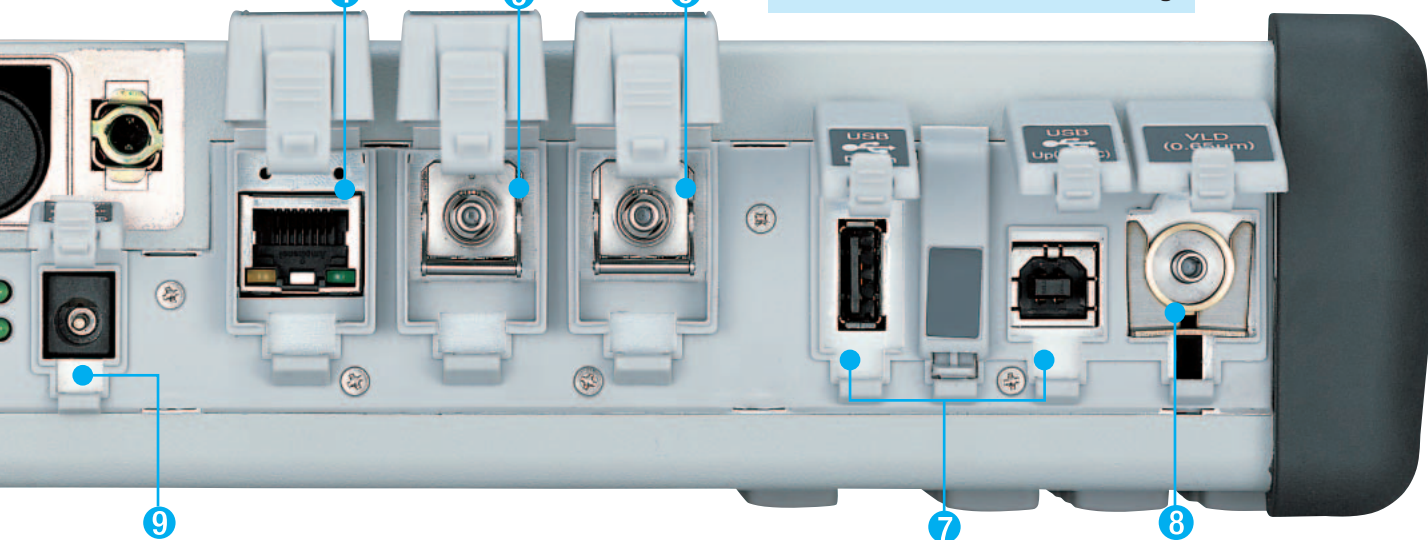



# User-Friendly and All-in-One Operation

- **Simple operation from top menu**

The Top Menu is displayed first at power-on and can be fetched at any time by pressing the Top Menu panel key, ensuring simple operation at every stage.

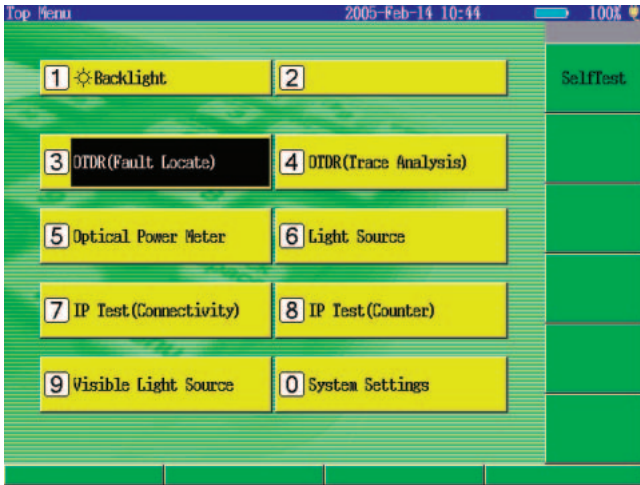

- **Easy fault location with enhanced maintenance functions**

When a fault occurs, it must be located as quickly as possible. The ACCESS Master failure identification mode locates faults easily by sending measurement pulses at the touch of a button and instantly displaying the fault location on-screen.

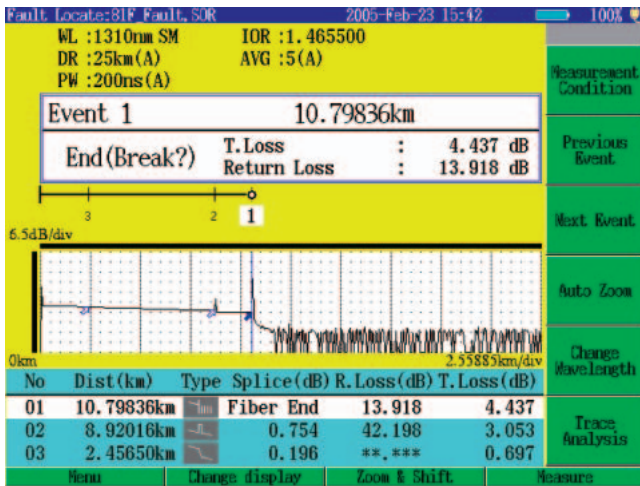

- **Optical power meter and optical light source for fiber identification functions plus visible light source option**

The ACCESS Master is designed for optical fiber installation and maintenance. It has an optical power meter, an optical light source for fiber identification and an optional visible light source to provide complete support for easy fiber installation and maintenance in a single compact package.

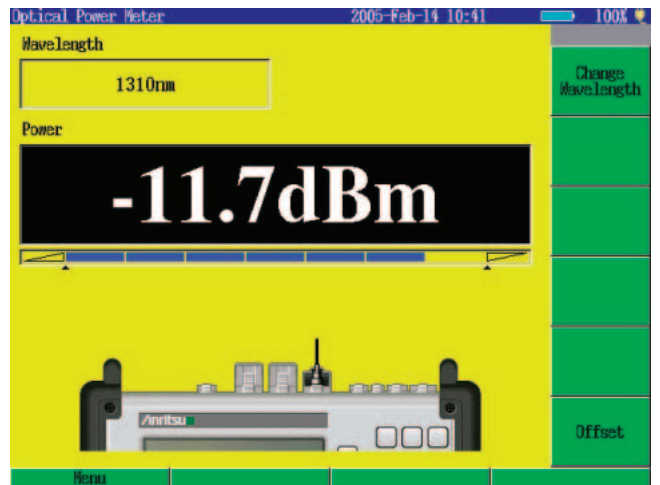
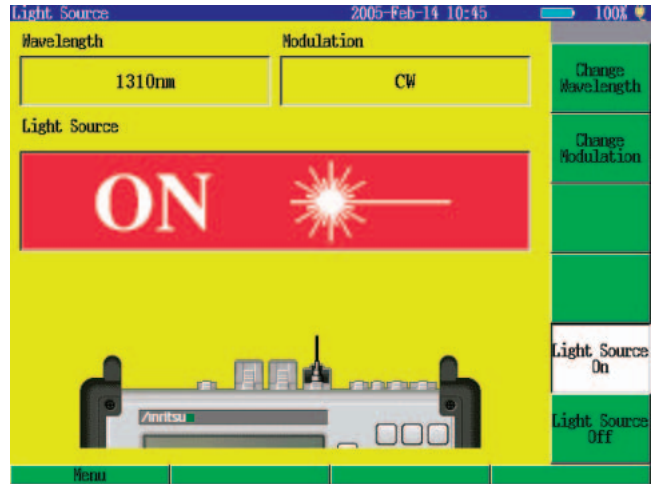

# Short Dead Zone

## ● 1 m dead zone (event) supporting FTTx

The high-performance ACCESS Master has an event dead zone of 1 m as well as a sampling resolution of 5 cm, making it the ideal OTDR for analyzing and identifying hard-to-locate in-building faults.

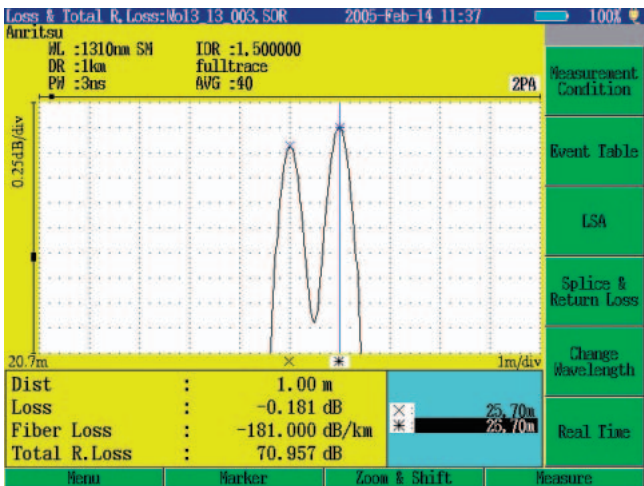
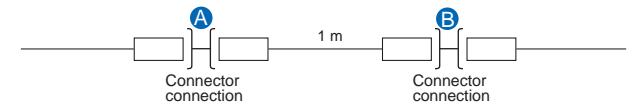
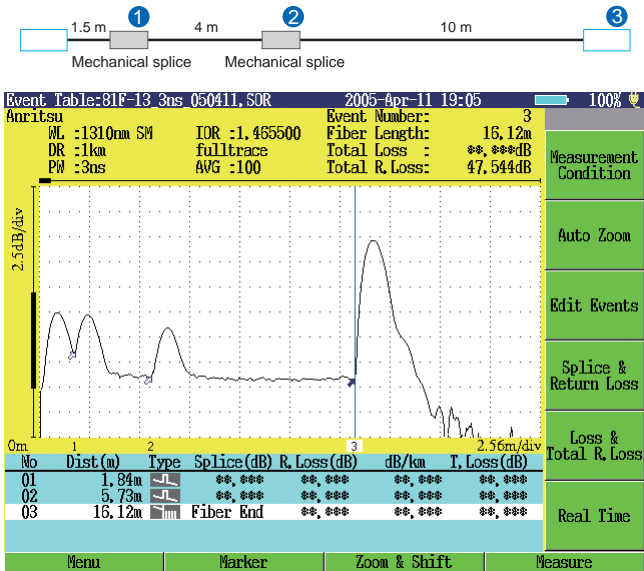

## ● Shorter dead zone than traditional mini-OTDR

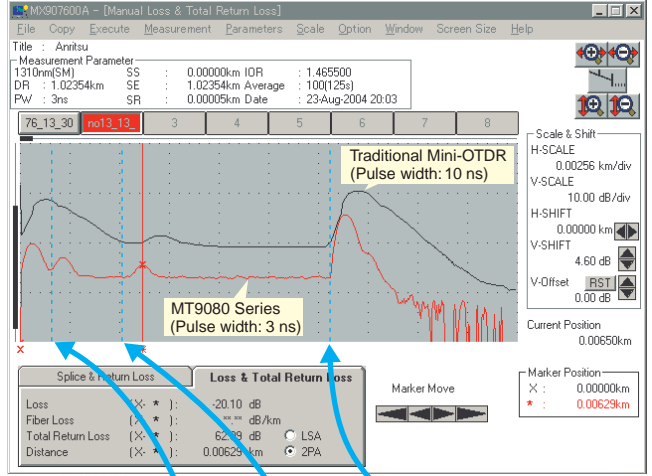

# Compact, Lightweight, and Convenient

## ● Dynamic range supporting FTTx

The MT9080 series includes the MT9080x (x: A to F) with a dynamic range of 26.5 dB (at a pulse width of 1.31  $\mu$ m) and the MT9081x/x1 (x: A to G) with a wide dynamic range of 38.5 dB (at a pulse width of 1.31  $\mu$ m)

The MT9081 models use either a transparent color LCD (MT9081x) that is optimized for best viewing indoors, or a semi-transparent monochrome LCD (MT9081x1) optimized for best viewing outdoors. (The MT9080x uses the semi-transparent monochrome LCD.)

The MT9080x has the dynamic range needed for installing and maintaining access optical fiber networks and can be used for measurements of up to 100 km in length. The MT9081x/x1 been designed for accurate far-end measurement of SM fiber metro networks up to 170 km in length.

Any of the A to G models can be selected according to the wavelength combination (1 to 3 wavelengths).

## ● Compact and lightweight (2.2 kg)

A field instrument must be completely portable in every location, whether at the top of a pole or down a manhole. The small, lightweight ACCESS Master leaves the engineer free to focus on the measurement and troubleshooting wherever he is. And since its rugged construction does not rely on a delicate hard disk, vibration and severe field conditions are never a problem.

## ● Fast start of less than 15 seconds

Power-on to Top Menu display takes just 15 seconds, permitting the engineer to get down to work almost immediately.

## ● Telcordia format (SR-4731) support

The commonly used Telcordia format (SR-4731) is supported.

## ● Stores more than 1,000 waveforms in internal memory and more than 30,000 waveforms in external USB flash memory\*1

Up to 1,000 waveforms can be stored in the ACCESS Master's internal memory and insertion of an external USB flash memory into the USB port provides storage for up to 30,000 more waveforms.\*1

\*1: Using 512-MB USB flash memory

## ● Waveform comparison

Using this function, measured data can be compared against data at fiber installation to spot aging changes and help predict faults before they occur.

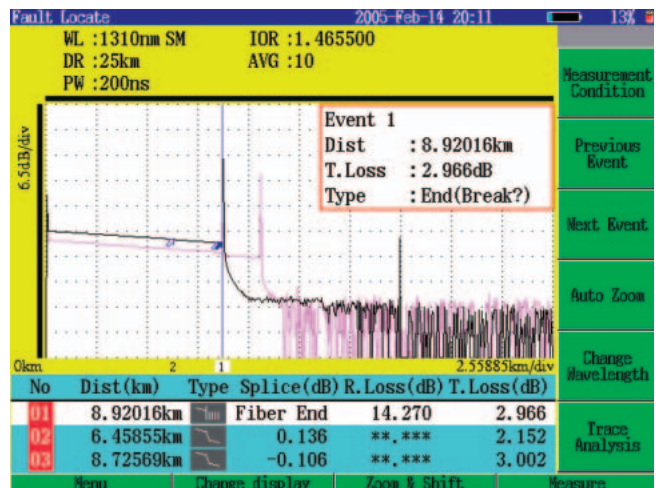
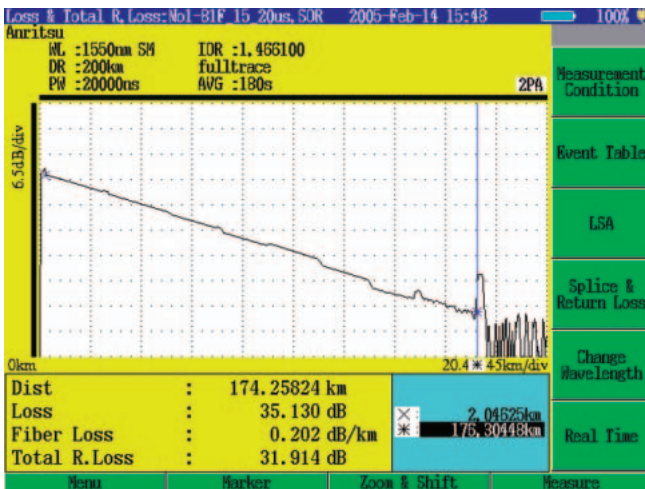



● **Active fiber check**

If the fiber under test is in service, the OTDR cannot perform accurate measurement and the light pulse from the OTDR may damage optical elements in the system. The ACCESS Master checks the fiber for in-service optical pulses and displays the check results on-screen.

● **Warning level setting**

Loss and events exceeding a preset value are highlighted in the event table for at-a-glance identification during installation and maintenance.

● **Printer, File Output Functions**

Screen images such as OTDR and IP network connection tests (option) can be printed to the connected BL-80R2 printer option (sold separately).

In addition, the files can be saved in PNG, JPEG and BMP formats (only firmware versions 2.02 or newer).

● **Two USB ports are provided as standard**

When the ACCESS Master is connected to a personal computer (PC) with a USB cable, the internal memory of the ACCESS Master can be accessed directly.

Connecting the ACCESS Master and PC directly permits data in the internal memory to be dragged and dropped directly into the PC memory, greatly simplifying operations like data copying.

Moreover, the ACCESS Master also supports use of USB memory sticks.

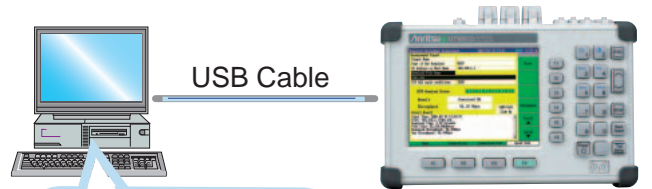

Internal memory can be accessed directly.

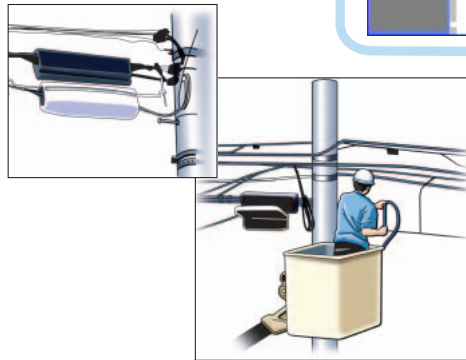
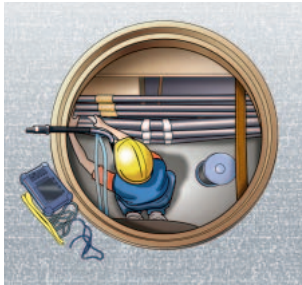

## GE-PON Service Support

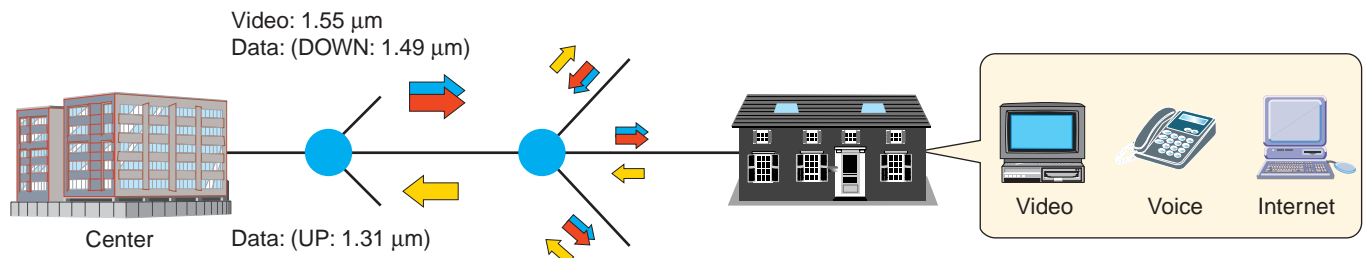

Triple Play (VoIP, TV, and Internet) services are quickly becoming the mainstream of FTTP. The GE-PON for implementing these increasingly popular optical services uses an optical-access wavelength of 1.31  $\mu\text{m}$  as well as 1.49  $\mu\text{m}$  for the down communications. In addition, video streaming uses a signal wavelength of 1.55  $\mu\text{m}$ . Consequently, maintaining optimum Triple Play services using GE-PON requires evaluation of three wavelength transmissions (1.31/1.49/1.55  $\mu\text{m}$ ).

Anritsu's MT9081G/G1 ACCESS Master supports all three wavelengths for evaluating GE-PON systems.

# IP Network Connection Check Function / Gigabit Ethernet Upgrade

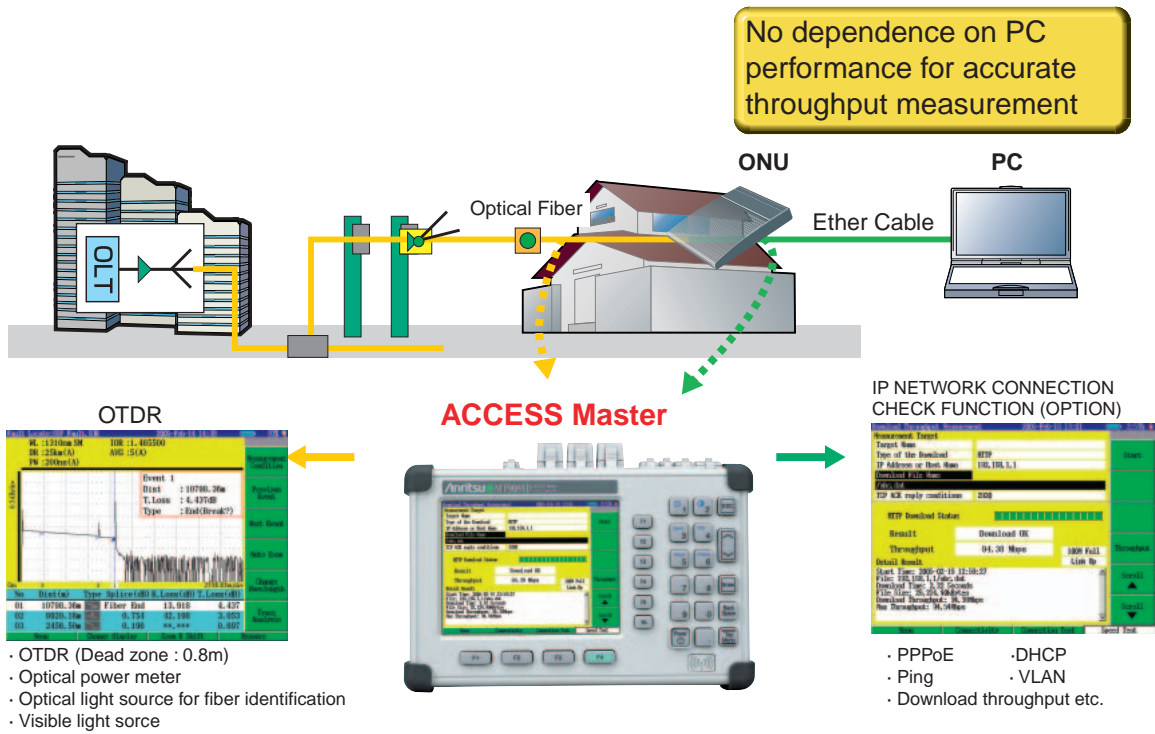

## ● One unit for detecting optical fiber fault and checking network connections

The MT9080 Series ACCESS Master has an optional built-in IP network connection check function that can be used to check the IP connection, a function that previously required a PC and IP tester.

Just one MT9080 Series ACCESS Master is all that is needed to perform quick and comprehensive fiber maintenance and troubleshooting, greatly cutting job time.

## ● Download Throughput Measurement at Full Wire Rate

Download throughput is a simple index of optical access service performance.

However, previous measurement results using a PC were seriously impacted by the performance of the PC itself (CPU speed, available RAM, OS, load status), making it difficult to obtain an accurate result.

The optional IP network connection check function provides a built-in measurement of 10Base-T/100Base-TX full-wire-rate download throughput. In concrete terms, an HTTP file is downloaded from a specified download site and the download speed at that time is measured and displayed. As a result, accurate measurement can be made with no effect from PC performance.

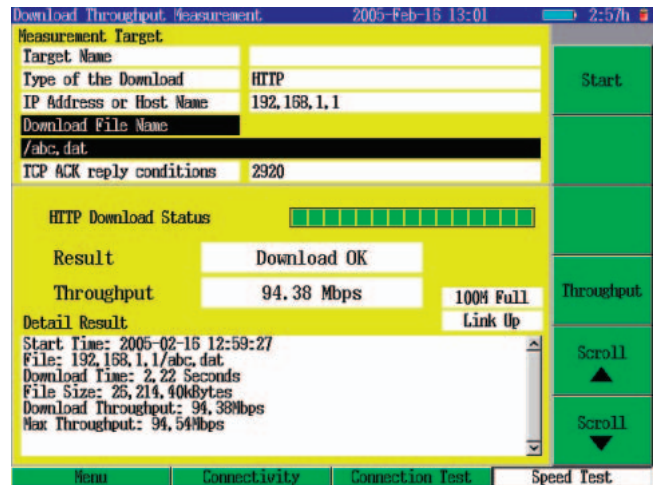

## ● Supports 1000Base-T Interface

Measurements of Gigabit Ethernet download speeds are approaching the limits of PC performance, making it very difficult to obtain accurate results. However, since the MT9080 Series Access Master has optional support for 1000Base-T interfaces, it can be used to evaluate the full-wire-rate download throughput even for 1000Base-T interfaces, making it unnecessary to use the latest high-speed PCs as Gigabit services become more widespread in the future.



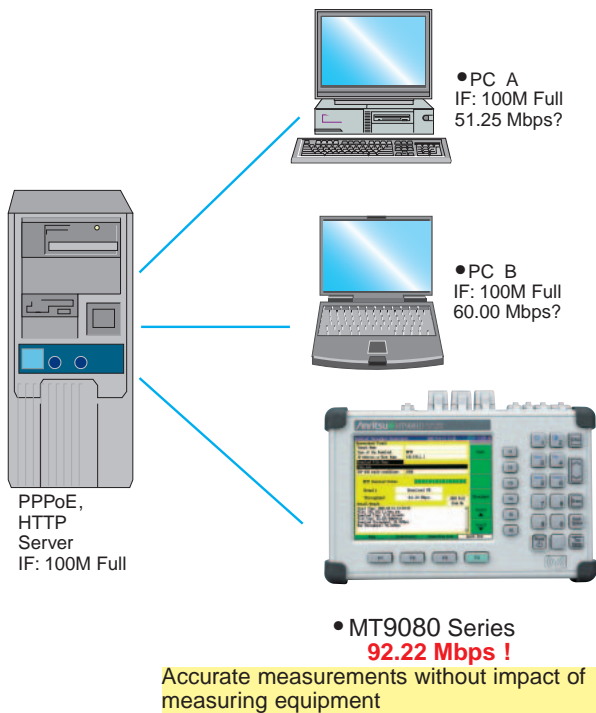

### ● Built-in Basic Test Functions

Each of the connection check, ping and traceroute, download throughput, and throughput functions both displays results as OK/NG and also provides result details.

If a test returns a NG result, the built-in basic test functions can be used to pinpoint and troubleshoot the problem as quickly as possible.

To analyze hard-to-resolve connection-type problems, it is also possible to save protocol dump files on-site for later laboratory analysis by networking specialists.

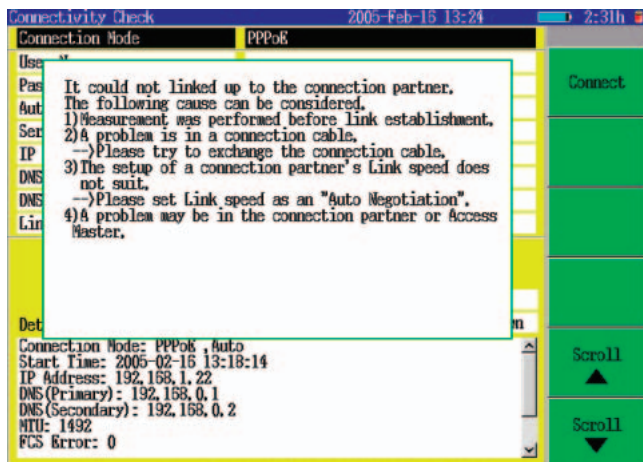

### ● Counter Measurement

Of course, it is also possible to effectively and visually monitor target frame receive rates, as well as packet and error counts to ensure that the network bandwidth is being used efficiently.

### ● Built-in Auto MDI/MDI-X Functions

Built-in straight/cross cable auto-sensing eliminates worries about cabling types when running in-exchange tests and lightens the cabling preparation workload when performing evaluations.

### ● Simple Measurement Procedures

The MT9080 Series Access Master makes the work of IP network connection checks simple. The operator runs the connection tests (ping and traceroute test, download throughput measurement, throughput measurement) and counter measurement procedures simply by selecting measurement items displayed at the function keys.

In addition, set measurement conditions can be saved in a file so that the next measurement can be performed easily and under the exact same conditions just by reading the saved file.

## MX907600A Emulation software

When this emulation software is installed on a Windows PC, field data from the ACCESS Master can be subjected to detailed analysis and report creation back at the bench.

### ● Emulation function

Waveform data can be analyzed on a Windows PC.

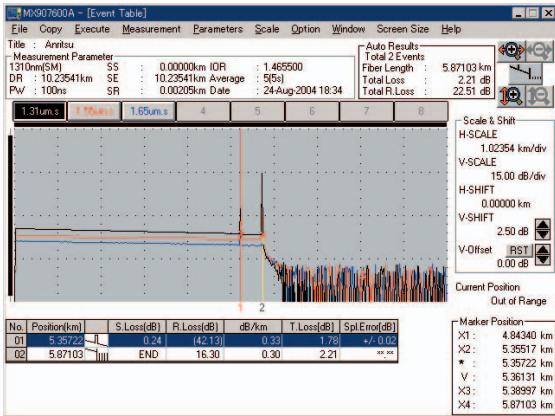

### ● Both-end measurement

A new waveform can be composed by averaging data measured at both ends of a fiber.

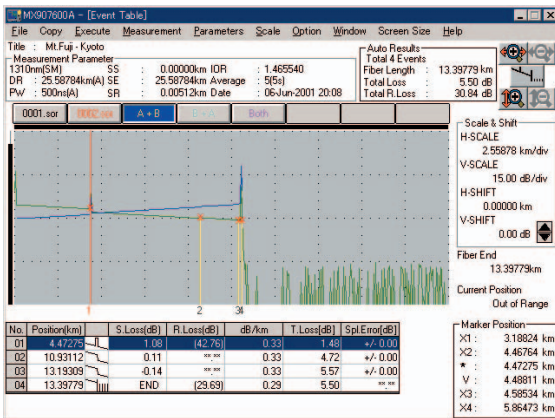

### ● Waveform difference display

This function is used to display the difference between two waveforms in another window, permitting easy detection of aging changes.

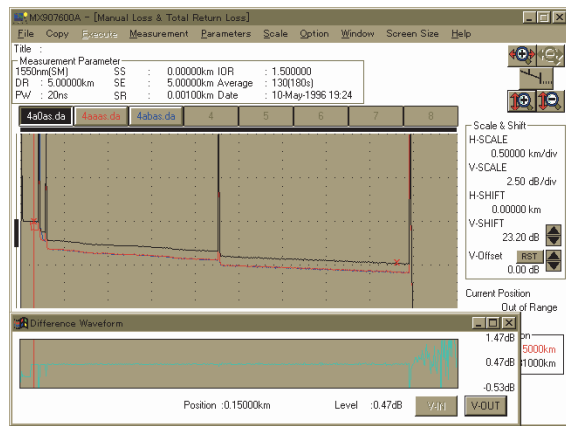

### ● Reporting

An event table can be analyzed and printed automatically and multiple waveforms can be printed on one page. At both-ends measurement, the measurement results for both ends can be output automatically to a report in the MS Excel file format.

Microsoft Excel - KF\_report.xls

Both Ends Measurement Splice Loss Summary Rep

Worksheets: 1310 nm

Splice Loss / Mt.Fuj - Kyoto City

Fiber No.	01	02	03	AVG	Min	Max	A=B (dB)
001	0.76	0.13	0.02	0.30	0.02	0.76	3.36
002	0.76	0.13	0.03	0.31	0.02	0.76	3.36
003	0.76	0.13	0.03	0.31	0.02	0.76	3.36
004	0.76	0.13	0.02	0.30	0.02	0.76	3.42
005	0.76	0.13	0.02	0.30	0.02	0.76	3.48
006	0.76	0.13	0.02	0.30	0.02	0.76	3.48
007	0.76	0.13	0.01	0.30	0.01	0.76	3.42
008	0.76	0.13	0.01	0.30	0.01	0.76	3.42

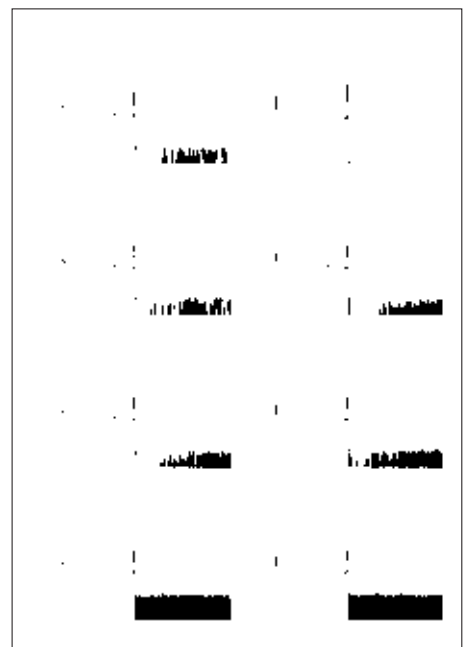



**MT9081[] ACCESS Master (main frame)**

Model	MT9081A/A1	MT9081B/B1	MT9081C/C1	MT9081D/D1	MT9081E/E1	MT9081F/F1	MT9081G/G1
Wavelength	1310 ±30 nm*1	1550 ±30 nm*1	1645 to 1655 nm*1,*2	1310/1550 ±30 nm*1	1550 ±30 nm/1645 to 1655 nm*1,*2	1310/1550 ±30 nm/1645 to 1655 nm*1,*2	1310/1490/1550 ±30 nm*1
Measurable optical fiber	10/125 μm single-mode optical fiber (ITU-T G.652)						
Optical connector	FC, SC, DIN, HMS-10/A, ST, LC (replaceable, PC type) FC, SC (APC type)						
Distance range	0.5, 1, 2.5, 5, 10, 25, 50, 100, 200 km						
Pulse width	3 ns, 10 ns, 20 ns, 50 ns, 100 ns, 200 ns, 500 ns, 1 μs, 2 μs, 4 μs, 10 μs, 20 μs						
Dynamic range*3,*4,*5 (S/N = 1)	38.5 dB (1.31 μm)	37 dB (1.55 μm)	33.5 dB (1.65 μm)	38 dB (1.31 μm) 36.5 dB (1.55 μm)	36 dB (1.55 μm) 33.5 dB (1.65 μm)	37.5 dB (1.31 μm) 36 dB (1.55 μm) 33.5 dB (1.65 μm)	36 dB (1.31 μm) 34.5 dB (1.49 μm) 34.5 dB (1.55 μm)
Dead zone*6 (back-scattered light) (IOR = 1.500000)	≤7.0 m (1.31 μm)	≤8.0 m (1.55 μm)	≤11 m (1.65 μm)	≤7.0 m (1.31 μm) ≤8.0 m (1.55 μm)	≤8.0 m (1.55 μm) ≤11 m (1.65 μm)	≤7.0 m (1.31 μm) ≤8.0 m (1.55 μm) ≤11 m (1.65 μm)	≤8.0 m (1.31 μm) ≤9.0 m (1.49 μm) ≤9.0 m (1.55 μm)
Dead zone*7 (back-scattered light) (IOR = 1.500000)	≤5.0 m (1.31 μm)	≤5.5 m (1.55 μm)	≤6.5 m (1.65 μm)	≤5.0 m (1.31 μm) ≤5.5 m (1.55 μm)	≤5.5 m (1.55 μm) ≤6.5 m (1.65 μm)	≤5.0 m (1.31 μm) ≤5.5 m (1.55 μm) ≤6.5 m (1.65 μm)	≤6.0 m (1.31 μm) ≤6.5 m (1.49 μm) ≤6.5 m (1.55 μm)
Dead zone*8 (Fresnel reflection) (IOR = 1.500000)	≤1 m ≤0.8 m (Typ.)						
Marker resolution (IOR = 1.500000)	0.05 to 400 m						
Sampling resolution (IOR = 1.500000)	0.05 to 40 m						
Sampling points	Normal: 5001 High density: 20001 or 25001*9						
Y-axis scale	0.05, 0.125, 0.25, 0.5, 1.25, 2.5, 5, 6.5 dB/div						
IOR settings	1.000000 to 1.999999 (0.000001 steps)						
Distance measurement accuracy	±1 m ±3 × measurement distance × 10 <sup>-5</sup> ±marker resolution (excluding uncertainty caused by fiber IOR)						
Loss measurement accuracy (linearity)	±0.05 dB/dB or ±0.1 dB (whichever is greater)						
Return loss measurement accuracy	±2 dB						
Automatic measurement*10	<p>Fault locate: Events judged as a failure are displayed sequentially from the first possible event. The distance of the possible event point, Total loss or Splice loss, and event type are displayed at the upper right of the wavelength display screen.</p> <p>Measurement items: Total loss, Total return loss or Average loss Each event distance, Connection loss, Return loss or Reflection amount, Total return loss or Average loss (displays in table format)</p> <p>Threshold values Connection loss: 0.01 to 9.99 dB (0.01 dB steps), Return loss: 20.0 to 60.0 dB (0.1 dB steps), Fiber-end: 1 to 99 dB (1 dB steps)</p> <p>Number of detected events: Up to 99</p> <p>Automatic setting: Distance range, Pulse width, Averaging count (time)</p> <p>Connection check: Automatic check of front panel connector connection quality</p> <p>Communication light check: Check for presence of communication light in optical fiber to be measured (≥-40 dBm)</p>						
Manual measurement	<p>Measurement items: Transmission loss and distance between 2 points, Loss per unit length between 2 points, Connection loss, Return loss or difference of levels</p> <p>Real-time sweep: 0.2 second or less (sampling mode: Normal)</p>						
Light source for identification tester	<p>Applicable fiber: SM fiber (ITU-T G.652), PC type</p> <p>Optical connector: Shared with OTDR (same port)</p> <p>Light emission element: FP-LD</p> <p>Central wavelength*11: 1310 ±30 nm (MT9081A/A1/D/D1/F/F1/G/G1) 1550 ±30 nm (MT9081B/B1/D/D1/E/E1/F/F1/G/G1) 1490 ±30 nm (MT9081G/G1) 1650 ±5 nm (MT9081C/C1/E/E1/F/F1)</p> <p>Optical output power*12: -5 dBm or more (MT9081A/A1/B/B1/C/C1/D/D1/E/E1/F/F1), -8 dBm or more (MT9081G/G1)</p> <p>Optical output waveform: CW/270 Hz/1 KHz/2 KHz (Modulation light is square wave)</p> <p>Modulated frequency: 270 Hz/1 KHz/2 KHz ±1.5%</p> <p>Warm-up time: 10 minutes (after turning optical output On)</p> <p>Laser safety specification: 21CFR Class 1, IEC 60825-1 Class 1</p>						

Model	MT9081A/A1	MT9081B/B1	MT9081C/C1	MT9081D/D1	MT9081E/E1	MT9081F/F1	MT9081G/G1
Optical power meter	Applicable fiber: SM fiber (ITU-T G.652) Wavelength setting: MT9081A/A1/B1/D/D1 (1310/1550 nm port): 1310/1550/1625/1650 nm MT9081C/C1/E/E1/F/F1 (1310/1550 nm port): 1310/1550/1625 nm (Wavelength range 1650 to 1625 nm) MT9081C/E/F (1650 nm port): 1650 nm (Wavelength range 1650 ±5 nm) Optical connector: Shared with OTDR Optical power: -50 to -5 dBm (peak power) (MT9081A/A1/B1/C/C1/D/D1/E/E1/F/F1), -47 to -2 dBm (peak power) (MT9081G/G1), Wavelength: 1550 nm, Absolute maximum rated input: +10 dBm Measurement accuracy: ±6.5% (-20 dBm, CW light, 23°C ±2°C, after executing zero offset, Wavelength 1550 nm)						
Other functions	Waveform storage: SR-4731, Horizontal offset setting (zero cursor setting), Internal memory Language display: Switchable by system configuration Power-saving setting function Backlight off: Disable/1 to 99 min., Shutdown: Disable/1 to 99 min. Power-saving in OTDR: High/Low/None Waveform comparing function, Calendar clock, Distance unit set: km, kf, mi, f, m Title input: Up to 32 characters Remaining battery power display, Auto dummy fiber setting function, Continuous light emitting function, Buzzer setting						
Display	6.4 inch color, TFT-LCD (MT9081x, 640 × 480 dots, with backlight, transparent type) 6.2 inch monochrome LCD (MT9081x1, 640 × 480 dots, with backlight, semi-transparent)						
Interface	USB 1.1 Type A × 1 (memory), Type B × 1 (USB mass storage class): The internal memory of the MT9080 Series product can be read/written as a PC disk drive by connecting with the PC via a USB cable.)						
Laser safety specification	21CFR Class 1, IEC 60825-1 Class 1						
Power supply	12 Vdc, Allowable input voltage range: 10.8 to 15 Vdc 100 to 240 Vac, Allowable input voltage range: 90 to 264 V, 50/60 Hz (Specific AC adapter is used.) Battery pack: DR15SBA can be used.						
Power	≤20 W (when charged), Standard 5 W (With backlight Off, sweeping halted)						
Battery operating time	Continuous operation time: 6.5 h <sup>*13</sup> (typical value, monochrome LCD), 5.0h <sup>*14</sup> (typical value, color-LCD)						
Battery charging time <sup>*15</sup>	≤3 h						
Dimensions and mass	254 (W) × 162 (H) × 61 (D) mm (main body only), ≤2 kg (only main frame), ≤2.2 kg (DR15SBA battery pack included) 277 (W) × 199 (H) × 80 (D) mm [main body + protector + protective cover (without hand strap and shoulder strap)], ≤2.9 kg [main body + battery pack + VLD + protector (without protective cover)]						
Environmental condition	Operating temperature and humidity: 0 to +40°C, ≤85% (no condensation), During battery charge: 0 to +30°C (power OFF), Storage temperature and humidity: -20 to +60°C, ≤85% Vibration: Conforming to MIL-T-28800E Class 3, Pulse shock: MIL-T-28800E, Move shock: MIL-T-28800E Style C (20.3 cm corner, surface total 14 times shocks, Power OFF), Vamp: IEC 63-2-29, JIS C 0042						
EMC	EN61326: 1997/A2: 2001 (Class A), EN61000-3-2: 2000 (Class A), EN61326: 1997/A2: 2001 (Annex A)						
LVD	EN61010-1: 2001 (Pollution Degree 2)						

\*1 At 25°C, pulse width: 1 μs

\*2 Wavelength range for 20 dB lower than the peak value. Peak value +15 dB or less.

\*3 At 25°C, pulse width: 20 μs, Distance range: 100 km, Average: 180 sec.

\*4 Dynamic range (one-way back-scattered light), SNR = 1: The level difference between the RMS noise level and the level where near end back-scattering occurs.

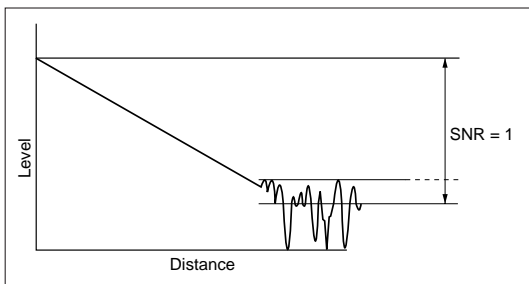

\*5 At 1.65 μm: With backlight, 1.31/1.55 μm -19 dBm CW light

\*6 At 25°C, pulse width: 10 ns, Return loss: 40 dB, Deviation: ±0.5 dB (Refer to the figure below.)

\*7 At 25°C, pulse width: 10 ns, Return loss: 55 dB, Deviation: ±0.5 dB (Refer to the figure below.)

\*8 At 25°C, pulse width: 3 ns (Refer to the figure below.)

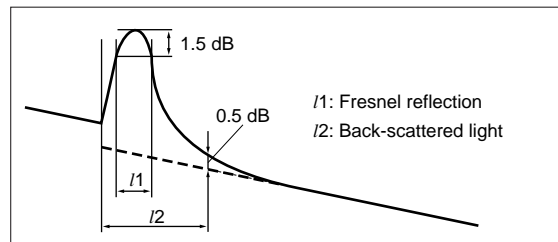

\*9 Either value is automatically selected in each mode, depending on the distance range.

\*10 The automatic measurement is an auxiliary function to facilitate measurement operations, and does not assure any detected results. As there may be a case of miss detection, be sure to check waveform data as well for final judgement of measured results.

\*11 25°C, CW

\*12 25°C, SM fiber 2 m, Modulation light: 270 Hz, Averaged power with 50% duty. Operating temperature range for 1.65 μm: 0 to +35°C

\*13 Backlight Off, Sweeping halted, at 25°C, monochrome LCD

\*14 Backlight Low, Sweeping halted, at 25°C, monochrome LCD

\*15 With power Off, Temperature range: 0 to +30°C



**MT9080[] ACCESS Master (main frame)**

Model	MT9080A	MT9080B	MT9080C	MT9080D	MT9080E	MT9080F
Wavelength	1310 ±30 nm*1	1550 ±30 nm*1	1645 to 1655 nm*1,*2	1310/1550 ±30 nm*1	1550 ±30 nm/ 1645 to 1655 nm*1,*2	1310/1550 ±30 nm/ 1645 to 1655 nm*1,*2
Measurable optical fiber	10/125 μm single-mode optical fiber (ITU-T G.652)					
Optical connector	FC, SC, DIN, HMS-10/A, ST, LC (replaceable, PC type) FC, SC (APC type)					
Distance range	0.5, 1, 2.5, 5, 10, 25, 50, 100 km					
Pulse width	3 ns, 20 ns, 50 ns, 100 ns, 200 ns, 500 ns, 1 μs, 2 μs					
Dynamic range*3,*4,*5 (S/N = 1)	26.5 dB (1.31 μm)	25 dB (1.55 μm)	22 dB (1.65 μm)	26 dB (1.31 μm) 24.5 dB (1.55 μm)	24.5 dB (1.55 μm) 22 dB (1.65 μm)	25.5 dB (1.31 μm) 24 dB (1.55 μm) 22 dB (1.65 μm)
Dead zone*6 (back-scattered light) (IOR = 1.500000)	≤7.5 m (1.31 μm)	≤8.5 m (1.55 μm)	≤11 m (1.65 μm)	≤7.5 m (1.31 μm) ≤8.5 m (1.55 μm)	≤8.5 m (1.55 μm) ≤11 m (1.65 μm)	≤7.5 m (1.31 μm) ≤8.5 m (1.55 μm) ≤11 m (1.65 μm)
Dead zone*7 (Fresnel reflection) (IOR = 1.500000)	≤1 m ≤0.8 m (Typ.)					
Marker resolution (IOR = 1.500000)	0.05 to 100 m					
Sampling resolution (IOR = 1.500000)	0.05 to 10 m					
Sampling points	Normal: 5001 High density: 20001 or 25001*8					
Y-axis scale	0.05, 0.125, 0.25, 0.5, 1.25, 2.5, 5, 6.5 dB/div					
IOR settings	1.000000 to 1.999999 (0.000001 steps)					
Distance measurement accuracy	±1 m ±3 × measurement distance × 10 <sup>-5</sup> ±marker resolution (excluding uncertainty caused by fiber IOR)					
Loss measurement accuracy (linearity)	±0.05 dB/dB or ±0.1 dB (whichever is greater)					
Return loss measurement accuracy	±2 dB					
Automatic measurement*9	<p>Fault locate: Events judged as a failure are displayed sequentially from the first possible event. The distance of the possible event point, Total loss or Splice loss, and event type are displayed at the upper right of the wavelength display screen.</p> <p>Measurement items: Total loss, Total return loss or Average loss Each event distance, Connection loss, Return loss or Reflection amount, Total return loss or Average loss (displays in table format)</p> <p>Threshold values Connection loss: 0.01 to 9.99 dB (0.01 dB steps), Return loss: 20.0 to 60.0 dB (0.1 dB steps), Fiber-end: 1 to 99 dB (1 dB steps)</p> <p>Number of detected events: Up to 99</p> <p>Automatic setting: Distance range, Pulse width, Averaging count (time)</p> <p>Connection check: Automatic check of front panel connector connection quality</p> <p>Communication light check: Check for presence of communication light in optical fiber to be measured (≥-40 dBm)</p>					
Manual measurement	<p>Measurement items: Transmission loss and distance between 2 points, Loss per unit length between 2 points, Connection loss, Return loss or difference of levels</p> <p>Real-time sweep: 0.2 second or less (sampling mode: Normal)</p>					
Light source for identification tester	<p>Applicable fiber: SM fiber (ITU-T G.652), PC type</p> <p>Optical connector: Shared with OTDR (same port)</p> <p>Light emission element: FP-LD</p> <p>Central wavelength*10: 1310 ±30 nm (MT9080A/D/F) 1550 ±30 nm (MT9080B/D/E/F) 1650 ±5 nm (MT9080C/E/F)</p> <p>Optical output power*11: -8 dBm or more</p> <p>Optical output waveform: 270 Hz/1 KHz/2 KHz (Modulation light is square wave)</p> <p>Modulated frequency: 270 Hz/1 KHz/2 KHz ±1.5%</p> <p>Warm-up time: 10 minutes (after turning optical output On)</p> <p>Laser safety specification: 21CFR Class 1, IEC 60825-1 Class 1</p>					
Optical power meter	<p>Applicable fiber: SM fiber (ITU-T G.652)</p> <p>Wavelength setting: MT9080A/B/D (1310/1550 nm port): 1310/1550/1625/1650 nm MT9080C/E/F (1310/1550 nm port): 1310/1550/1625 nm MT9080C/E/F (1650 nm port): 1650 nm</p> <p>Optical connector: Shared with OTDR</p> <p>Optical power: -50 to -5 dBm (peak power)</p> <p>Absolute maximum rated input: +10 dBm</p> <p>Measurement accuracy: ±6.5% (-20 dBm, CW light, 23°C ±2°C, after executing zero offset, Wavelength 1550 nm)</p>					

Model	MT9080A	MT9080B	MT9080C	MT9080D	MT9080E	MT9080F
Other functions	Waveform storage: SR-4731, Horizontal offset setting (zero cursor setting), Internal memory Language display: Switchable by system configuration Power-saving setting function Backlight off: Disable/1 to 99 min., Shutdown: Disable/1 to 99 min. Power-saving in OTDR: High/Low/None Waveform comparing function, Calendar clock, Distance unit set: km, kf, mi, f, m Title input: Up to 32 characters Remaining battery power display, Auto dummy fiber setting function, Continuous light emitting function, Buzzer setting					
Display	6.2 inch monochrome LCD (Option 04, 640 × 480 dots, with backlight, semi-transparent)					
Interface	USB 1.1 Type A × 1 (memory), Type B × 1 (USB mass storage class): The internal memory of the MT9080 Series product can be read/written as a PC disk drive by connecting with the PC via a USB cable.)					
Laser safety specification	21CFR Class 1, IEC 60825-1 Class 1					
Power supply	12 Vdc, Allowable input voltage range: 10.8 to 15 Vdc 100 to 240 Vac, Allowable input voltage range: 90 to 264 V, 50/60 Hz (Specific AC adapter is used.) Battery pack: DR15SBA can be used.					
Power	≤20 W (when charged), Standard 5 W (With backlight Off, sweeping halted)					
Battery operating time*12	Continuous operation time: 6.5 h (typical value)					
Battery charging time*13	≤3 h					
Dimensions and mass	254 (W) × 162 (H) × 61 (D) mm (main body only), ≤2 kg (only main frame), ≤2.2 kg (DR15SBA battery pack included) 277 (W) × 199 (H) × 80 (D) mm [main body + protector + protective cover (without hand strap and shoulder strap)], ≤2.9 kg [main body + battery pack + VLD + protector (without protective cover)]					
Environmental condition	Operating temperature and humidity: 0 to +40°C, ≤85% (no condensation), During battery charge: 0 to +30°C (power OFF), Storage temperature and humidity: -20 to +60°C, ≤85% Vibration: Conforming to MIL-T-28800E Class 3, Pulse shock: MIL-T-28800E, Move shock: MIL-T-28800E Style C (20.3 cm corner, surface total 14 times shocks, Power OFF), Vamp: IEC 63-2-29, JIS C 0042					
EMC	EN61326: 1997/A2: 2001 (Class A), EN61000-3-2: 2000 (Class A), EN61326: 1997/A2: 2001 (Annex A)					
LVD	EN61010-1: 2001 (Pollution Degree 2)					

\*1 At 25°C, pulse width: 1 μs

\*2 Wavelength range for 20 dB lower than the peak value. Peak value +15 dB or less.

\*3 At 25°C, pulse width: 2 μs, Distance range: 50 km, Average: 180 sec.

\*4 Dynamic range (one-way back-scattered light), SNR = 1: The level difference between the RMS noise level and the level where near end back-scattering occurs.

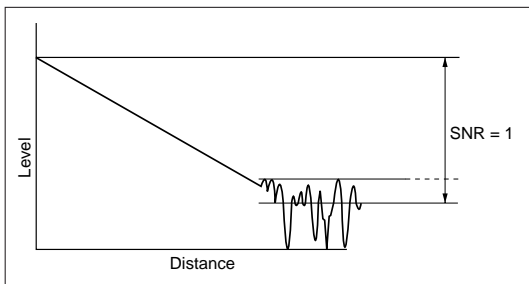

\*5 At 1.65 μm: With backlight, 1.31/1.55 μm -19 dBm CW light

\*6 At 25°C, pulse width: 20 ns, Return loss: 40 dB, Deviation: ±0.5 dB (Refer to the figure below.)

\*7 At 25°C, pulse width: 3 ns (Refer to the figure below.)

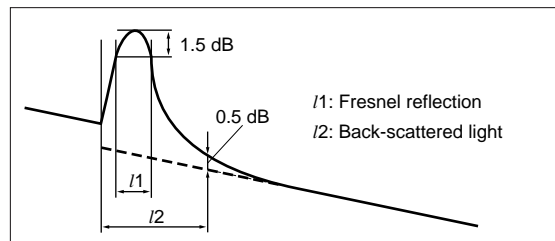

\*8 Either value is automatically selected in each mode, depending on the distance range.

\*9 The automatic measurement is an auxiliary function to facilitate measurement operations, and does not assure any detected results. As there may be a case of miss detection, be sure to check waveform data as well for final judgement of measured results.

\*10 25°C, 270 Hz

\*11 25°C, SM fiber 2 m, Modulation light: 270 Hz, Averaged power with 50% duty. Operating temperature range for 1.65 μm: 0 to +35°C

\*12 Backlight Off, Sweeping halted, at 25°C

\*13 With power Off, Temperature range: 0 to +30°C



● **Battery pack: DR15SBA**

Battery	Ni-MH secondary battery
Voltage, capacity	10.8 Vdc, 2100 mAh
Dimensions and mass	145 (W) × 52.8 (H) × 19.3 (D) mm, 305 g typ.
Operating temperature	Charging: 0 to +45°C Discharging: -20 to +50°C Storage: -20 to +35°C

● **AC adapter: SA165A-1250V-3**

Rated AC input	100 to 240 Vac, 50/60 Hz
Rated DC output	12 Vdc, 3 A
Dimensions and mass	122 (W) × 60 (H) × 34 (D) mm, 305 ±5 g
Environmental conditions	Operating temperature: 0 to +40°C, 20 to 80% R.H. Storage temperature: -20 to +80°C 10 to 95% R.H.

● **Visible LD (Option 002/02)**

Central wavelength	650 nm ±15 nm (at 25°C)
Optical output	-3 ±1.5 dBm
Output optical fiber	10/125 μm, SM (ITU-T G.652)
Optical connector	FC, SC, ST, DIN, HMS-10/A, LC
Optical safety	IEC60825-1 Class 1M, 21CFR Class 2
Environmental conditions	Operating temperature and humidity: 0 to +40°C, ≤85% (no condensation)

**Safety measures for laser products**

This option complies with optical safety standards in Class 1M of the IEC 60825-1 and the FDA (21CFR1040.10, USA) in Class 2; the following descriptive labels are affixed to the product (FDA label is only affixed to product for export to the USA).

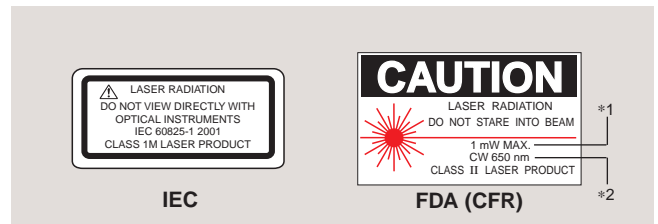

The maximum output is indicated under \*1, and the wavelength under \*2.  
Caution: Do not look directly into the laser beam.

● **IP network connection check function (Option 001) / Gigabit Ethernet Upgrade (Option 011)**

Model	MT9081[]-001 / MT9080[]-001	MT9081[]-011 / MT9080[]-011
Name	IP Network Connection Check Function	
Measurement IF	10BASE-T/100BASE-TX : 1 port	
IF Speed Others	10M/100M Full, 10M/100M Half, Auto negotiation Auto MDI/MDI-X	
Connectivity Check Connection mode VLAN VID COS Check	PPPoE, DHCP, Manual VLAN setup is possible in the DHCP Mode and Manual Mode. Single VLAN tag is supported. 1 to 4094 0 to 7 OK/NG Judgment	
Connection Test Ping Test Number of times Timeout Threshold Trace Route Test Timeout Threshold Hops	Can be executed after the connection is established by using the Connectivity Check function. 1 to 999 1 to 60 s 2 to 60 s 1 to 255	
Download throughput measurement Download file size Download throughput value	Can be performed after the connection is established by using the Connectivity Check function. The full wire rate is supported. Up to 1 GB Download file size [bits] / Download time [s]	
Throughput measurement Frame size Transmit Rate Transmit Duration Time Resolution Loss Tolerance	Can be performed after the connection is established by using the Connectivity Check function. 64, 128, 256, 512, 768, 1024, 1280, 1518, 9018, 9618 : The frame size 9018 and 9618 can be selected when the link speed is 1000M. 1 to 100% of the line band (100% at full-wire rate), in steps of 1% 5, 10, 15, 20, 30, 60, 180, 300 s 1% or 5% of the line band 0, 0.01, 0.1, 1, 5, 10%	
Counter measurement Measurement time Frame type	1 to 720 min, in steps of 1 min. All frame, Only PPPoE frame, Only VLAN frame	
Environmental condition	Operating temperature and humidity: 0 to +40°C, ≤85% (no condensation) Storage temperature and humidity: -20 to +60°C, ≤85%	

# Ordering Information

Please specify model/order number, name and quantity when ordering.

## MT9081[ ]

Model/Order No.	Name
<b>— ACCESS Master (main frame) —</b>	
MT9081A/A1	SMF 1.31 μm
MT9081B/B1	SMF 1.55 μm
MT9081C/C1	SMF 1.65 μm
MT9081D/D1	SMF 1.31/1.55 μm
MT9081E/E1	SMF 1.55/1.65 μm
MT9081F/F1	SMF 1.31/1.55/1.65 μm
MT9081G/G1	SMF 1.31/1.49/1.55 μm
<b>— Standard accessories —</b>	
W2487AE	MT9080 Series operation manual (CD): 1 copy
SA165A-1250V-3	AC adapter: 1 pc
DR15SBA	Battery pack: 1 pc
<b>— Software —</b>	
MX907600A	OTDR Emulation Software
<b>— Options*1 —</b>	
MT9081[ ]-001	IP Network Connection Check Function
MT9081[ ]-011*2	Gigabit Ethernet Upgrade
MT9081[ ]-201*3	IP Network Connection Check Function (Retrofit)
MT9081[ ]-211*3	Gigabit Ethernet Upgrade (Retrofit)
MT9081[ ]-002	Visible LD (Factory option)
MT9081[ ]-009*4	English language display
MT9081[ ]-010*5	Protector
MT9081[ ]-210*5	Protector (Retrofit)
MT9081[ ]-018*6	Chinese
MT9081[ ]-020*6	Korean
MT9081[ ]-025*7	FC-APC connector (Factory option)
MT9081[ ]-026*7	SC-APC connector (Factory option)
MT9081[ ]-033*7	LC connector
MT9081[ ]-037*7	FC connector
MT9081[ ]-038*7	ST connector
MT9081[ ]-039*7	DIN connector
MT9081[ ]-040*7	SC connector
MT9081[ ]-043*7	HMS-10/A connector

- \*1 Installed in MT9081A/B/C/D/E/F/G/A1/B1/C1/D1/E1/F1/G1
- \*2 Added option for Option 001. Installation not supported for Option 001 only.
- \*3 May not be supported depending on main-unit serial number (product date)
- \*4 Please be sure to specify.
- \*5 Protective front cover and shoulder strap included
- \*6 When wanting to use either Chinese or Korean languages, please specify the correct language option number.
- \*7 Specify the optical connector

## MT9080[ ]

Model/Order No.	Name
<b>— ACCESS Master (main frame) —</b>	
MT9080A	SMF 1.31 μm
MT9080B	SMF 1.55 μm
MT9080C	SMF 1.65 μm
MT9080D	SMF 1.31/1.55 μm
MT9080E	SMF 1.55/1.65 μm
MT9080F	SMF 1.31/1.55/1.65 μm
<b>— Standard accessories —</b>	
W2487AE	MT9080 Series operation manual (CD): 1 copy
SA165A-1250V-3	AC adapter: 1 pc
DR15SBA	Battery pack: 1 pc
<b>— Software —</b>	
MX907600A	OTDR Emulation Software
<b>— Options*1 —</b>	
MT9080[ ]-001	IP Network Connection Check Function
MT9080[ ]-011*2	Gigabit Ethernet Upgrade
MT9080[ ]-201*3	IP Network Connection Check Function (Retrofit)
MT9080[ ]-211*3	Gigabit Ethernet Upgrade (Retrofit)
MT9080[ ]-02	Visible LD (Factory option)
MT9080[ ]-04*4	Monochrome LCD
MT9080[ ]-09*4	English language display
MT9080[ ]-10*5	Protector
MT9080[ ]-210*5	Protector (Retrofit)
MT9080[ ]-018*6	Chinese
MT9080[ ]-020*6	Korean
MT9080[ ]-25*7	FC-APC connector (Factory option)
MT9080[ ]-26*7	SC-APC connector (Factory option)
MT9080[ ]-33*7	LC connector
MT9080[ ]-37*7	FC connector
MT9080[ ]-38*7	ST connector
MT9080[ ]-39*7	DIN connector
MT9080[ ]-40*7	SC connector
MT9080[ ]-43*7	HMS-10/A connector

- \*1 Installed in MT9080A/B/C/D/E/F
- \*2 Added option for Option 001. Installation not supported for Option 001 only.
- \*3 May not be supported depending on main-unit serial number (product date)
- \*4 Please be sure to specify.
- \*5 Protective front cover and shoulder strap included
- \*6 When wanting to use either Chinese or Korean languages, please specify the correct language option number.
- \*7 Specify the optical connector



Soft carrying case (B0547)



Soft transit case (B0548)



Hard carrying case (B0549)

**Common to the MT9080 Series**

Please specify model/order number, name and quantity when ordering.

Model/Order No.	Name	Remarks
	<p align="center"><b>— Application parts —</b></p>	
W2462AE	MT9080 Series operation manual (print)	
W2546AE	IP network connection check function manual (print)	
B0547	Soft carrying case	It can't use, when it equips with a protector (option 010/10). Attache case type [440 (W) × 310 (H) × 110 (D) mm]
B0548	Soft transit case	
B0549	Hard carrying case	Only front cover for option 010/10
B0550	Front cover (For Option 010/10)	
DR15SBA	Battery pack	
Z0740	Battery charger (For DR15SBA)	
J1295	Car plug cord	
J1270	Replaceable optical LC connector	
J0617B	Replaceable optical FC connector	
J0618D	Replaceable optical ST connector	
J0618E	Replaceable optical DIN connector	
J0618F	Replaceable optical HMS-10/A connector	
J0619B	Replaceable optical SC connector	
J0057	Optical adapter FC type	
J0635( )	Optical fiber cord with FC-PC at both ends (SM, with FC-PC at both ends)	Specify the optical fiber length as A, B or C (A: 1 m, B: 2 m, C: 3 m)
Z0282	Ferrule cleaner	
Z0283	Ferrule cleaning tape (6 pcs/set)	
Z0284	Adapter cleaner (Stick type, 200 pcs/set)	
	<p align="center"><b>— Peripherals —</b></p>	
BL-80R2	High speed thermal printer	Operates only with AC adapter, printing width: 72 mm, printing speed: approximately 13 s (manual measurement result with header), 0 to +40°C, dimensions: 119 (W) × 77 (H) × 174 (D) mm, sanei products (AC adapter and printer cable are sold separately.) For BL-80R2, AC 100 to 240 V ACCESS Master connection cable
BL-100W	AC adapter	
J1314	Printer cable	
	<p align="center"><b>— Supplies —</b></p>	
BL-80-30	Printer paper	For BL-80R2 Thermal Printer (10 rolls/set)

**Package Ordering**

Model/Order No.	Name	Remarks
Z0821	MT9081D Basic kit	Refer to the following for the composition of each package.
Z0822	MT9081D VLD kit	
Z0823	MT9081D IP kit	
Z0824	Additional Battery kit	

Model	Name	Package Ordering			
		MT9081D Basic kit	MT9081D Visible LD kit	MT9081D IP kit	Additional Battery kit
MT9081D	Mainframe	√	√	√	
MT9081D-009	English key panel	√	√	√	
MT9081D-010	Protector	√	√	√	
MT9081D-002	Visible LD		√	√	
B0548	Soft transit case	√	√	√	
J1295	Car plug cord	√	√	√	
MT9081D-37	FC connector	√	√	√	
MT9081D-001	IP Connection Check Function			√	
MT9081D-011	Gigabit Ethernet Upgrade			√	
DR15SBA	Battery pack				√
Z0740	Battery charger				√



Thermal Printer (BL-80R2)





Battery charger (Z0740)  
Battery pack (DR15SBA)



Car plug cord (J1295)



# Selection Guide

Model	MT9081x	MT9081x1	MT9080x
			
<b>Specifications</b>			
Display	6.4 inch color TFT-LCD (with back light, transparent type)		6.2 inch monochrome LCD (with back light, semi-transparent)
Distance range	max. 200 km		max. 100 km
Pulse width	3 ns, 10 ns, 20 ns, 50 ns, 100 ns, 200 ns, 500 ns, 1 μs, 2 μs, 4 μs, 10 μs, 20 μs		3 ns, 20 ns, 50 ns, 100 ns, 200 ns, 500 ns, 1 μs, 2 μs
Dynamic range 1,31/1.55 μm (D type)	38 dB / 36.5 dB		26 dB / 24.5 dB
Dead zone (back-scattered light) 1,31/1.55 μm (D type)	≤ 7.0 m / ≤ 8.0 m (Return loss 40 dB) ≤ 5.0 m / ≤ 5.5 m (Return loss 55 dB)		≤ 7.5 m / ≤ 8.5 m (Return loss 40 dB)
Dead zone (Fresnel reflection) 1,31/1.55 μm (D type)	≤ 1 m (Typ. 0.8 m)		
<b>Options</b>			
IP Network Connection Check Function	√	√	√
Gigabit Ethernet Upgrade	√	√	√
Visible LD	√	√	√

# Anritsu

Specifications are subject to change without notice.

## ANRITSU CORPORATION

5-1-1 Onna, Atsugi-shi, Kanagawa, 243-8555 Japan  
Phone: +81-46-223-1111  
Fax: +81-46-296-1264

### • U.S.A.

#### ANRITSU COMPANY

#### TX OFFICE SALES AND SERVICE

1155 East Collins Blvd., Richardson, TX 75081, U.S.A.  
Toll Free: 1-800-ANRITSU (267-4878)  
Phone: +1-972-644-1777  
Fax: +1-972-644-3416

### • Canada

#### ANRITSU ELECTRONICS LTD.

700 Silver Seven Road, Suite 120, Kanata,  
ON K2V 1C3, Canada  
Phone: +1-613-591-2003  
Fax: +1-613-591-1006

### • Brasil

#### ANRITSU ELETRÔNICA LTDA.

Praca Amadeu Amaral, 27 - 1 andar  
01327-010 - Paraiso, Sao Paulo, Brazil  
Phone: +55-11-3283-2511  
Fax: +55-11-3886940

### • U.K.

#### ANRITSU LTD.

200 Capability Green, Luton, Bedfordshire LU1 3LU, U.K.  
Phone: +44-1582-433280  
Fax: +44-1582-731303

### • Germany

#### ANRITSU GmbH

Nemetschek Haus Konrad-Zuse-Platz 1 81829  
München, Germany  
Phone: +49 (0) 89 442308-0  
Fax: +49 (0) 89 442308-55

### • France

#### ANRITSU S.A.

9, Avenue du Québec Z.A. de Courtabœuf 91951 Les  
Ulis Cedex, France  
Phone: +33-1-60-92-15-50  
Fax: +33-1-64-46-10-65

### • Italy

#### ANRITSU S.p.A.

Via Elio Vittorini, 129, 00144 Roma EUR, Italy  
Phone: +39-06-509-9711  
Fax: +39-06-502-2425

### • Sweden

#### ANRITSU AB

Borgafjordsgatan 13 164 40 Kista, Sweden  
Phone: +46-853470700  
Fax: +46-853470730

### • Finland

#### ANRITSU AB

Teknobulevardi 3-5, FI-01530 Vantaa, Finland  
Phone: +358-9-4355-220  
Fax: +358-9-4355-2250

### • Denmark

#### Anritsu A/S

Kirkebjerg Allé 90 DK-2605 Brøndby, Denmark  
Phone: +45-72112200  
Fax: +45-72112210

### • Singapore

#### ANRITSU PTE LTD.

10, Hoe Chiang Road #07-01/02, Keppel Towers,  
Singapore 089315  
Phone: +65-6282-2400  
Fax: +65-6282-2533

### • Hong Kong

#### ANRITSU COMPANY LTD.

Suite 923, 9/F., Chinachem Golden Plaza, 77 Mody  
Road, Tsimshatsui East, Kowloon, Hong Kong, China  
Phone: +852-2301-4980  
Fax: +852-2301-3545

### • P. R. China

#### ANRITSU COMPANY LTD.

#### Beijing Representative Office

Room 1515, Beijing Fortune Building, No. 5 North Road,  
the East 3rd Ring Road, Chao-Yang District  
Beijing 100004, P.R. China  
Phone: +86-10-6590-9230

### • Korea

#### ANRITSU CORPORATION

8F Hyun Juk Bldg. 832-41, Yeoksam-dong,  
Kangnam-ku, Seoul, 135-080, Korea  
Phone: +82-2-553-6603  
Fax: +82-2-553-6604

### • Australia

#### ANRITSU PTY LTD.

Unit 3/170 Forster Road Mt. Waverley, Victoria, 3149,  
Australia  
Phone: +61-3-9558-8177  
Fax: +61-3-9558-8255

### • Taiwan

#### ANRITSU COMPANY INC.

7F, No. 316, Sec. 1, NeiHu Rd., Taipei, Taiwan  
Phone: +886-2-8751-1816  
Fax: +886-2-8751-1817

### • India

#### ANRITSU CORPORATION

#### India Liaison Office

Unit No. S-3, Second Floor, Esteem Red Cross Bhavan,  
No. 26, Race Course Road, Bangalore 560 001, India  
Phone: +91-80-30944707



Printed with environment-friendly  
vegetable soybean oil ink.



Printed on 100%  
Recycled Paper