

# Lightning™ 37000D Vector Network Analyzers

40 MHz to 65 GHz



Network Analysis Solutions for Design and Manufacturing

# Vector Network Analyzers that offer . . .

---

The 37000D Lightning™ Vector Network Analyzers are high performance test tools enhanced to better satisfy the growing needs of defense, satellite, radar, broadband communication, and high speed component markets. The new 37000D VNAs improve upon performance while providing a wider set of standard application features to better suit the needs of R&D engineers working on next generation designs. These new features, when combined with the ease of programming through helpful software utilities and faster data transfer over Ethernet, make it an equally valuable tool for manufacturing as well.

The 37000D series consists of two primary configurations built for the R&D and Production applications:

## Premium Models (37300D)

The Premium models are designed for active and passive device applications, where versatility is the main priority. These are high performance two-port VNAs that include step attenuators, internal bias tees, a gain compression application and wider power range as standard features.

They are available in four different frequency ranges, namely 20 GHz (37347D), 40 GHz (37369D), 50 GHz (37377D) and 65 GHz (37397D). Each model can also be configured as an ME7808B millimeter-wave VNA by simply adding a millimeter-wave test set, two synthesizers and the desired mmW modules. The 37397D VNA is also directly upgradeable to a ME7808B Broadband (40 MHz to 110 GHz) VNA.

## Economy Models (37200D)

The Economy models are basic two-port VNAs designed for passive applications. They are available in four different frequency ranges, namely 20 GHz (37247D), 40 GHz (37269D), 50 GHz (37277D) and 65 GHz (37297D). Each model can be configured as an economy millimeter-wave VNA by simply adding a millimeter-wave test set, two synthesizers and the desired mmW modules. They differ from the Premium series in their ALC range, power handling capability, and do not include internal bias tees or the gain compression application.

There is a suite of application features available as standard on both of the VNA series. The **Rear Panel IF Inputs** enable the upgrade to millimeter-wave. The **Multiple Source Control** mode permits measurement of frequency translated devices such as mixers, multipliers etc. The **E/O and O/E Measurement** capability when used with an available O/E calibration accessory enables characterization of both E/O (modulators) and O/E (photodiodes, receivers) components.

There are a variety of options available for both VNA series to further enhance measurement capability. The **Time Domain Option (Option 2)** allows characterization of impedance as a function of distance, helpful in locating discontinuities in components. The **Flexible Test Option (Option 15)** provides access to all four samplers for mixer measurements, and facilitates integration of external test sets such as Multiport. It also includes two auxiliary source loops for enhancing source power or applying an external source.

### Standard features on 37300D VNAs include:

- Multiple Source Control mode and Frequency Offset
- E/O and O/E measurements
- Gain Compression application
- Internal Bias tees
- Extended Power Range (Source Step Attenuator and test port attenuator)
- Rear Panel IF inputs
- NxN Calibration Utility for Mixer Measurements
- Embed/De-Embed Application
- High Stability Frequency Reference
- 1 Hz Frequency Resolution

### Standard features on 37200D VNAs include:

- Multiple Source Control mode and Frequency Offset
- E/O and O/E measurements
- Rear Panel IF inputs
- NxN Calibration Utility for Mixer Measurements
- Embed/De-Embed Application
- High Stability Frequency Reference
- 1 Hz Frequency Resolution

# ..... application versatility

## Frequency Translated Measurements

All Lightning D VNAs have the Multiple Source Control feature, which allows the user to set different frequencies for the source and the receiver. This feature when paired with the Flexible test set (Option 15), which provides direct access to the four samplers, enables measurements of conversion loss, port match, isolation, relative group delay, amplitude tracking and phase tracking for frequency translation devices such as mixers, upconverters, and downconverters.

In addition, the built-in NxN mixer calibration utility provides guided steps on performing a calibration for error-corrected measurements of magnitude, phase and group delay of mixers.

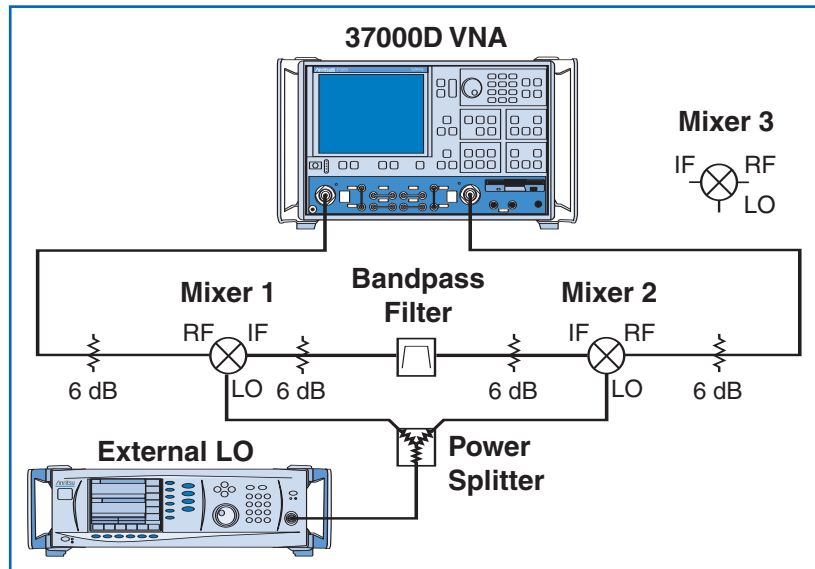

Mixer NxN setup



E/O measurement of an optical modulator

## E/O and O/E Measurements

The 37000D VNAs incorporate an E/O and O/E measurement application that simplifies VNA calibration when measuring E/O and O/E devices. This enables characterization of the transfer function, group delay, and return loss of optical modulators (E/O) and photoreceivers (O/E). An MN4765A O/E calibration module (65 GHz) and an Anritsu laser source are required to complete the test set-up. The internal VNA application de-embeds the response of the O/E calibration module, to allow direct measurement of the modulator. For O/E measurements, the O/E module is used to characterize a modulator which becomes the reference standard when making photoreceiver measurements.

# Vector Network Analyzers that offer . . .

## Gain Compression Measurements

The standard gain compression application in all Lightning D VNAs allows the user to thoroughly characterize the gain compression of amplifiers using swept frequency and swept power routines. By manually increasing the calibrated flat test port power, it is possible to measure the minimum gain compression point within a frequency range. For more traditional gain compression measurements at selected CW frequencies, the application menu guides through the linear port power calibration process. The built-in software will sweep the power and detect the selected compression point at up to ten CW frequencies. The results are then displayed in graphical and tabular format.

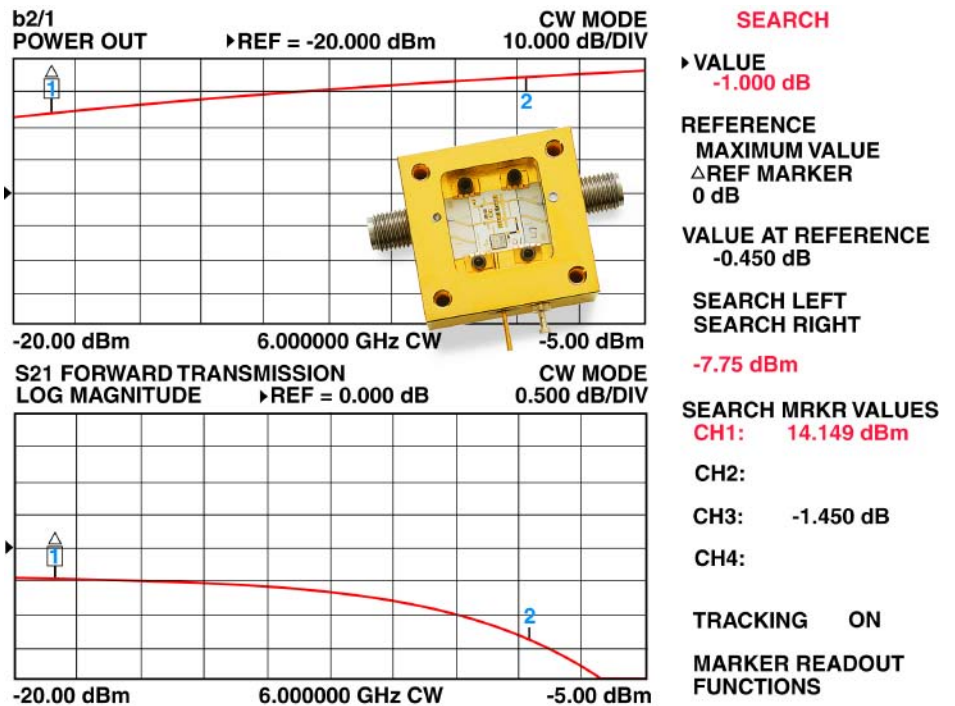

$P_{OUT}$  vs.  $P_{IN}$  and Compression plot of an amplifier

## Time Domain Analysis

The Time Domain feature (Option 2) helps analyze impedance discontinuities in connectors, circuits etc. as a function of either time or distance. The Windowing and Gating functions available in Time domain help isolate individual reflections in time and evaluate their effects in the frequency domain. This is extremely useful in the removal of the effects of device packages and fixturing to see the actual performance of the DUT.

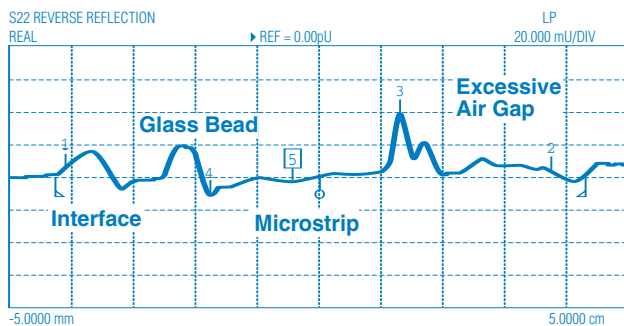

The 37000D VNA time domain feature provides four different windowing functions to optimize dynamic range and resolution. Also, the unique Phasor Impulse Mode helps measure the true impedance characteristics of mismatches in band-limited components such as waveguide and microstrip. The dielectric of the material used can be entered to calculate actual electrical distance of the DUT.



# ..... application versatility

## On-Wafer Measurements

37000D VNAs can be easily integrated with probe stations from leading probe manufacturers for making accurate on-wafer measurements in both microwave and millimeter-wave bands. Compatibility with popular calibration software such as SussCal® from Suss Microtec and Wincal® from Cascade Microtech enable fast automated calibrations for accurate measurements of discrete FETs, MMIC's, passive components, multiport devices etc.

The advanced measurement capabilities of the 37000D VNAs are further enhanced through compatibility with popular computer-aided design and test packages such as IC-CAP from Agilent EEsof. This enables transfer of S-parameter data files from the network analyzer directly into microwave design simulation environment.



On-wafer measurements to 110 GHz with the ME7808B

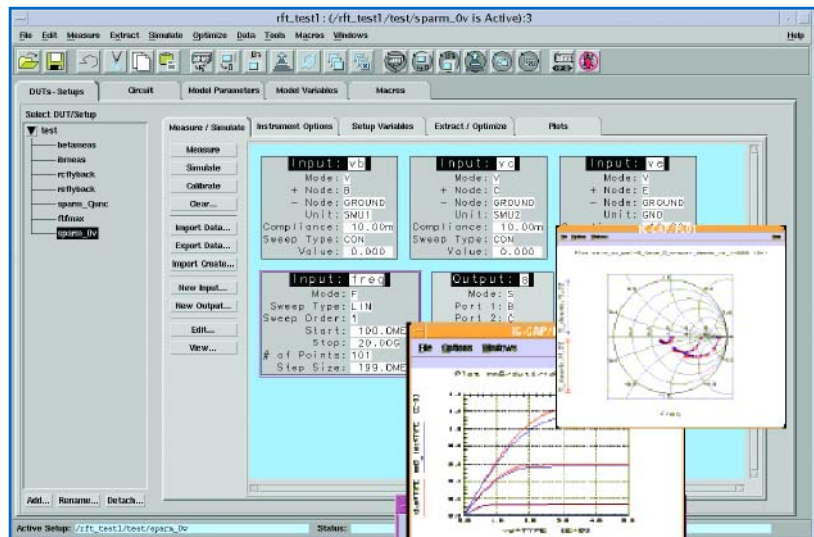

Design Simulation with IC-CAP

# Vector Network Analyzers that offer . . .

## Microstrip Devices

In addition to on-wafer measurements, the Lightning D VNAs can measure both microstrip and coplanar waveguide (CPW) designs when used with the available 3680 series Universal Test Fixture (UTF), microstrip calibration and verification kits. Early designs can be completely characterized with built-in Line-Reflect-Line (LRL) and Line-Reflect-Match (LRM) calibration capability. The four sampler design of the receiver provides true LRL/LRM error-correction resulting in accurate results for in-fixture devices. Highly reflective devices, along with well matched ones can be measured with the same degree of ease. Automatic dispersion compensation feature also improves measurement accuracy to help determine accurate phase of these devices.

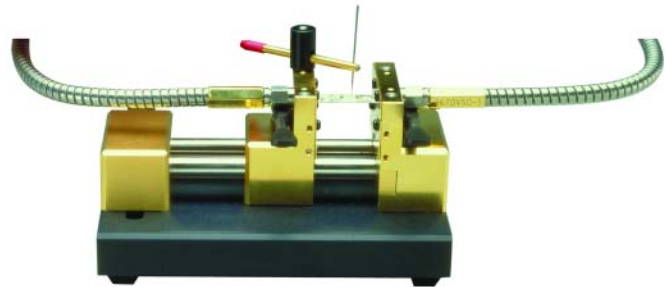

3680 Universal Test Fixture

## Multiport and Balanced/Differential

There are two configurations of multiport systems available, 20 GHz and 65 GHz, for characterizing multiport devices such as diplexers, isolators, directional couplers, differential transmission lines and components. The multiport system consists of an external test set and application software that is run on an external PC that controls the multiport test set, handles true four-port calibrations or multiple two-port calibrations, and displays measurement results in a variety of formats.



37397D Lightning VNA with Multiport Test Set

# ..... configuration flexibility

## Broadband

The ME7808B Broadband VNA offers single sweep broad frequency coverage from 40 MHz to 110 GHz. The Broadband VNA integrates a Lightning 37397D VNA, two Anritsu synthesizers, a broadband test set, two multiplexing couplers and extended W band (WR-10) modules to generate the fast broadband sweep.

The ME7808B is an ultra-flexible, high performance VNA ideal for broadband on-wafer device characterization, as well as banded waveguide or coaxial measurements.

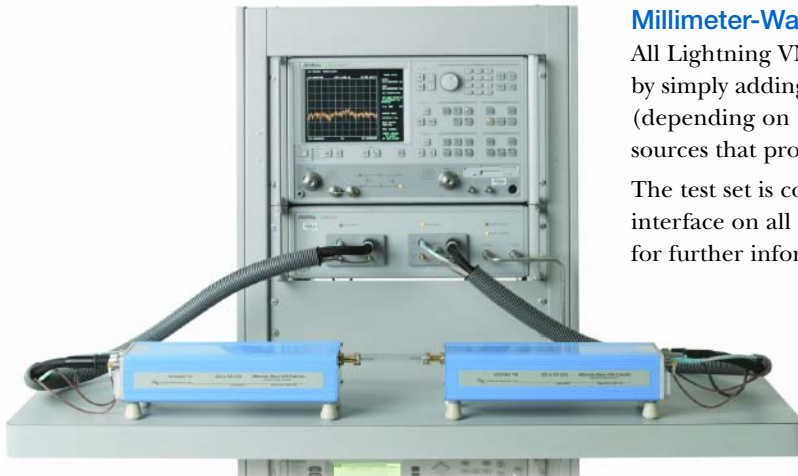

## Millimeter-Wave

All Lightning VNAs can be upgraded to a millimeter-wave VNA by simply adding a broadband test set, two millimeter-wave modules (depending on the desired frequency range) and two external CW sources that provide stimulus to the millimeter-wave modules.

The test set is connected to the Rear panel IF inputs, a standard interface on all 37000D VNAs. Please see the ME7808B brochure for further information.

## VNA Selection Guide by Application

Measurement Application	VNA Models	Options
2-port Passive (filters, attenuators, circulators)	37200D	
2-port Passive and Active (Amplifier, Mixers, Downconverter)	37300D	15 (recommended)
Multiport and Balanced (Duplexers, Couplers, Signal Integrity)	37200D/37300D with external multiport test set	15 (for 65 GHz multiport test set)
Millimeter-wave and Broadband (40 MHz to 110 GHz) Waveguide, On-wafer FETs or MMICs	ME7808B	
Antennas	37200D/37300D	15

# The Lightning™ 37000D

## Four Independent Display Channels

View all four S-parameters simultaneously or a single parameter in four different displays. Each channel's scaling, format, and domain settings are defined independently.

## Four Sampler Design

Achieve maximum accuracy for on-wafer applications requiring accurate LRL/LRM calibrations using 37000D's standard four-sampler architecture.

## Flexible Calibration

Popular calibration methods and connector types are easily selected during the automated calibration sequence. These analyzers guide you through the complete calibration process to minimize operator error.

## Internally Controlled AutoCal®

Built-in software support for the Anritsu AutoCal module. Simplify instrument setup, speed calibration, enhance measurement accuracy.

## Ethernet Access **New!**

The standard ethernet interface allows faster data transfer and remote connectivity.

## Embedding/De-embedding **New!**

The standard application included with every 37000D allows removal of fixture characteristics for calibrated in-fixture measurements and other applications.

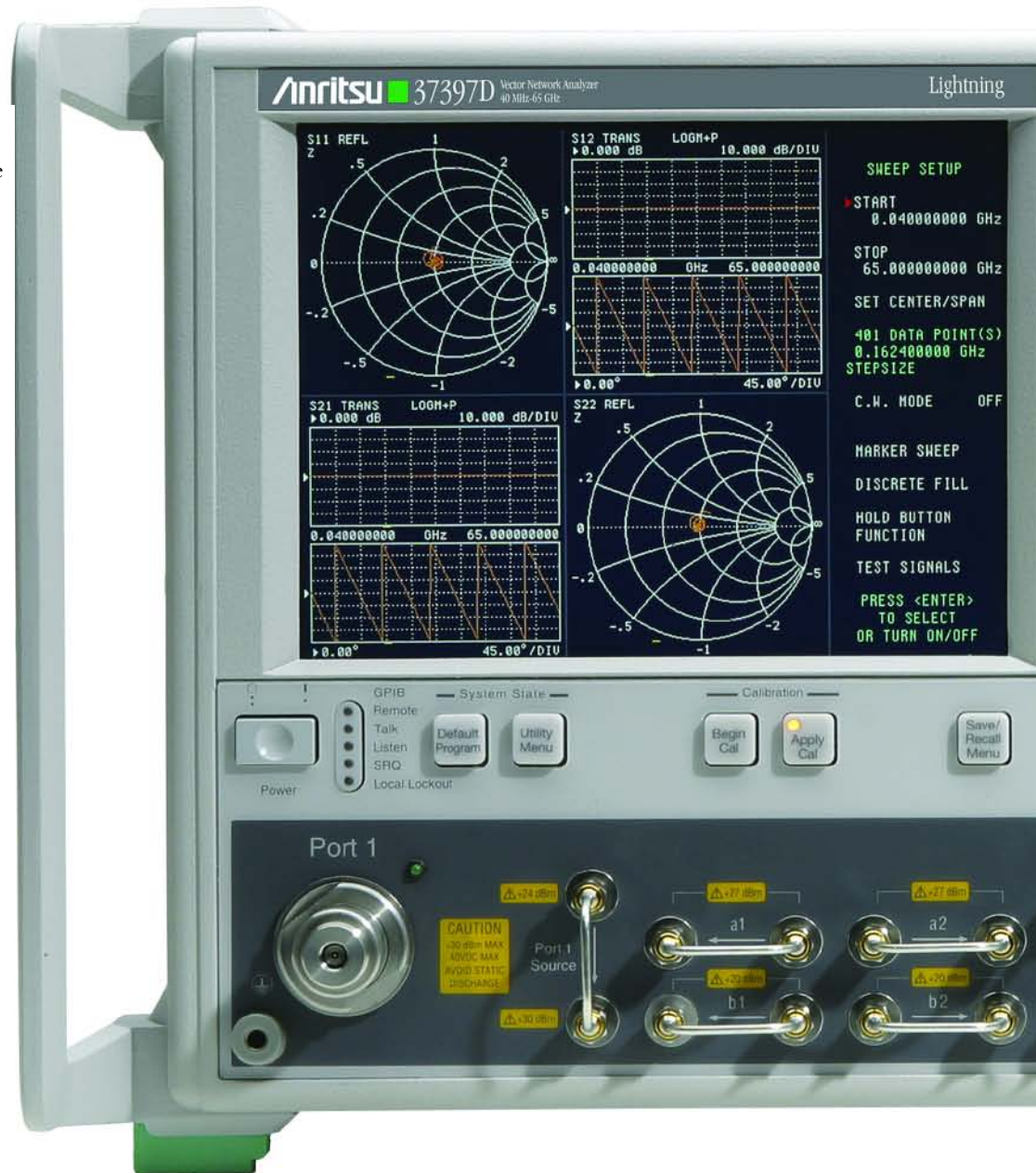



# Vector Network Analyzer

## NxN Application **New!**

The standard NxN mixer application enables error corrected measurements of Conversion Loss, Match and Group Delay for mixers.

## Improved Dynamic Range **New!**

The Lightning 37000D VNAs have improved dynamic range and output power to satisfy the measurement needs of passive and active devices.

## Flexible Test Set **New!**

Rear panel IF inputs are standard on all 37000D VNAs to allow for upgrade to mmW operation. Additionally, Option 15 allows direct access to all four channels for frequency translated measurements, receiver antenna measurements, and integration of external test sets such as multiport.

## Software Compatibility

The 37000D VNAs can be easily integrated into ATE environments via use of available software utilities. Features such as S2P file formats for simulation, and DLL's for ATE programming are provided for use with commercially available software packages.

## Upgradeability

Each analyzer in the 37000D family can be upgraded in frequency (up to 325 GHz) and capability. Your analyzer investment is protected as measurement demands increase.

## Three-Year Factory Warranty

All 37000D VNAs are backed with a "no questions asked" three-year warranty.



# Vector Network Analyzers that offer . . .

## Ethernet

The 10BASE-T Ethernet interface allows remote access to all of the resources in Lightning via LAN/Ethernet through a standard RJ-45 connector. In addition, the VNA Utilities CD includes a suite of programs that allow transfer of data and files and simplifies programming over the Ethernet interface.

The network setup menu guides the user through the configuration steps necessary (set IP address and subnet mask) to connect the Lightning D VNA onto a network. Most of the commands supported over GPIB are available over Ethernet. The syntax of the commands is unchanged and the data returned is in the same format as GPIB.

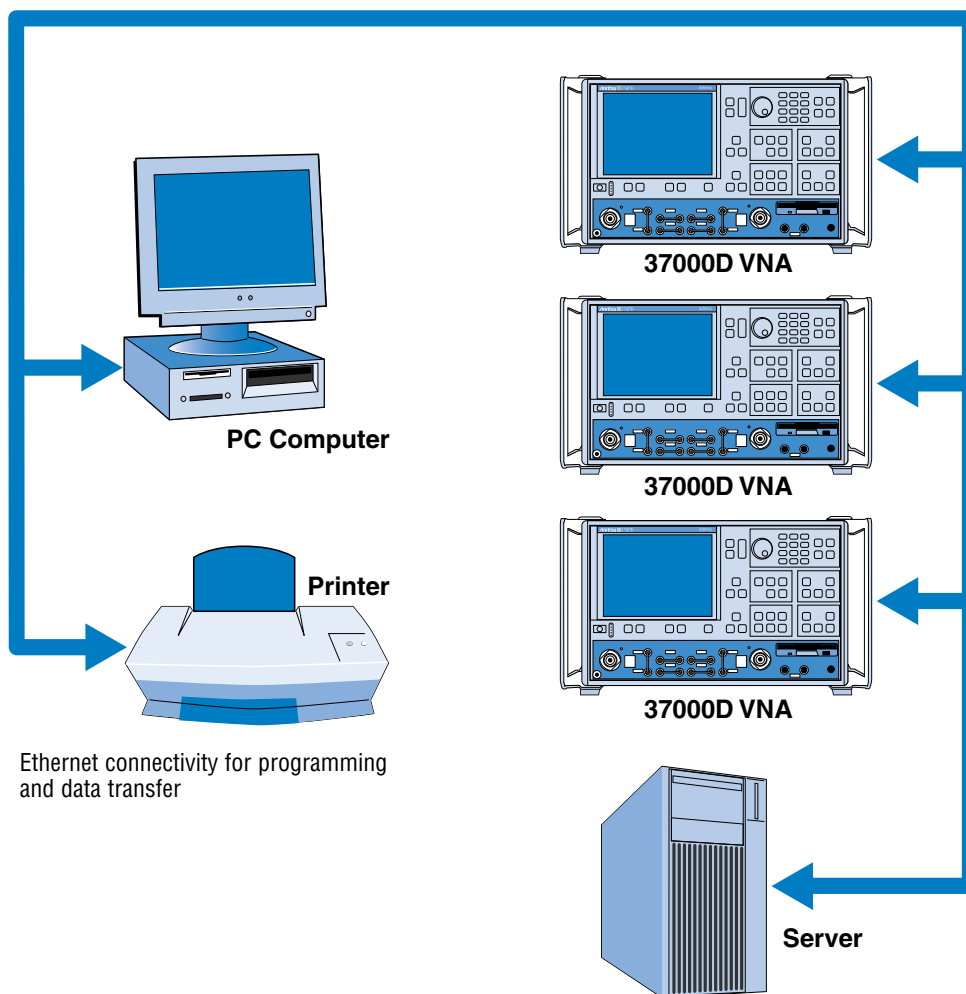

# ..... complete connectivity

## GPIB

The 37000D VNAs are equipped with two GPIB interfaces, **Standard** and **Dedicated**. The Standard port (IEEE 488.2) allows control of the VNA via an external controller such as the PC, while the Dedicated port allows control of external test equipment such as Power meter, Synthesizer, etc., through the VNA for use in a variety of applications

## Serial

The Serial port interface is primarily provided for control of the Autocal<sup>®</sup> module. The Anritsu AutoCal automatic calibrator is designed to speed and simplify the calibration of your Lightning VNA.

## Parallel

Also designated as the External I/O connector, the parallel port provides I/O access for Channels 1 through 4, limit settings and Port 1 and 2 bias voltages. This also allows control of TTL signals to external test sets.

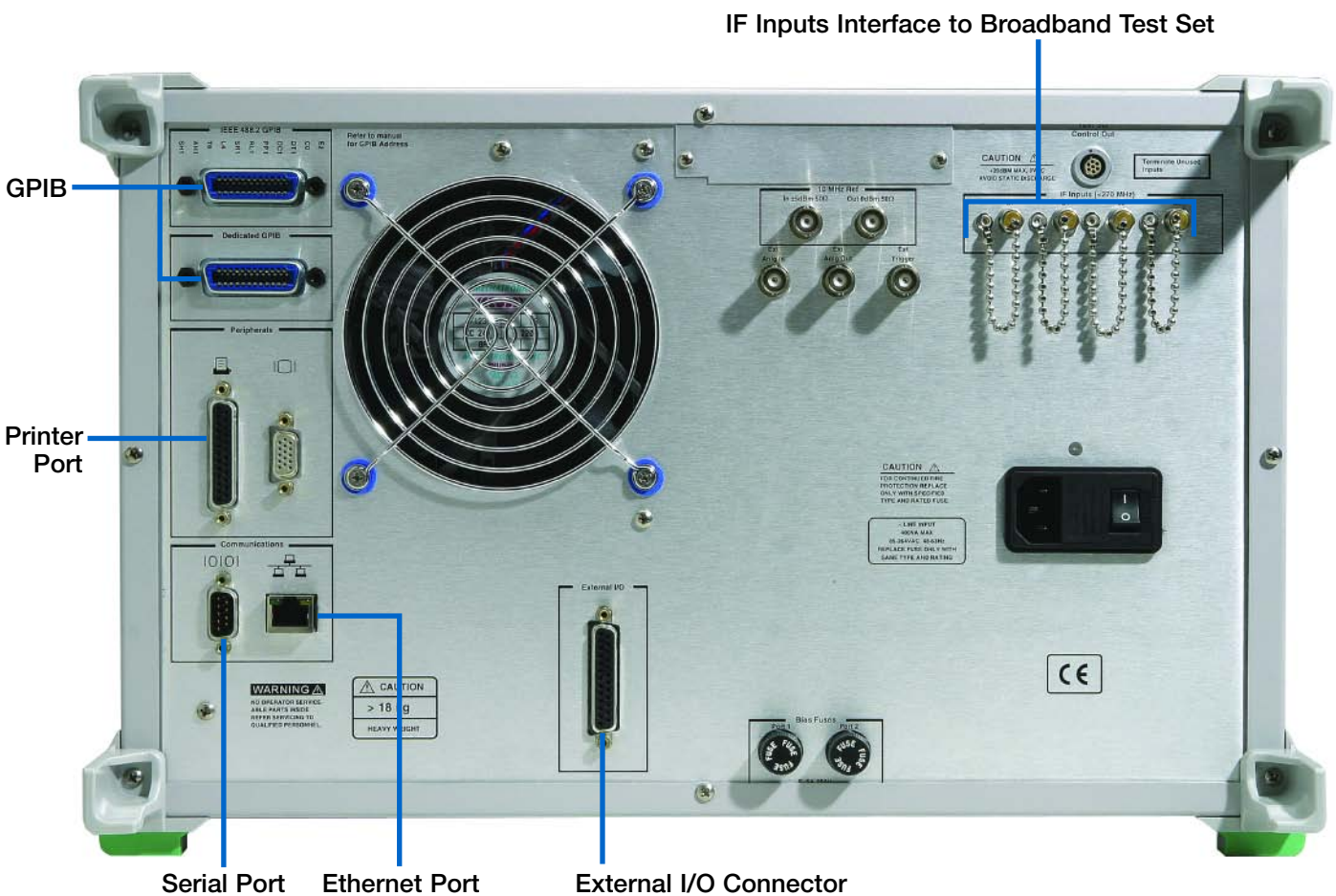

# Vector Network Analyzers that offer . . .

## VNA Utilities Software

The VNA Utilities Software is the ultimate solution for automated test software development. It includes fully functional application programs, re-usable calibration, set-up and data manipulation samples, and software development tools for creating custom applications. VNA Utilities is comprised of a simple, language independent, Windows® interface with a set of dynamic link libraries (DLLs). It can be called from any Windows® based development tool or application that supports programmability.

The VNA utilities CD also consists of the following programs that are accessible over the Ethernet or GPIB from an external PC.

**Capture Utility**, which allows the user to extract data off the VNA in any of the supported formats (bitmap, S2P, plotter graphics, etc.)

**Calkit File Maker** helps create a custom calibration disk readable into the 37000D VNA from the coefficients entered by the user.

**VNA Utility** manages system software downloads and data file uploads to/from the VNA's hard disk via a PC.

**VNA FTP Utility** allows managing the VNAs hard disk and transferring of files between the VNA and the PC.

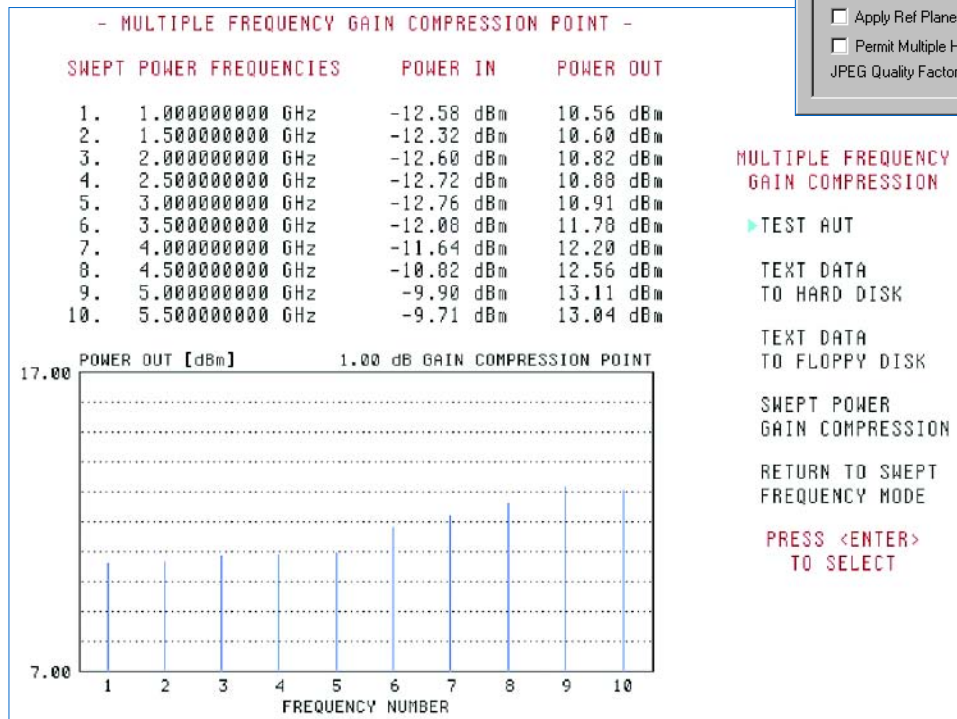
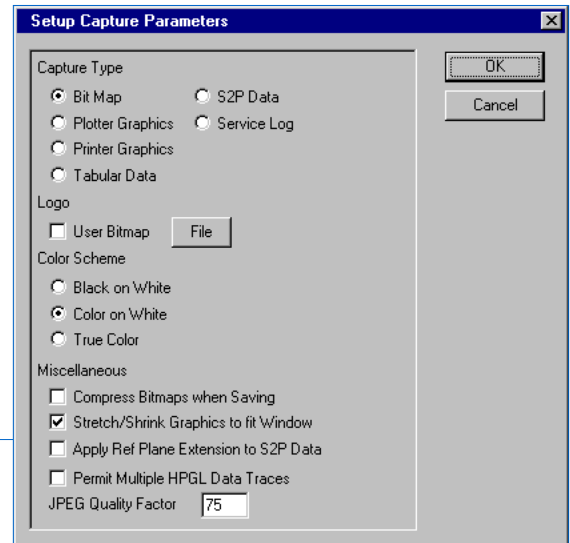

VNA Capture Utility and a bitmap snapshot



# ..... simple data extraction and automation

**Lightning Command Encyclopedia** is a program consisting of all the GPIB commands for programming the VNA in a searchable database form for simplified programming.

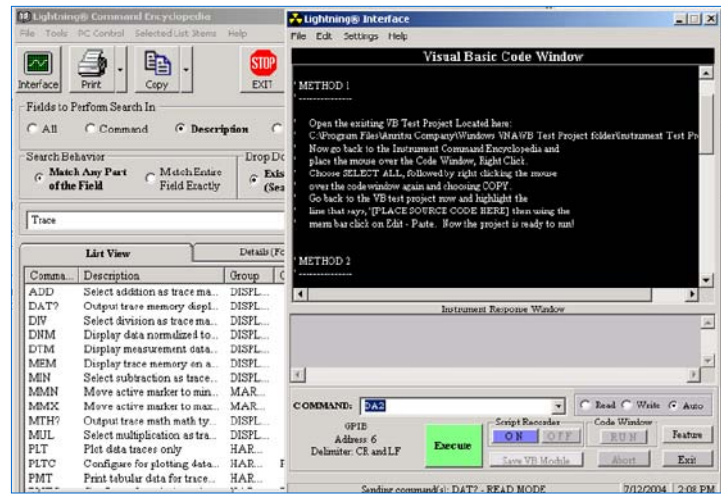

Lightning Command Encyclopedia

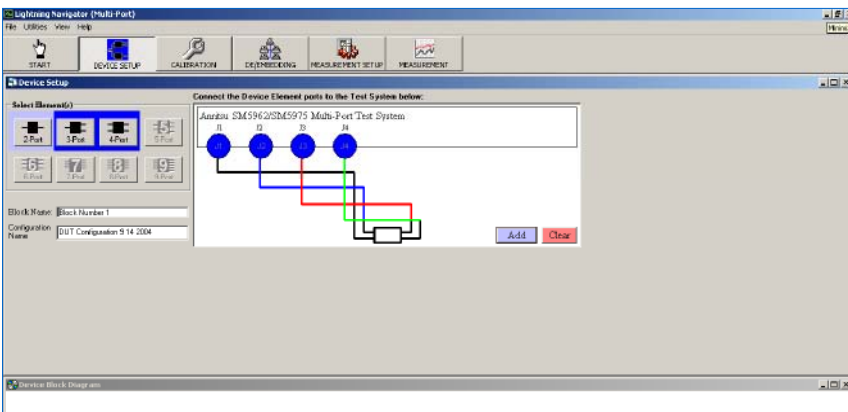

**Lightning Navigator™** is a Windows OS based application interface that guides the user easily through the process of calibrating and performing measurements.

The Navigator also includes **Ready-to-Use ActiveX Modules** which act as application drivers enabling programmers to accelerate automated test development. These components plug into many popular programming environments such as Visual C++®, Visual Basic®, LabView™ and TestStand.

**Lightning Multiport Navigator™** is used with the available Multiport test sets for complete system control, enabling fast multiport calibrations and balanced differential measurement capability.

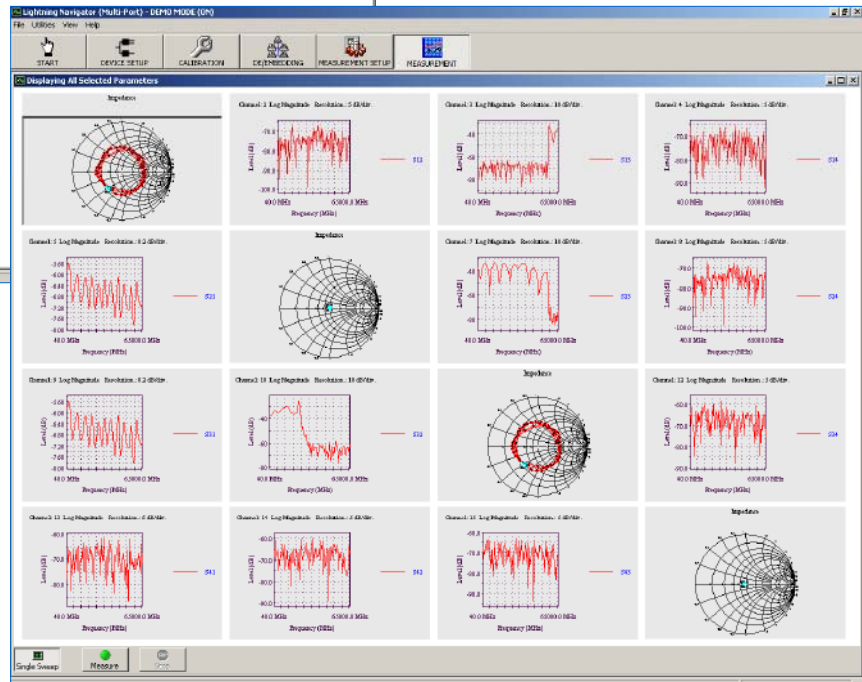

Lightning Multiport Navigator™ application

# Vector Network Analyzers that offer . . .

## Upgradeability

The 37000D Vector Network Analyzers are designed to accommodate higher frequency ranges and more powerful features as your requirements grow. Any 37000D model can be upgraded to any other model in the instrument family, to fit your changing requirements. Simply order the upgrade kit you need and an Anritsu Service Engineer will install the added capability and verify your system's total performance. Upgradeability is a cost-effective approach to satisfying today's needs, while providing the flexibility to meet tomorrow's demands. System software upgrades are as easy as inserting a disk into the instrument floppy drive.

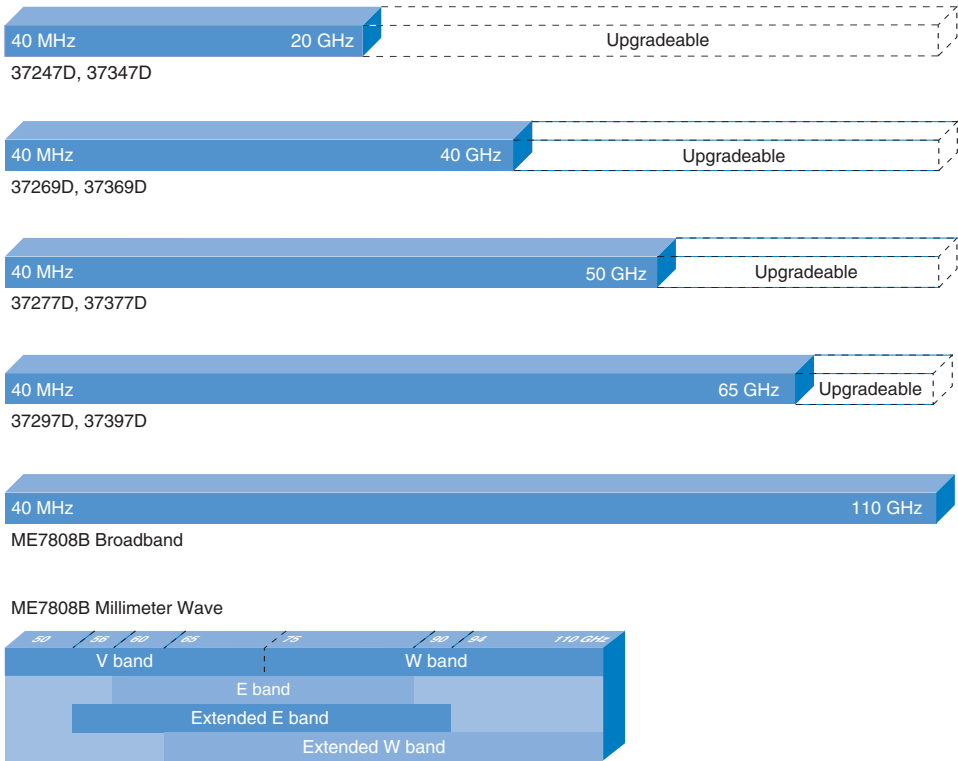

## Warranty and Extended Service

The 37000D family of vector network analyzers are backed by a standard return-to-service-center 3-year warranty. Extended Service Options are available to extend the warranty for up to 5 years as well as provide routine calibration. On-Site Service is also available at an additional cost in most regions of the world.

## Calibration Kits and Accessories

### 3650 and 3750 Series Calibration Kits

Accurate operation of your 37000D series analyzer is ensured by using Anritsu's precision coaxial OSLT (sliding load) calibration kits. These kits include precision components for calibrating measurements in GPC-7, type N, SMA, 3.5 mm, K Connector® and V Connector®. For waveguide measurements, standard kits offer offset-short calibration capabilities. Anritsu's microstrip calibration kits include all the components necessary for OSLT, LRL and LRM calibrations using the Anritsu 3680 series Universal Test Fixture.



3650 and 3750 Coaxial Calibration Kits (Sliding Load OSLT)

### 3658 Series AutoCal®

The Anritsu 3658 series AutoCal modules are automatic calibrators that provide fast, repeatable and high quality coaxial calibrations up to 40 GHz. These modules contain precisely characterized calibration standards that aid in the removal of normal systematic errors of Vector Network Analyzers. These calibrators are ideal for the manufacturing environment where speed, accuracy, and reliability are important.

With the aid of test port cable converter kits, a single module can calibrate insertable and non-insertable devices, as well as K, SMA, or 3.5 mm devices. AutoCal is directly driven by the VNA via a serial bus, sparing the use of an external controller.



3650 Series Waveguide Calibration Kits

### 3660 Series Verification Kits

Anritsu offers a complete line of coaxial verification kits to confirm your system's performance. All verification kits contain precision components with characteristics traceable to the US National Institute of Standards and Technology (NIST). Verification kits can be kept in your metrology laboratory where they provide the most dependable means of checking system accuracy.



3658 Series AutoCal module

### 3680 Series Universal Test Fixture (UTF)

Anritsu's Universal Test Fixture accommodates measurements in microstrip and coplanar waveguide. Spring-loaded jaws help to provide 0.1 dB repeatability on devices from 5 to 75 mils thick. Special fixtures are available for testing packaged transistors. An optional MMIC attachment helps you test integrated circuits.

### 3670 and 3671 Series Test Port Cables

Anritsu offers laboratory quality semi-rigid and flexible test port cables for GPC-7, N, 3.5 mm, K and V connectors.

### 34 Series Test Port Converters

Test port converters allow you to change the connectors on the VNA's test ports. Converters are available for GPC-7, type N, 3.5 mm, K and V connectors.



3660 Series Verification Kits

### 35 Series Waveguide to Coaxial Adapters

These precision waveguide-to-coax adapters transform standard or double-ridge waveguide to coaxial K or V connectors. Sixteen different models cover the 18 to 65 GHz frequency range.



3680 Series Universal Test Fixture



SALES CENTERS:

United States (800) ANRITSU

Canada (800) ANRITSU

South America 55 (21) 2527-6922

Europe 44 (0) 1582-433433

Japan 81 (46) 223-1111

Asia-Pacific (65) 6282-2400

Microwave Measurements Division

490 Jarvis Drive, Morgan Hill, CA 95037-2809

<http://www.us.anritsu.com>