

# Agilent 2-Port PNA-L Microwave Network Analyzer

**Please note:** This document *does not* contain Agilent's most up-to-date PNA-L network analyzer portfolio. This document is available for reference only for customers using Agilent's legacy network analyzers. To view the current Agilent 2-port PNA-L Microwave Network Analyzer Data Sheet [click here](#).

**N5230A**  
**300 kHz to 6, 13.5 GHz**  
**10 MHz to 20, 40, 50 GHz**  
Data Sheet

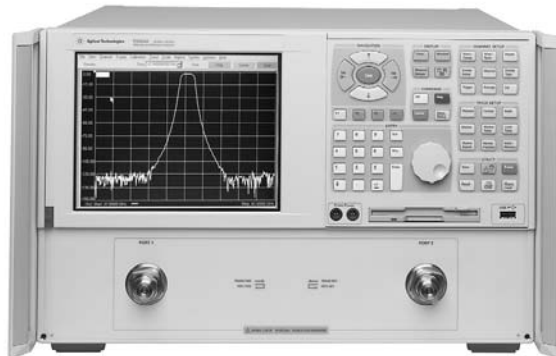
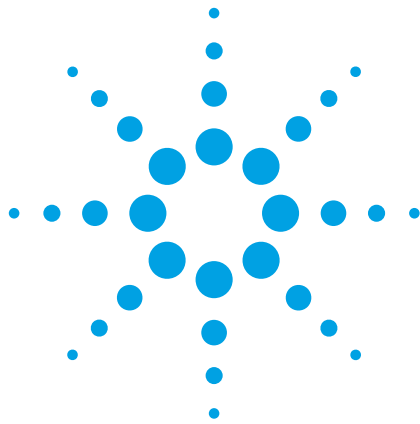

**Note:**  
Specification information in this document is also available within the PNA-L network analyzer's internal Help system.

# Table of Contents

<b>Definitions</b> .....	<b>3</b>
<b>Corrected System Performance</b> .....	<b>4</b>
Table 1. System dynamic range .....	4
Table 2. Extended dynamic range .....	5
N5230A Corrected system performance with 3.5mm connectors .....	6
Table 3. 85052B Calibration kit N5230A – Configuration test set and extended power range (Option 025 or 125) ..	6
Table 4. 85052B Calibration kit N5230A – Configuration test set and extended power range (Option 225) .....	8
Table 5. N4691A Electronic calibration module N5230A – Configuration test set and extended power range (Option 225) .....	10
Table 6. 85056A Calibration kit N5230A – Configuration test set and extended power range (Option 425 or 525) .....	12
Table 7. N4693A Electronic calibration module N5230A – Configuration test set and extended power range (Option 425 or 525) .....	14
N5230A Corrected system performance with Type-N connectors .....	16
Table 8. N5232B Calibration kit N5230A – Configuration test set and extended power range (Option 025) .....	16
Table 9. Uncorrected system performance .....	18
Table 10. Test port output .....	19
Table 11. Test port input .....	21
<b>Dynamic Accuracy</b> .....	<b>25</b>
Table 12. Test port input (group delay) .....	25
<b>General Information</b> .....	<b>26</b>
Table 13. Miscellaneous information .....	26
Table 14. Front panel information .....	26
Table 15. Rear panel information .....	27
Table 16. Analyzer environment and dimensions .....	28
<b>Measurement Throughput Summary</b> .....	<b>29</b>
Table 17. Typical cycle time (ms) for measurement completion .....	29
Table 18. Cycle time vs IF bandwidth (Options 020, 025, 120, 125) .....	30
Table 19. Cycle time vs IF bandwidth (Options 220, 225, 420, 425) .....	31
Table 20. Cycle time vs number of points (Options 020, 025, 120, 125) .....	32
Table 21. Cycle time vs number of points (Options 220, 225, 420, 425, 520, 525) .....	33
Table 22. Data transfer time (ms) .....	34
<b>Specifications: Front-Panel Jumpers</b> .....	<b>35</b>
Table 23. Measurement receiver inputs (Rcvr A In, Rcvr B In) .....	35
Table 24. Reference receiver inputs (Rcvr R1, Rcvr R2) .....	36
Table 25. Reference outputs (Reference 1 Source out, Reference 2 Source Out) .....	36
Table 26. Source outputs (Port 1 source out, Port 2 Source Out) .....	37
Table 27. Coupler inputs (port 1 Cplr Thru, Port 2 Cplr Thru) .....	37
Table 28. Coupler outputs (port 1 Cplr Arm, Port 2 Cplr Arm) .....	37
<b>Test Set Block Diagrams</b> .....	<b>38</b>
N5230A Option 220, or 420, or 520 (standard test set and standard power range) network analyzer .....	38
N5230A Option 225, or 425, or 525 (configurable test set and extended power range) network analyzer ..	38
<b>Web Resources</b> .....	<b>39</b>

---

This is a subset of technical specifications for the N5230A network analyzer.

To view or print the N5230A technical specifications, visit our web site at [www.agilent.com/find/pnal](http://www.agilent.com/find/pnal)

This N5230A document provides technical specifications for the following calibration kits and ECal modules only: 85052B, 85056A, 85032B, N4691A, and N4693A. Please download our free Uncertainty Calculator from [www.agilent.com/find/na\\_calculator](http://www.agilent.com/find/na_calculator) to generate the curves for your calibration kit and PNA setup.

---

## Definitions

All specifications and characteristics apply over a 25 °C  $\pm$ 5 °C range (unless otherwise stated) and 90 minutes after the instrument has been turned on.

**Specification (spec.):** Warranted performance. Specifications include guardbands to account for the expected statistical performance distribution, measurement uncertainties, and changes in performance due to environmental conditions.

**Characteristic (char.):** A performance parameter that the product is expected to meet before it leaves the factory, but that is not verified in the field and is not covered by the product warranty. A characteristic includes the same guardbands as a specification.

**Typical (typ.):** Expected performance of an average unit which does not include guardbands. It is not covered by the product warranty.

**Nominal (nom.):** A general, descriptive term that does not imply a level of performance. It is not covered by the product warranty.

**Calibration:** The process of measuring known standards to characterize a network analyzer's systematic (repeatable) errors.

**Corrected (residual):** Indicates performance after error correction (calibration). It is determined by the quality of calibration standards and how well "known" they are, plus system repeatability, stability, and noise.

**Uncorrected (raw):** Indicates instrument performance without error correction. The uncorrected performance affects the stability of a calibration.

**Standard:** When referring to the analyzer, this includes no options unless noted otherwise.

## Corrected System Performance

The specifications in this section apply for measurements made with the N5230A analyzer with the following conditions:

- 10 Hz IF bandwidth
- No averaging applied to data
- Isolation calibration with an averaging factor of 8

**Table 1. System dynamic range<sup>1</sup>**

### Standard configuration and standard power range

Description	Specification (dB) at test port				Typical (dB) at test port			
	Option 020, 120	Option 220	Option 420	Option 520	Option 020, 120	Option 220	Option 420	Option 520
300 kHz to 3 MHz <sup>3</sup>	93 <sup>4</sup>							
3 to 10 MHz	113							
10 to 45 MHz	122				103	89	89	
45 to 70 MHz <sup>2</sup>	122	101	90	90				
70 to 500 MHz <sup>2</sup>	122	105	90	90				
500 MHz to 2 GHz	122	110	110	110				
2 to 6 GHz	122	110	110	110				
6 to 8 GHz	120	110	110	110				
8 to 9 GHz	120	110	100	100				
9 to 10.5 GHz	116	110	100	100				
10.5 to 12.5 GHz	111	110	100	100				
12.5 to 13.5 GHz	109	108	100	100				
13.5 to 20 GHz	108		100	100				
20 to 31.25 GHz			95	95				
31.25 to 40 GHz			90	90				
40 to 50 GHz			79					

### Configurable test set and extended power range

Description	Specification (dB) at test port				Typical (dB) at test port			
	Option 025, 125	Option 225	Option 425	Option 525	Option 025, 125	Option 225	Option 425	Option 525
300 kHz to 3 MHz <sup>3</sup>	92 <sup>4</sup>							
3 to 10 MHz	112							
10 to 45 MHz	121				103	88	88	
45 to 70 MHz <sup>2</sup>	121	101	90	90				
70 to 500 MHz <sup>2</sup>	121	105	90	90				
500 MHz to 2 GHz	121	110	110	110				
2 to 6 GHz	121	110	110	110				
6 to 8 GHz	120	110	110	110				
8 to 9 GHz	120	110	100	100				
9 to 10.5 GHz	116	110	100	100				
10.5 to 12.5 GHz	111	110	100	100				
12.5 to 13.5 GHz	108	108	100	100				
13.5 to 20 GHz	108		100	100				
20 to 31.25 GHz			92	92				
31.25 to 40 GHz			87	87				
40 to 50 GHz			75					

1. The system dynamic range is calculated as the difference between the noise floor and the specified source maximum output power. The effective dynamic range must take measurement uncertainties and interfering signals into account.
2. May be degraded typically by 10 dB at particular frequencies (multiples of 5 MHz) below 500 MHz due to spurious receiver residuals. Methods are available to regain the full dynamic range.
3. May be limited by crosstalk at certain frequencies below 3 MHz.
4. Value and frequency band changed July 2006.

Table 2. Extended dynamic range<sup>1</sup>

**Configurable test set and extended power range**

Description	Specification (dB) at direct receiver access input				Typical (dB) at direct receiver access input			
	Option 025, 125	Option 225	Option 425	Option 525	Option 025, 125	Option 225	Option 425	Option 525
300 kHz to 3 MHz <sup>3</sup>	108 <sup>4</sup>							
3 to 10 MHz	128							
10 to 45 MHz	137					115	109	109
45 to 70 MHz <sup>2</sup>	137	113	111	111				
70 to 500 MHz <sup>2</sup>	137	117	111	111				
500 MHz to 2 GHz	137	122	122	122				
2 to 6 GHz	137	122	122	122				
6 to 8 GHz	136	122	122	122				
8 to 9 GHz	136	122	122	122				
9 to 10.5 GHz	132	122	112	112				
10.5 to 12.5 GHz	127	122	112	112				
12.5 to 13.5 GHz	124	120	112	112				
13.5 to 20 GHz		120	112	112				
20 to 31.25 GHz			103	103				
31.25 to 40 GHz			98	98				
40 to 50 GHz				83				

1. The direct receiver access input extended dynamic range is calculated as the difference between the direct receiver access input noise floor and the source maximum output power. The effective dynamic range must take measurement uncertainties and interfering signals into account. This set-up should only be used when the receiver input will never exceed its compression or damage level. When the analyzer is in segment sweep mode, it can have predefined frequency segments which will output a higher power level when the extended dynamic range is required (i.e. devices with high insertion loss), and reduced power when receiver compression or damage may occur (i.e. devices with low insertion loss). The extended range is only available in one-path transmission measurements.
2. May be degraded typically by 10 dB at particular frequencies (multiples of 5 MHz) below 500 MHz due to spurious receiver residuals. Methods are available to regain the full dynamic range.
3. May be limited by crosstalk at certain frequencies below 3 MHz.
4. Value and frequency band changed July 2006.

## N5230A Corrected system performance with 3.5 mm connectors

**Table 3. 85052B Calibration kit**  
**N5230A – configurable test set and extended power range (Option 025, 125)**

### Configurable test set, extended power range

Applies to the N5230A Option 025.125 analyzers, 85052B (3.5 mm) calibration kit, 85131F flexible test port cable set, and a full 2-port calibration. Also applies to the following condition: Environmental temperature  $23^{\circ} \pm 3^{\circ} \text{C}$ , with  $< 1^{\circ} \text{C}$  deviation from calibration temperature.

Description	Specification (dB)			
	300 kHz to 10 MHz	10 MHz to 2 GHz	2 to 8 GHz	8 to 13.5 GHz
Directivity	48	48	44	44
Source match	40	40	33	31
Load match	48	48	44	44
Reflection tracking	$\pm 0.003$ (+0.02/°C)	$\pm 0.003$ (+0.02/°C)	$\pm 0.003$ (+0.03/°C)	$\pm 0.006$ (+0.03/°C)
Transmission tracking	$\pm 0.017$ (+0.02/°C)	$\pm 0.015$ (+0.02/°C)	$\pm 0.075$ (+0.03/°C)	$\pm 0.131$ (+0.03/°C)

### Transmission uncertainty (specifications)

#### Magnitude

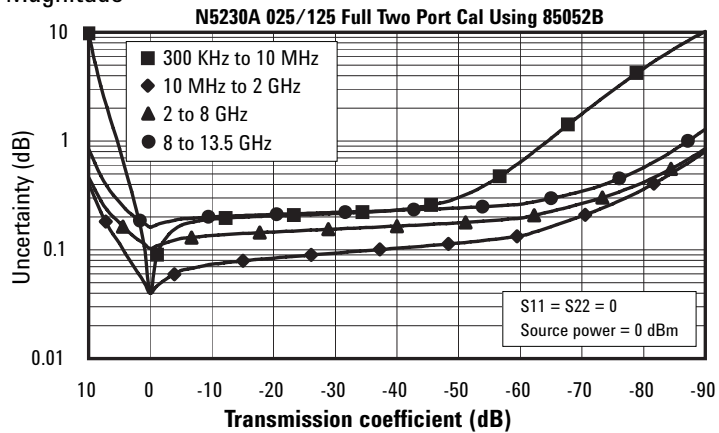

#### Phase

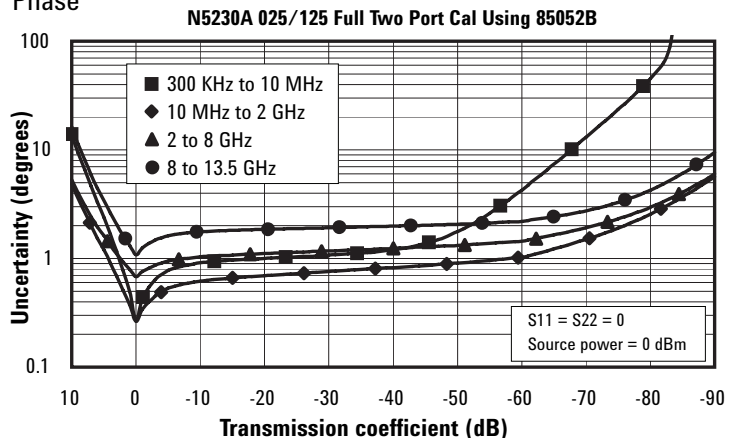

### Reflection uncertainty (specifications)

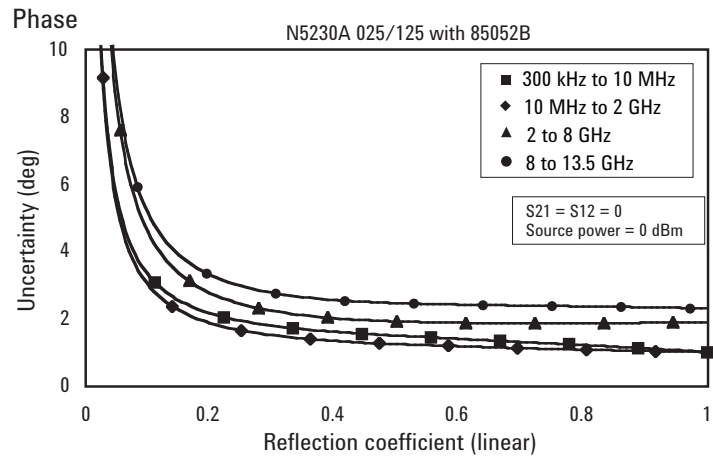
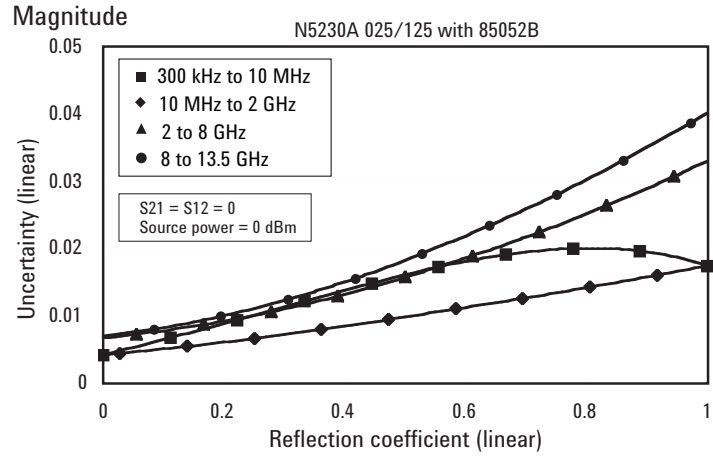

## N5230A Corrected system performance with 3.5 mm connectors

Table 4. 85052B Calibration kit

N5230A – configurable test set and extended power range (Option 225)

### Configurable test set, extended power range

Applies to the N5230A Option 225 analyzers, 85052B (3.5mm) calibration kit, 85131F flexible test port cable set, and a full 2-port calibration. Also applies to the following condition: Environmental temperature  $23^{\circ} \pm 3^{\circ} \text{C}$ , with  $< 1^{\circ} \text{C}$  deviation from calibration temperature.

Description	Specification (dB)			
	45 to 500 MHz	500 MHz to 2 GHz	2 to 8 GHz	8 to 20 GHz
Directivity	48	48	44	44
Source match	40	40	33	31
Load match	48	48	44	44
Reflection tracking	$\pm 0.003$ (+0.02/ $^{\circ}\text{C}$ )	$\pm 0.003$ (+0.02/ $^{\circ}\text{C}$ )	$\pm 0.003$ (+0.03/ $^{\circ}\text{C}$ )	$\pm 0.006$ (+0.03/ $^{\circ}\text{C}$ )
Transmission tracking	$\pm 0.010$ (+0.02/ $^{\circ}\text{C}$ )	$\pm 0.014$ (+0.02/ $^{\circ}\text{C}$ )	$\pm 0.062$ (+0.03/ $^{\circ}\text{C}$ )	$\pm 0.104$ (+0.03/ $^{\circ}\text{C}$ )

### Transmission uncertainty (specifications)

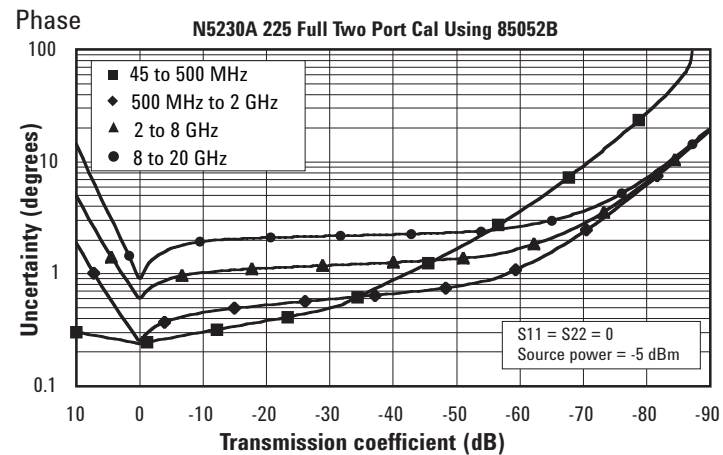
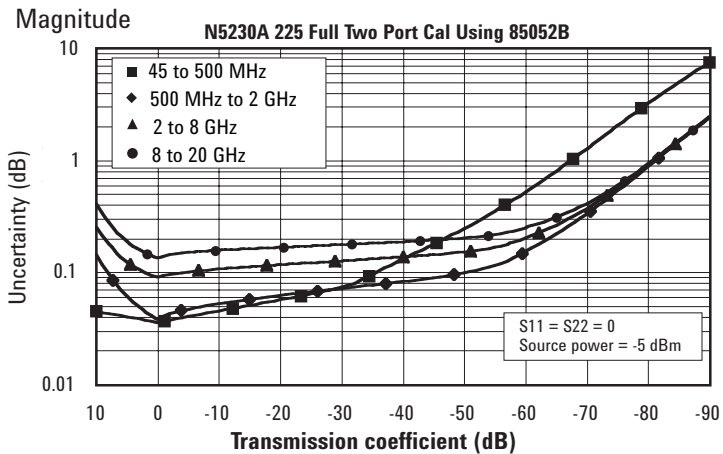



**N4691A Electronic calibration module**  
**N5230A – configurable test set and extended power range (Option 225)**

**Reflection uncertainty (specifications)**

Magnitude

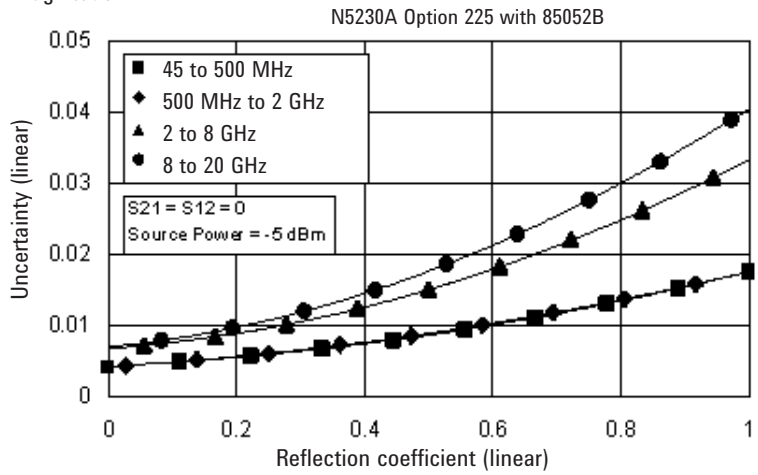

Phase

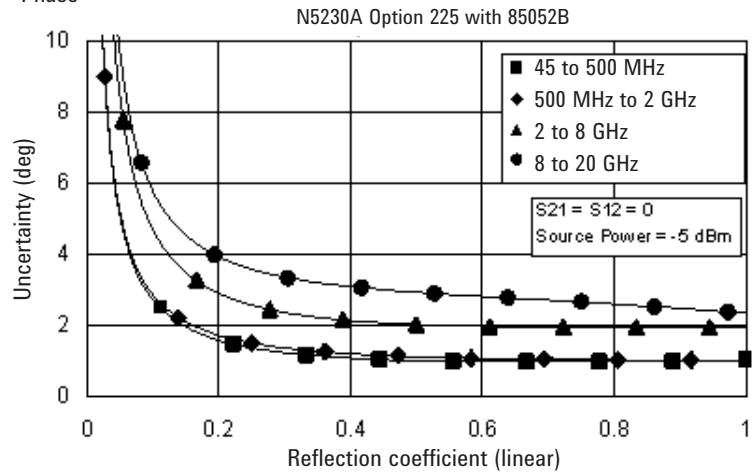

## N5230A Corrected system performance with 3.5 mm connectors

Table 5. N4691B Electronic calibration module

N5230A – configurable test set and extended power range (Option 225)

### Configurable test set, extended power range

Applies to the N5230A Option 225 analyzers, N4691B electronic calibration module, 85131F flexible test port cable set, and a full 2-port calibration. Also applies to the following condition: Environmental temperature  $23^{\circ} \pm 3^{\circ} \text{C}$ , with  $< 1^{\circ} \text{C}$  deviation from calibration temperature.

Description	Specification (dB)			
	45 to 500 MHz	500 MHz to 2 GHz	2 to 8 GHz	8 to 20 GHz
Directivity	46	56	54	48
Source match	41	47	45	44
Load match	41	47	44	42
Reflection tracking	$\pm 0.050$ ( $+0.02/^{\circ}\text{C}$ )	$\pm 0.020$ ( $+0.02/^{\circ}\text{C}$ )	$\pm 0.030$ ( $+0.03/^{\circ}\text{C}$ )	$\pm 0.040$ ( $+0.03/^{\circ}\text{C}$ )
Transmission tracking	$\pm 0.053$ ( $+0.02/^{\circ}\text{C}$ )	$\pm 0.021$ ( $+0.02/^{\circ}\text{C}$ )	$\pm 0.034$ ( $+0.03/^{\circ}\text{C}$ )	$\pm 0.052$ ( $+0.03/^{\circ}\text{C}$ )

### Transmission uncertainty (specifications)

#### Magnitude

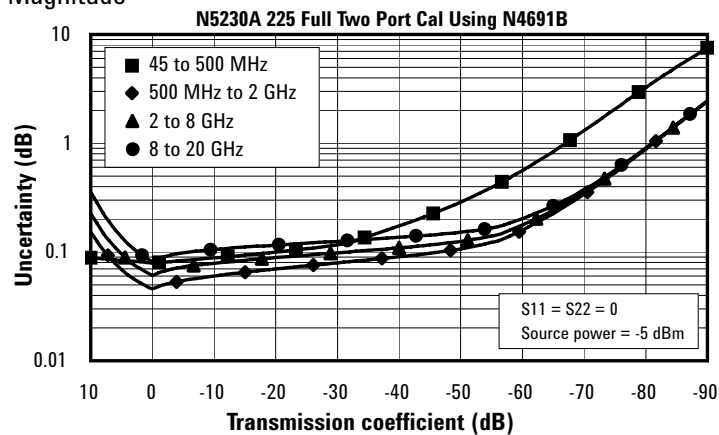

#### Phase

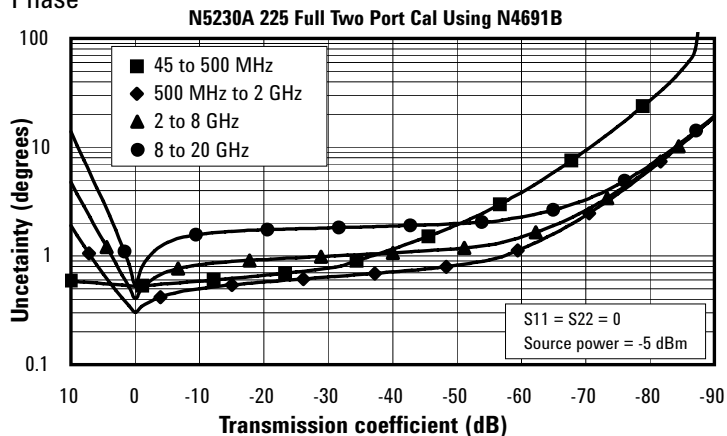

**N4691A Electronic calibration module**  
**N5230A – configurable test set and extended power range (Option 225)**

**Reflection uncertainty (specifications)**

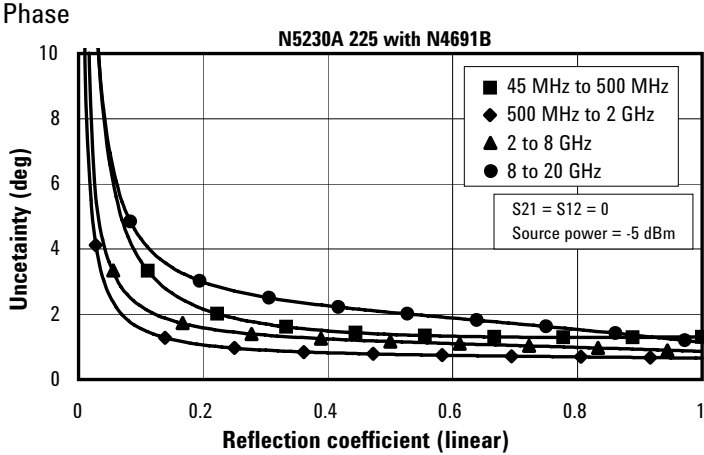
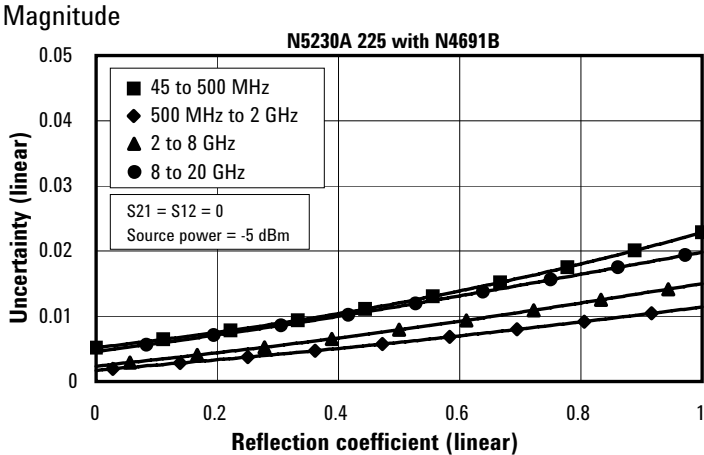

## N5230A Corrected system performance with 2.4 mm connectors

Table 6. 85056A Calibration kit

N5230A – configurable test set and extended power range (Option 425 or 525)

### Configurable test set, extended power range

Applies to the N5230A Option 425 or 525 analyzers, 85056A (2.4 mm) electronic calibration module, 85133F flexible test port cable set, and a full 2-port calibration. Also applies to the following condition: Environmental temperature  $23^\circ \pm 3^\circ \text{C}$ , with  $< 1^\circ \text{C}$  deviation from calibration temperature.

Description	Specification (dB)			
	45 MHz to 2 GHz	2 to 20 GHz	20 to 40 GHz	40 to 50 GHz
Directivity	42	42	38	36
Source match	41	38	33	31
Load match	42	42	37	35
Reflection tracking	$\pm 0.001$ (+0.02/ $^\circ\text{C}$ )	$\pm 0.008$ (+0.02/ $^\circ\text{C}$ )	$\pm 0.020$ (+0.02/ $^\circ\text{C}$ )	$\pm 0.027$ (+0.03/ $^\circ\text{C}$ )
Transmission tracking	$\pm 0.019$ (+0.02/ $^\circ\text{C}$ )	$\pm 0.057$ (+0.02/ $^\circ\text{C}$ )	$\pm 0.124$ (+0.02/ $^\circ\text{C}$ )	$\pm 0.211$ (+0.03/ $^\circ\text{C}$ )

### Transmission uncertainty (specifications)

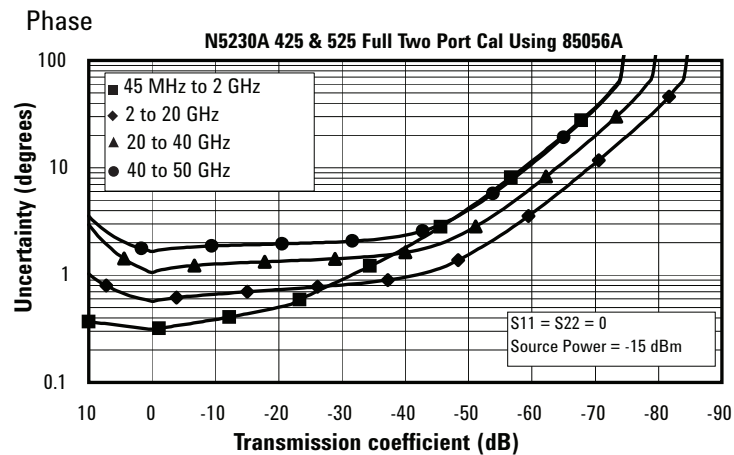
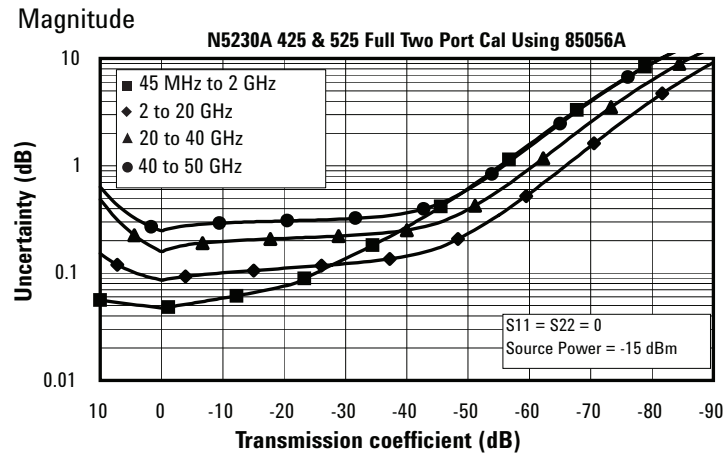

**Reflection uncertainty (specifications)**

**Magnitude**

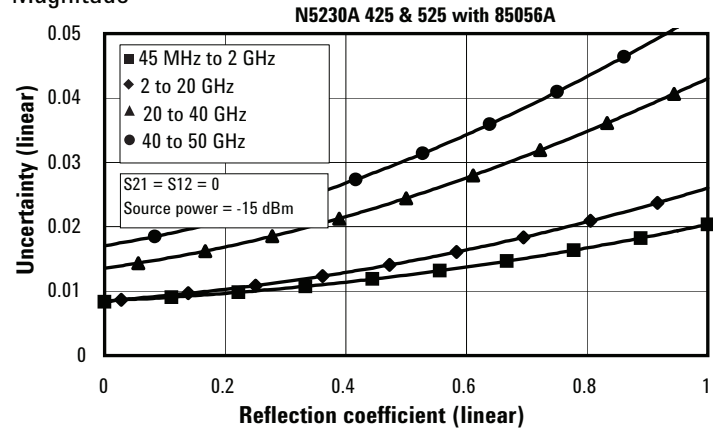

**Phase**

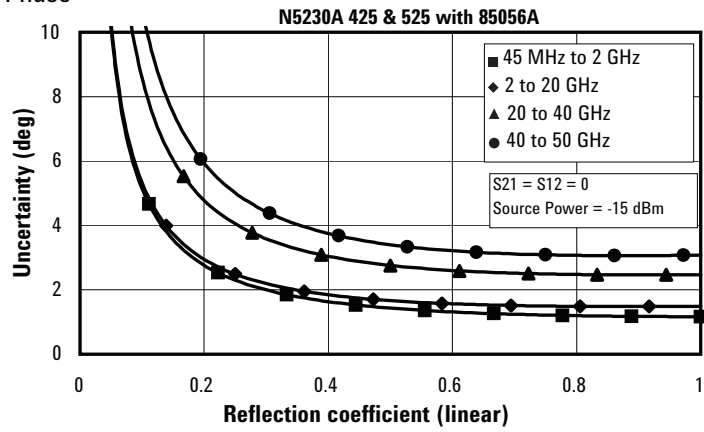

**Table 7. N4693A Electronic calibration module  
N5230A – configurable test set and extended power range (Option 425 or 525)**

**Configurable test set, extended power range**

Applies to the N5230A Option 425 or 525 analyzers, N4693A (2.4 mm) electronic calibration module, 85133F flexible test port cable set, and a full 2-port calibration. Also applies to the following condition: Environmental temperature  $23^{\circ} \pm 3^{\circ} \text{C}$ , with  $< 1^{\circ} \text{C}$  deviation from calibration temperature

Description	Typical (dB)	Specification (dB)			
	10 to 200 MHz	200 MHz to 2 GHz	2 to 20 GHz	20 to 40 GHz	40 to 50 GHz
Directivity	32	55	49	43	41
Source match	25	46	42	35	30
Load match	24	43	41	37	36
Reflection tracking	$\pm 0.05$ (+0.02/ $^{\circ}\text{C}$ )	$\pm 0.030$ (+0.02/ $^{\circ}\text{C}$ )	$\pm 0.040$ (+0.02/ $^{\circ}\text{C}$ )	$\pm 0.060$ (+0.02/ $^{\circ}\text{C}$ )	$\pm 0.080$ (+0.03/ $^{\circ}\text{C}$ )
Transmission tracking	$\pm 0.10$ (+0.02/ $^{\circ}\text{C}$ )	$\pm 0.056$ (+0.02/ $^{\circ}\text{C}$ )	$\pm 0.078$ (+0.02/ $^{\circ}\text{C}$ )	$\pm 0.107$ (+0.02/ $^{\circ}\text{C}$ )	$\pm 0.130$ (+0.03/ $^{\circ}\text{C}$ )

**Transmission uncertainty (specifications)**

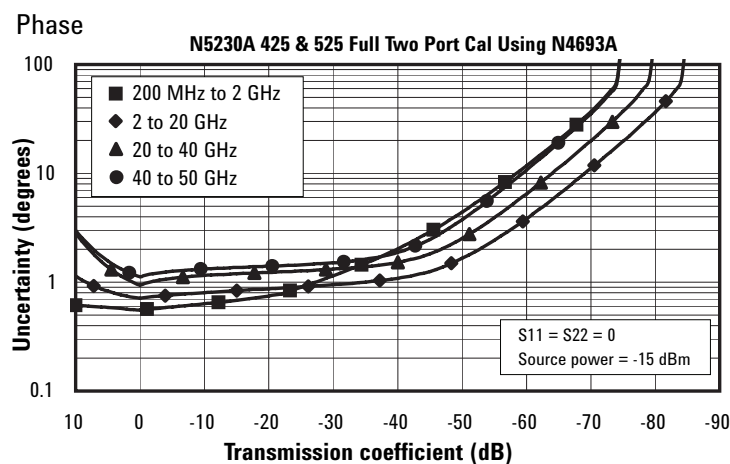
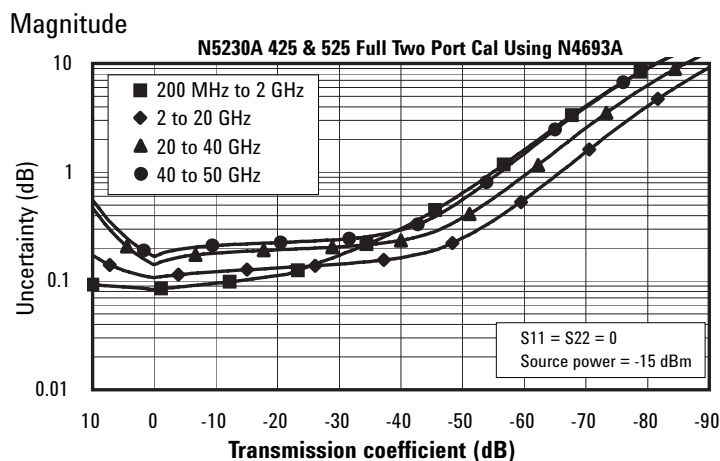

**Reflection uncertainty (specifications)**

**Magnitude**

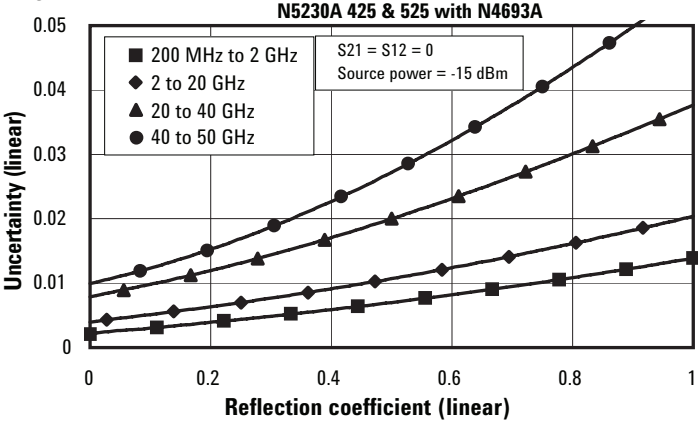

**Phase**

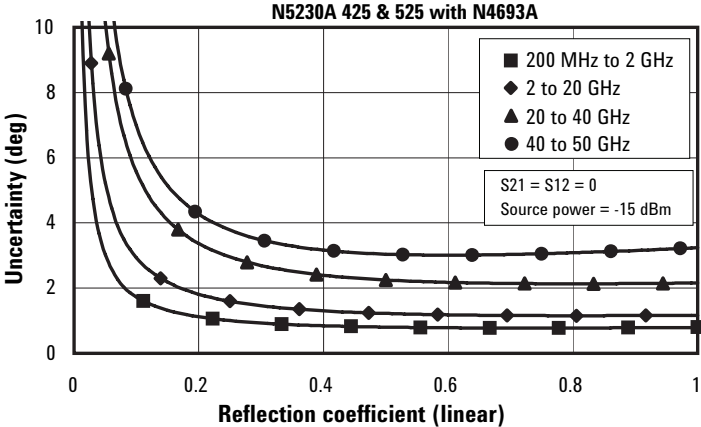

## N5230A Corrected system performance with Type-N connectors

Table 8. 85032B Calibration kit

N5230A – configurable test set and extended power range (Option 025)

### Configurable test set, extended power range

Applies to the N5230A Option 025 analyzers, 85032B (Type-N) calibration kit, 85132F flexible test port cable set with 85130C adapter set, and a full 2-port calibration. Also applies to the following condition: Environmental temperature  $23^{\circ} \pm 3^{\circ} \text{C}$ , with  $< 1^{\circ} \text{C}$  deviation from calibration temperature.

Description	Specification (dB)			
	300 kHz to 1 MHz	1 to 10 MHz	10 to 45 MHz	45 MHz to 6 GHz
Directivity	50	50	47	40
Source match	42	42	37	31
Load match	50	50	47	38
Reflection tracking	$\pm 0.009$ ( $+0.01/^{\circ}\text{C}$ )	$\pm 0.009$ ( $+0.01/^{\circ}\text{C}$ )	$\pm 0.019$ ( $+0.01/^{\circ}\text{C}$ )	$\pm 0.069$ ( $+0.02/^{\circ}\text{C}$ )
Transmission tracking	$\pm 0.013$ ( $+0.01/^{\circ}\text{C}$ )	$\pm 0.007$ ( $+0.01/^{\circ}\text{C}$ )	$\pm 0.021$ ( $+0.01/^{\circ}\text{C}$ )	$\pm 0.101$ ( $+0.02/^{\circ}\text{C}$ )

### Transmission uncertainty (specifications)

#### Magnitude

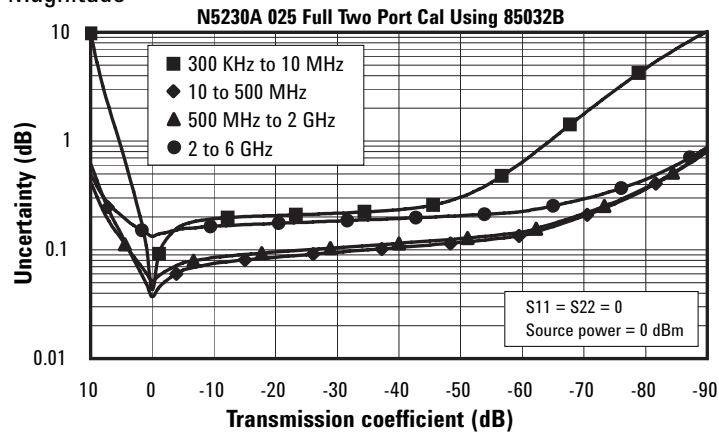

#### Phase

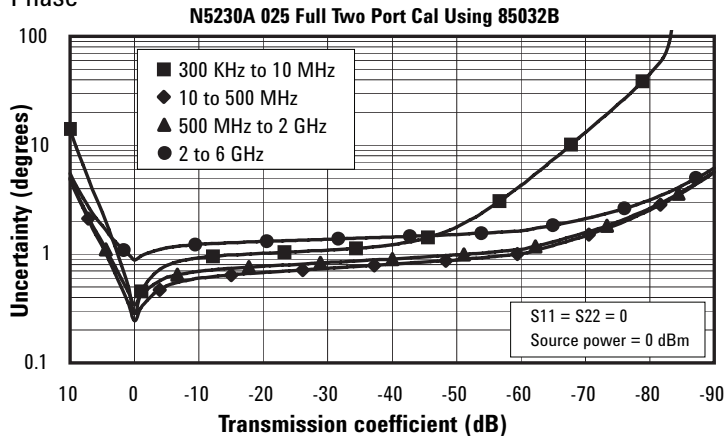



### Transmission uncertainty (specifications)

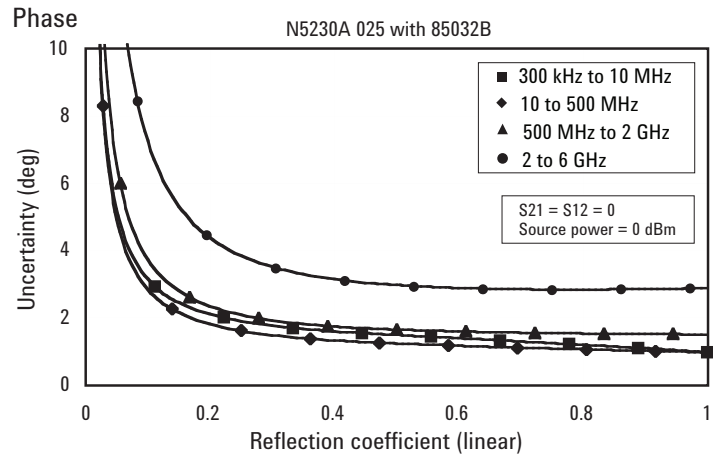
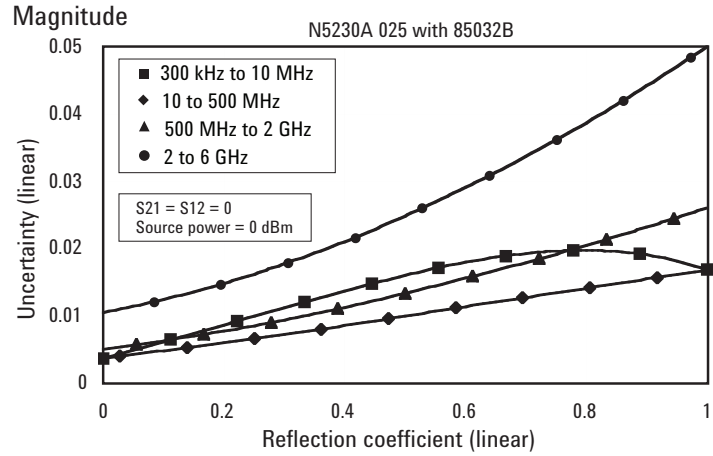

**Table 9. Uncorrected system performance**

Directivity	Specifications				Typicals			
	Option 020, 025, 120, 125	Option 220, 225	Option 420, 425	Option 520, 525	Option 020, 025, 120, 125	Option 220, 225	Option 420, 425	Option 520, 525
300 kHz to 10 MHz	16 dB							
10 to 45 MHz	28 dB					23 dB	20 dB	20 dB
45 to 500 MHz	28 dB	24 dB	23 dB	23 dB				
500 MHz to 1 GHz	28 dB	27 dB	23 dB	23 dB				
1 to 2 GHz	25 dB	27 dB	23 dB	23 dB				
2 to 3 GHz	25 dB	21 dB	21 dB	21 dB				
3 to 5 GHz	20 dB	21 dB	21 dB	21 dB				
5 to 8 GHz	17 dB	21 dB	21 dB	21 dB				
8 to 11.5 GHz	17 dB	16 dB	16 dB	16 dB				
11.5 to 13.5 GHz	15 dB	16 dB	16 dB	16 dB				
13.5 to 20 GHz		16 dB	16 dB	16 dB				
20 to 40 GHz			15 dB	15 dB				
40 to 50 GHz				13 dB				
<b>Source match</b>	<b>Option 020, 025, 120, 125</b>	<b>Option 220, 225</b>	<b>Option 420, 425</b>	<b>Option 520, 525</b>	<b>Option 020, 025, 120, 125</b>	<b>Option 220, 225</b>	<b>Option 420, 425</b>	<b>Option 520, 525</b>
300 kHz to 10 MHz	18 dB							
10 to 45 MHz	25 dB					12 dB	11 dB	11 dB
45 to 500 MHz	25 dB	20 dB	17 dB	17 dB				
500 MHz to 2 GHz	21 dB	17 dB	17 dB	17 dB				
2 to 3 GHz	19 dB	12 dB	12 dB	12 dB				
3 to 8 GHz	12 dB	12 dB	12 dB	12 dB				
8 to 9 GHz	12 dB	11 dB	11 dB	11 dB				
9 to 12.5 GHz	10 dB	11 dB	11 dB	11 dB				
12.5 to 13.5 GHz	8 dB	10 dB	11 dB	11 dB				
13.5 to 20 GHz		10 dB	11 dB	11 dB				
20 to 40 GHz			7 dB	7 dB				
40 to 50 GHz				6 dB				
<b>Load match</b>	<b>Option 020, 025, 120, 125</b>	<b>Option 220, 225</b>	<b>Option 420, 520</b>	<b>Option 425, 525</b>	<b>Option 020, 025, 120, 125</b>	<b>Option 220, 225</b>	<b>Option 420, 425</b>	<b>Option 520, 525</b>
300 kHz to 10 MHz	17 dB							
10 to 45 MHz	22 dB					15 dB	13 dB	13 dB
45 to 500 MHz	22 dB	22 dB	18 dB	18 dB				
500 MHz to 2 GHz	17 dB	20 dB	18 dB	18 dB				
2 to 3 GHz	14 dB	12 dB	14 dB	14 dB				
3 to 8 GHz	10 dB	12 dB	14 dB	14 dB				
8 to 9 GHz	9 dB	10 dB	12 dB	12 dB				
9 to 12.5 GHz	9 dB	10 dB	12 dB	12 dB				
12.5 to 13.5 GHz	7 dB	9 dB	9 dB	9.5 dB				
13.5 to 20 GHz		9 dB	9 dB	9.5 dB				
20 to 40 GHz			8 dB	8.5 dB				
40 to 50 GHz			5 dB	5 dB				
<b>Crosstalk<sup>1</sup></b>	<b>Option 020, 025, 120, 125</b>	<b>Option 220, 225</b>	<b>Option 420, 425</b>	<b>Option 520, 525</b>	<b>Option 020, 025, 120, 125</b>	<b>Option 220, 225</b>	<b>Option 420, 425</b>	<b>Option 520, 525</b>
300 kHz to 10 MHz					75 dB <sup>2</sup>			
10 to 45 MHz					115 dB	88 dB	88 dB	88 dB
45 to 500 MHz					122 dB	95 dB	94 dB	94 dB
500 MHz to 2 GHz					122 dB	96 dB	95 dB	95 dB
2 to 8 GHz					122 dB	110 dB	108 dB	108 dB
8 to 10.5 GHz					120 dB	116 dB	113 dB	113 dB
10.5 to 12.5 GHz					115 dB	116 dB	113 dB	113 dB
12.5 to 13.5 GHz					109 dB	115 dB	112 dB	112 dB
13.5 to 20 GHz						115 dB	112 dB	112 dB
20 to 40 GHz							97 dB	97 dB
40 to 50 GHz								89 dB

1. Measurement conditions: normalized to a thru, measured with two shorts, 10 Hz IF bandwidth, averaging factor of 8, alternate mode, source power set to the specified maximum power output or the minimum receiver input power specified by the 0.1 dB compression power.

2. Value changed July 2006.

Table 10. Test port output<sup>1</sup>

Description	Specifications					Typicals			
	Option 020, 025	Option 120, 125	Option 220, 225	Option 420, 425	Option 520, 525	Option 020, 025, 120, 125	Option 220, 225	Option 420, 425	Option 520, 525
<b>Frequency range</b>									
<b>N5230A</b>	300 kHz to 6 GHz	300 kHz to 13.5 GHz	10 MHz to 20 GHz	10 MHz to 40 GHz	10 MHz to 50 GHz				
<b>Nominal power</b>	Preset power; attenuator switch point 10 dB below nominal power								
	0 dBm	0 dBm	-5 dBm	-10 dBm	-15 dBm				
<b>Frequency resolution</b>	1 Hz								
<b>CW accuracy</b>	±1 ppm								
<b>Frequency stability</b>	±0.05 ppm. -10° to 70° C ±0.1 ppm/yr maximum								

Description	Specifications					Typicals			
	Option 020, 025, 120, 125	Option 220, 225	Option 420, 425	Option 520	Option 525	Option 020, 025, 120, 125	Option 220, 225	Option 420, 425, 520, 525	
<b>Power level accuracy</b>	Variation from nominal power in range 0								
300 kHz to 10 MHz	±1.0 dB								
10 to 45 MHz	±1.0 dB							±0.5 dB	±0.5 dB
45 MHz to 6 GHz	±1.0 dB	±1.0 dB	±1.0 dB	±1.0 dB	±1.0 dB				
6 to 8 GHz	±1.5 dB	±1.0 dB	±1.0 dB	±1.0 dB	±1.0 dB				
8 to 9 GHz	±1.5 dB	±1.0 dB	±1.5 dB	±1.5 dB	±1.5 dB				
9 to 10.5 GHz	±1.5 dB	±1.0 dB	±1.5 dB	±1.5 dB	±1.5 dB				
10.5 to 13.5 GHz	±2.0 dB	±1.0 dB	±1.5 dB	±1.5 dB	±1.5 dB				
13.5 to 20 GHz	±1.0 dB		±1.5 dB	±1.5 dB	±1.5 dB				
20 to 40 GHz				±2.5 dB	±2.5 dB				
40 to 50 GHz					±3.5 dB				

Description	Specifications							Typicals
	Option 020, 120	Option 025, 125	Option 220, 225	Option 420	Option 425	Option 520	Option 525	Option 220, 225
<b>Max leveled power</b>								
300 kHz to 10 MHz	10 dBm	9 dBm						
10 to 45 MHz	10 dBm	9 dBm						5 dBm
45 MHz to 6 GHz	10 dBm	9 dBm	5 dBm	0 dBm	0 dBm	0 dBm	0 dBm	
6 to 9 GHz	8 dBm	8 dBm	5 dBm	0 dBm	0 dBm	0 dBm	0 dBm	
9 to 12.5 GHz	4 dBm	4 dBm	5 dBm	0 dBm	0 dBm	0 dBm	0 dBm	
12.5 to 13.5 GHz	2 dBm	1 dBm	3 dBm	0 dBm	0 dBm	0 dBm	0 dBm	
13.5 to 20 GHz			3 dBm	0 dBm	0 dBm	0 dBm	0 dBm	
20 to 40 GHz				-5 dBm	-8 dBm	-5 dBm	-8 dBm	
40 to 50 GHz					-11 dBm	-15 dBm		
<b>Power level linearity<sup>2</sup></b>								<b>Options as indicated</b>
Test reference is at the nominal power level								
300 kHz to 1 MHz	±4.5 dB	±4.5 dB						±2.0 dB (Opt 020, 025, 120, 125)
1 to 10 MHz	±1.0 dB	±1.0 dB						
10 to 45 MHz	±2.0 dB	±2.0 dB						±0.35 dB (Opt 220, 225) ±0.40 dB (Opt 420, 425, 520, 525)
45 MHz to 1 GHz	±2.0 dB	±2.0 dB	±1.0 dB	±1.0 dB	±1.0 dB	±1.0 dB	±1.0 dB	
1 to 12.5 GHz	±1.5 dB	±1.5 dB	±1.0 dB	±1.0 dB	±1.0 dB	±1.0 dB	±1.0 dB	
12.5 to 13.5 GHz	±1.5 dB	±1.5 dB	±1.0 dB	±1.0 dB	±1.0 dB	±1.0 dB	±1.0 dB	
13.5 to 20 GHz			±1.0 dB	±1.0 dB	±1.0 dB	±1.0 dB	±1.0 dB	
20 to 40 GHz				±1.0 dB	±1.0 dB	±1.0 dB	±1.0 dB	
40 to 50 GHz					±1.0 dB	±1.0 dB		

1. Performance specified on Port 1 only. Port 2 performance is a characteristic.  
 2. Power level linearity specified on Port 1 only. Port 2 performance is typical.  
 Test reference is at the nominal power level.

Table 10. Test port output<sup>1</sup> (Continued)

Description	Specifications							Typicals
	Option 020, 120	Option 025, 125	Option 220, 225	Option 420	Option 425	Option 520	Option 525	Option 220, 225
<b>Power sweep range (ALC)<sup>2</sup></b>								
300 kHz to 10 MHz	37 dB	36 dB						
10 to 45 MHz	37 dB	36 dB						25 dB
45 MHz to 6 GHz	37 dB	36 dB	25 dB	25 dB	25 dB	25 dB	25 dB	
6 to 9 GHz	35 dB	35 dB	25 dB	25 dB	25 dB	25 dB	25 dB	
9 to 12.5 GHz	31 dB	31 dB	25 dB	25 dB	25 dB	25 dB	25 dB	
12.5 to 13.5 GHz	29 dB	28 dB	23 dB	25 dB	25 dB	25 dB	25 dB	
13.5 to 20 GHz			23 dB	25 dB	25 dB	25 dB	25 dB	
20 to 40 GHz				20 dB	17 dB	20 dB	17 dB	
40 to 50 GHz						14 dB	10 dB	
<b>Power resolution</b>								<b>Options as indicated</b>
								0.01 dB (all options)

Description	Specification	Typicals					
		Option 020, 120	Option 025, 125	Option 220	Option 225	Option 420, 520	Option 425, 525
<b>Power range</b>							
300 kHz to 10 MHz		-30 to +10 dBm	-90 to +9 dBm				
10 to 45 MHz		-30 to +10 dBm	-90 to +9 dBm	-27 to +12 dBm	-87 to +12 dBm	-27 to +9 dBm	-87 to +8 dBm
45 MHz to 6 GHz		-30 to +10 dBm	-90 to +9 dBm	-27 to +12 dBm	-87 to +12 dBm	-27 to +8 dBm	-87 to +8 dBm
6 to 9 GHz		-30 to +8 dBm	-90 to +8 dBm	-27 to +12 dBm	-87 to +12 dBm	-27 to +8 dBm	-87 to +8 dBm
9 to 12.5 GHz		-30 to +4 dBm	-90 to +4 dBm	-27 to +12 dBm	-87 to +12 dBm	-27 to +8 dBm	-87 to +8 dBm
12.5 to 13.5 GHz		-30 to +2 dBm	-90 to +1 dBm	-27 to +7 dBm	-87 to +7 dBm	-27 to +5 dBm	-87 to +4 dBm
13.5 to 20 GHz				-27 to +7 dBm	-87 to +7 dBm	-27 to +5 dBm	-87 to +4 dBm
20 to 40 GHz						-27 to +1 dBm	-87 to -2 dBm
40 to 50 GHz						-27 to -5 dBm	-87 to -9 dBm
<b>Power settings</b>							
Minimum power setting		-33 dBm	-93 dBm	-30 dBm	-90 dBm	-30 dBm	-90 dBm
Maximum power setting		+20 dBm	+20 dBm	+20 dBm	+20 dBm	+20 dBm	+20 dBm

Description	Specification	Typicals					
		Option 020, 025, 120, 125			Option 220, 225, 420, 425, 520, 525		
<b>Phase noise (Nominal power at test port)</b>							
		<b>10 kHz Offset</b>	<b>100 kHz Offset</b>	<b>1 MHz Offset</b>	<b>10 kHz Offset</b>	<b>100 kHz Offset</b>	<b>1 MHz Offset</b>
300 kHz to 10 MHz		-86 dBc/Hz	-86 dBc/Hz	-95 dBc/Hz			
10 MHz to 1.5 GHz		-86 dBc/Hz	-91 dBc/Hz	-95 dBc/Hz	-77 dBc/Hz	-77 dBc/Hz	-89 dBc/Hz
1.5 to 3.125 GHz		-83 dBc/Hz	-91 dBc/Hz	-95 dBc/Hz	-83 dBc/Hz	-91 dBc/Hz	-95 dBc/Hz
3.125 to 6.25 GHz		-77 dBc/Hz	-85 dBc/Hz	-89 dBc/Hz	-77 dBc/Hz	-85 dBc/Hz	-89 dBc/Hz
6.25 to 12.5 GHz		-71 dBc/Hz	-79 dBc/Hz	-83 dBc/Hz	-71 dBc/Hz	-79 dBc/Hz	-83 dBc/Hz
12.5 to 13.5 GHz		-65 dBc/Hz	-73 dBc/Hz	-77 dBc/Hz	-65 dBc/Hz	-73 dBc/Hz	-77 dBc/Hz
13.5 to 20 GHz					-65 dBc/Hz	-73 dBc/Hz	-77 dBc/Hz
20 to 40 GHz					-59 dBc/Hz	-67 dBc/Hz	-71 dBc/Hz
40 to 50 GHz					-59 dBc/Hz	-67 dBc/Hz	-71 dBc/Hz

<b>Non-harmonic spurious (at nominal output power)</b>							
300 kHz to 10 MHz							
10 MHz to 13.5 GHz				-50 dBc for offset frequency > 1 kHz			
13.5 to 20 GHz							
20 to 40 GHz				-30 dBc for offset frequency > 1 kHz			
40 to 50 GHz							

Description	Specification	Typicals			
		Option 020, 025, 120, 125	Option 220, 225	Option 420, 425	Option 520, 525
<b>Harmonics (2nd or 3rd) at maximum output power</b>					
300 kHz to 10 MHz		-17 dBc			
10 to 500 MHz		-17 dBc	-22 dBc	-15 dBc	-15 dBc
500 MHz to 1 GHz		-17 dBc	-22 dBc	-15 dBc	-15 dBc
1 to 13.5 GHz		-20 dBc	-22 dBc	-20 dBc	-20 dBc
13.5 to 20 GHz			-22 dBc	-20 dBc	-20 dBc
20 to 40 GHz				-22 dBc	-22 dBc
40 to 50 GHz					-22 dBc

1. Performance specified on Port 1 only. Port 2 performance is a characteristic.

2. ALC range starts at maximum leveled power and decreases in power level indicated by the dB amount specified here.

Table 11: Test port input

Description	Specifications				Typicals			
	Option 020, 025, 120, 125	Option 220, 225	Option 420, 425	Option 520, 525	Option 020, 025, 120, 125	Option 220, 225	Option 420, 425	Option 520, 525
<b>Test port noise floor<sup>1</sup> 10 Hz IF bandwidth<sup>2</sup></b>								
300 kHz to 3 MHz <sup>3</sup>	< -83 dBm				< -94 dBm			
3 to 10 MHz	< -103 dBm				< -110 dBm			
10 to 45 MHz	< -112 dBm				< -116 dBm	< -89 dBm	< -80 dBm	< -80 dBm
45 to 70 MHz	< -112 dBm	< -96 dBm	< -90 dBm	< -90 dBm	< -116 dBm			
70 to 500 MHz	< -112 dBm	< -100 dBm	< -90 dBm	< -90 dBm	< -116 dBm			
500 MHz to 2 GHz	< -112 dBm	< -105 dBm	< -110 dBm	< -110 dBm	< -120 dBm			
2 to 4 GHz	< -112 dBm	< -105 dBm	< -110 dBm	< -110 dBm	< -120 dBm			
4 to 8 GHz	< -112 dBm	< -105 dBm	< -110 dBm	< -110 dBm	< -119 dBm			
8 to 10.5 GHz	< -112 dBm	< -105 dBm	< -100 dBm	< -100 dBm	< -119 dBm			
10.5 to 13.5 GHz	< -107 dBm	< -105 dBm	< -100 dBm	< -100 dBm	< -114 dBm			
13.5 to 20 GHz	< -105 dBm		< -100 dBm	< -100 dBm				
20 to 31.25 GHz					< -100 dBm < -100 dBm			
31.25 to 40 GHz					< -95 dBm < -95 dBm			
40 to 50 GHz					< -90 dBm			
<b>Test port noise floor<sup>1</sup> 1 KHz IF bandwidth</b>								
300 kHz to 3 MHz <sup>3</sup>	< -73 dBm				< -83 dBm			
3 to 10 MHz	< -83 dBm				< -90 dBm			
10 to 45 MHz	< -92 dBm				< -96 dBm	< -69 dBm	< -60 dBm	< -60 dBm
45 to 70 MHz	< -92 dBm	< -76 dBm	< -70 dBm	< -70 dBm	< -96 dBm			
70 to 500 MHz	< -92 dBm	< -80 dBm	< -70 dBm	< -70 dBm	< -96 dBm			
500 MHz to 2 GHz	< -92 dBm	< -85 dBm	< -90 dBm	< -90 dBm	< -100 dBm			
2 to 4 GHz	< -92 dBm	< -85 dBm	< -90 dBm	< -90 dBm	< -100 dBm			
4 to 8 GHz	< -92 dBm	< -85 dBm	< -90 dBm	< -90 dBm	< -99 dBm			
8 to 10.5 GHz	< -92 dBm	< -85 dBm	< -80 dBm	< -80 dBm	< -99 dBm			
10.5 to 13.5 GHz	< -87 dBm	< -85 dBm	< -80 dBm	< -80 dBm	< -94 dBm			
13.5 to 20 GHz	< -85 dBm		< -80 dBm	< -80 dBm				
20 to 31.25 GHz					< -80 dBm < -80 dBm			
31.25 to 40 GHz					< -75 dBm < -75 dBm			
40 to 50 GHz					< -70 dBm			
Description	Specifications				Typicals			
	Option 020, 125	Option 225	Option 425	Option 525	Option 020, 125	Option 225	Option 425	Option 525
<b>Direct receiver access input noise floor<sup>1</sup> 10 Hz IF bandwidth<sup>2</sup></b>								
300 kHz to 3 MHz <sup>3</sup>	< -99 dBm							
3 to 10 MHz	< -119 dBm							
10 to 45 MHz	< -128 dBm				< -120 dBm < -126 dBm < -126 dBm			
45 to 70 MHz	< -128 dBm	< -108 dBm	< -111 dBm	< -111 dBm				
70 to 500 MHz	< -128 dBm	< -112 dBm	< -111 dBm	< -111 dBm				
500 MHz to 2 GHz	< -128 dBm	< -117 dBm	< -122 dBm	< -122 dBm				
2 to 8 GHz	< -128 dBm	< -117 dBm	< -122 dBm	< -122 dBm				
8 to 10.5 GHz	< -128 dBm	< -117 dBm	< -112 dBm	< -112 dBm				
10.5 to 13.5 GHz	< -128 dBm	< -117 dBm	< -112 dBm	< -112 dBm				
13.5 to 20 GHz	< -117 dBm		< -112 dBm	< -112 dBm				
20 to 31.25 GHz					< -111 dBm < -111 dBm			
31.25 to 40 GHz					< -106 dBm < -106 dBm			
40 to 50 GHz					< -98 dBm			
<b>Direct receiver access input noise floor<sup>1</sup> 1 KHz IF bandwidth</b>								
300 kHz to 3 MHz <sup>3</sup>	< -89 dBm							
3 to 10 MHz	< -99 dBm							
10 to 45 MHz	< -108 dBm				< -100 dBm < -106 dBm < -106 dBm			
45 to 70 MHz	< -108 dBm	< -88 dBm	< -91 dBm	< -91 dBm				
70 to 500 MHz	< -108 dBm	< -92 dBm	< -91 dBm	< -91 dBm				
500 MHz to 2 GHz	< -108 dBm	< -97 dBm	< -102 dBm	< -102 dBm				
2 to 8 GHz	< -108 dBm	< -97 dBm	< -102 dBm	< -102 dBm				
8 to 10.5 GHz	< -108 dBm	< -97 dBm	< -92 dBm	< -92 dBm				
10.5 to 13.5 GHz	< -108 dBm	< -97 dBm	< -92 dBm	< -92 dBm				
13.5 to 20 GHz	< -97 dBm		< -92 dBm	< -92 dBm				
20 to 31.25 GHz					< -91 dBm < -91 dBm			
31.25 to 40 GHz					< -86 dBm < -86 dBm			
40 to 50 GHz					< -78 dBm			

1. Total average (rms) noise power calculated as the mean value of a linear magnitude trace expressed in dBm.

2. 10 Hz IFBW test port noise floor performance is mathematically derived from the 1 kHz IFBW noise floor performance. The performance could be limited by crosstalk below 3 MHz at certain frequencies. The measurement is defined as a single receiver measurement with loads on the ports at a given CW frequency with power set to the minimum plus 5 dB.

3. Value and/or frequency changed July 2006.

Table 11: Test port input (Continued)

Description	Specifications						Typicals	
	Option 220, 225		Option 420, 520		Option 425, 525		Option 220, 225	
Compression level	Power	Compression	Power	Compression	Power	Compression	Power	Compression
10 to 45 MHz <sup>2</sup>							+5 dBm	0.10 dB
45 to 500 MHz	+5 dBm	0.10 dB	+5 dBm	0.40 dB	+5 dBm	0.40 dB		
500 MHz to 2 GHz	+5 dBm	0.15 dB	+5 dBm	0.77 dB	+5 dBm	0.67 dB		
2 to 8 GHz	+5 dBm	0.21 dB	+5 dBm	0.75 dB	+5 dBm	0.55 dB		
8 to 12.5 GHz	+5 dBm	0.21 dB	+5 dBm	0.56 dB	+5 dBm	0.51 dB		
12.5 to 20 GHz	+3 dBm	0.20 dB	+5 dBm	0.79 dB	+5 dBm	0.69 dB		
20 to 31.25 GHz			0 dBm	0.60 dB	0 dBm	0.50 dB		
31.25 to 40 GHz			-3 dBm	0.55 dB	-3 dBm	0.60 dB		
40 to 50 GHz			-3 dBm	0.66 dB	-3 dBm	0.71 dB		

Description	Specifications		Typicals
	Option 020, 120, 025, 125		
Compression level	Power	Compression	
300 kHz to 10 MHz	+8 dBm	1.0 dB	0.1 dB at +5 dBm
10 to 50 MHz	+8 dBm	0.35 dB	
50 MHz to 1 GHz	+8 dBm	0.35 dB	
1 to 6 GHz	+8 dBm	0.25 dB	
6 to 8 GHz	+8 dBm	0.25 dB	
8 to 12.5 GHz	+8 dBm	0.30 dB	
12.5 to 13.5 GHz	+8 dBm	0.40 dB	

Description	Specifications		Typicals
	Option 020, 120, 025, 125		
Compression level - 0.1 dB	Power	Compression	
300 kHz to 10 MHz	+5 dBm	0.1 dB	
10 MHz to 1 GHz	+9 dBm	0.1 dB	
1 to 12.5 GHz	+10 dBm	0.1 dB	
12.5 to 13.5 GHz	+9 dBm	0.1 dB	

Description	Specifications			Typicals			
	Option 220, 225	Option 420, 425	Option 520, 525	Option 220	Option 225	Option 420, 425	Option 520, 525
<b>Test port compression - 0.1 dB</b>							
300 kHz to 10 MHz							
10 to 45 MHz <sup>2</sup>				+10 dBm	negligible	negligible	negligible
45 to 500 MHz				+10 dBm	+10 dBm	0.0 dBm	+1.0 dBm
500 MHz to 2 GHz				+9 dBm	+9 dBm	0.0 dBm	+1.0 dBm
2 to 12.5 GHz				+6 dBm	+6 dBm	0.0 dBm	+1.5 dBm
12.5 to 13.5 GHz				+6 dBm	+6 dBm	-1.0 dBm	0.0 dBm
13.5 to 20 GHz				+6 dBm	+6 dBm	-1.0 dBm	0.0 dBm
20 to 31.25 GHz						-5.5 dBm	-3.0 dBm
31.25 to 40 GHz						-8.5 dBm	-7.5 dBm
40 to 50 GHz							-10.0 dBm

**Trace noise magnitude<sup>3</sup>**

**1 kHz IF bandwidth**, ratioed measurement, nominal power at test port.

300 kHz to 10 MHz							
10 to 45 MHz				0.004 dB rms	0.015 dB rms	0.015 dB rms	
45 to 500 MHz	0.004 dB rms	0.010 dB rms	0.010 dB rms				
500 MHz to 2 GHz	0.004 dB rms	0.006 dB rms	0.006 dB rms				
2 to 10.5 GHz	0.004 dB rms	0.006 dB rms	0.006 dB rms				
10.5 to 13.5 GHz	0.006 dB rms	0.010 dB rms	0.010 dB rms				
13.5 to 20 GHz	0.006 dB rms	0.010 dB rms	0.010 dB rms				
20 to 31.25 GHz		0.010 dB rms	0.010 dB rms				
31.25 to 40 GHz		0.020 dB rms	0.020 dB rms				
40 to 50 GHz			0.020 dB rms				

1. Total average (rms) noise power calculated as the mean value of a linear magnitude trace expressed in dBm.
2. For Options 225, 420, 425, 520, and 525 coupler roll-off will reduce compression to a negligible level below 45 MHz.
3. 1 kHz IF BW, ratioed measurement, nominal power at the test port.
4. Stability is defined as a ratio measurement made at the test port.

Table 11: Test port input (Continued)

Description	Specifications		Typicals
	Option 020, 120, 025, 125		Option 020, 120, 025, 125
<b>Trace noise magnitude<sup>3</sup></b> (continued)			
<b>100 kHz IF bandwidth</b> , ratioed measurement, nominal power at test port.			
300 kHz to 10 MHz	12 mdB		
10 MHz to 6 GHz	4 mdB		
6 to 10.5 GHz	4 mdB		
10.5 to 13.5 GHz	8 mdB		
<b>600 kHz IF bandwidth</b> , ratioed measurement, nominal power at test port.			
300 kHz to 10 MHz			20 mdB
10 MHz to 6 GHz			8 mdB
6 to 10.5 GHz			8 mdB
10.5 to 13.5 GHz			10 mdB

Description	Specifications			Typicals		
	Option 220, 225	Option 420, 425	Option 520, 525	Option 220, 225	Option 420, 425	Option 520, 525
<b>Trace noise phase<sup>3</sup></b>						
<b>1 kHz IF bandwidth</b> , ratioed measurement, nominal power at test port.						
300 kHz to 10 MHz						
10 to 45 MHz				0.025° rms	0.100° rms	0.100° rms
45 to 500 MHz	0.060° rms	0.100° rms	0.100° rms			
500 MHz to 2 GHz	0.060° rms	0.060° rms	0.060° rms			
2 to 10.5 GHz	0.060° rms	0.060° rms	0.060° rms			
10.5 to 13.5 GHz	0.060° rms	0.100° rms	0.100° rms			
13.5 to 20 GHz	0.060° rms	0.100° rms	0.100° rms			
20 to 31.25 GHz		0.100° rms	0.100° rms			
31.25 to 40 GHz		0.200° rms	0.200° rms			
40 to 50 GHz			0.200° rms			

Description	Specifications		Typicals
	Option 020, 120, 025, 125		Option 020, 120, 025, 125
<b>Trace noise phase<sup>3</sup></b>			
<b>100 kHz IF bandwidth</b> , ratioed measurement, nominal power at test port.			
300 kHz to 10 MHz	80 mdeg		
10 MHz to 6 GHz	30 mdeg		
6 to 10.5 GHz	30 mdeg		
10.5 to 13.5 GHz	60 mdeg		
<b>600 kHz IF bandwidth</b> , ratioed measurement, nominal power at test port.			
300 kHz to 10 MHz			100 mdeg
10 MHz to 6 GHz			60 mdeg
6 to 10.5 GHz			60 mdeg
10.5 to 13.5 GHz			80 mdeg

Description	Specifications		Typicals
	Option 020, 025, 120, 125, 220, 225, 420, 425, 520, 525		Option 020, 025, 120, 125, 220, 225, 420, 425, 520, 525
<b>Reference level magnitude</b>			
Range	±200 dB		
Resolution	0.001 dB		
<b>Reference level phase</b>			
Range	±500°		
Resolution	0.01°		

1. Total average (rms) noise power calculated as the mean value of a linear magnitude trace expressed in dBm.
2. For Options 225, 420, 425, 520, and 525 coupler roll-off will reduce compression to a negligible level below 45 MHz.
3. 1 kHz IF BW, ratioed measurement, nominal power at the test port.
4. Stability is defined as a ratio measurement made at the test port.

Table 11: Test port input (Continued)

Description	Specifications			Typicals		
	Option 020, 025, 120, 125	Option 220, 225	Option 420, 425, 520, 525	Option 020, 025, 120, 125	Option 220, 225	Option 420, 425, 520, 525
<b>Stability magnitude<sup>4</sup></b>						
300 kHz to 10 MHz				±0.015 dB/°C		
10 to 45 MHz				±0.010 dB/°C	±0.015 dB/°C	±0.015 dB/°C
45 to 500 MHz				±0.010 dB/°C	±0.010 dB/°C	±0.010 dB/°C
500 MHz to 2 GHz				±0.010 dB/°C	±0.010 dB/°C	±0.010 dB/°C
2 to 4 GHz				±0.015 dB/°C	±0.020 dB/°C	±0.010 dB/°C
4 to 8 GHz				±0.020 dB/°C	±0.020 dB/°C	±0.010 dB/°C
8 to 13.5 GHz				±0.020 dB/°C	±0.030 dB/°C	±0.015 dB/°C
13.5 to 20 GHz					±0.030 dB/°C	±0.015 dB/°C
20 to 40 GHz						±0.040 dB/°C
40 to 50 GHz						±0.060 dB/°C
<b>Stability phase<sup>4</sup></b>						
300 kHz to 10 MHz				±0.30°/°C		
10 to 45 MHz				±0.025°/°C	±0.25°/°C	±0.25°/°C
45 to 500 MHz				±0.035°/°C	±0.20°/°C	±0.22°/°C
500 MHz to 2 GHz				±0.050°/°C	±0.15°/°C	±0.22°/°C
2 to 4 GHz				±0.10°/°C	±0.15°/°C	±0.10°/°C
4 to 8 GHz				±0.15°/°C	±0.15°/°C	±0.10°/°C
8 to 13.5 GHz				±0.30°/°C	±0.45°/°C	±0.15°/°C
13.5 to 20 GHz					±0.45°/°C	±0.15°/°C
20 to 40 GHz						±0.40°/°C
40 to 50 GHz						±0.40°/°C

Description	Specifications		Typicals			
	Option 020, 120	Option 220	Option 420, 520	Option 025, 125	Option 225, 425, 525	
<b>Damage input level</b>						
Test port 1 and 2	+27 dBm or ±16 VDC	+30 dBm or ±25 VDC	+30 dBm or ±40 VDC	+27 dBm or ±16 VDC	+27 dBm or ±7 VDC	
R1, R2 in				+15 dBm or ±16 VDC	+15 dBm or ±7 VDC	
A, B in				+15 dBm or ±16 VDC	+15 dBm or ±7 VDC	
Coupler thru				+27 dBm or ±16 VDC	+30 dBm or ±40 VDC	
Coupler arm				+15 dBm or ±0 VDC	+30 dBm or ±7 VDC	
Source out (reference)				+20 dBm or ±16 VDC	+20 dBm or ±7 VDC	
Source out (test ports)				+27 dBm or ±16 VDC	+30 dBm or ±7 VDC	

1. Total average (rms) noise power calculated as the mean value of a linear magnitude trace expressed in dBm.
2. For Options 225, 420, 425, 520, and 525 coupler roll-off will reduce compression to a negligible level below 45 MHz.
3. 1 kHz IF BW, ratioed measurement, nominal power at the test port.
4. Stability is defined as a ratio measurement made at the test port.



## Dynamic Accuracy

Note: Dynamic accuracy uncertainty curves are available within the PNA-L network analyzer's internal Help system. The Help system is also available online at [www.agilent.com](http://www.agilent.com). Navigate to the home page for your PNA model, then click on manuals & guides. Please download our free uncertainty calculator from [www.agilent.com/find/na\\_calculator](http://www.agilent.com/find/na_calculator) to generate the curves for your calibration kit and PNA setup.

Table 12. Test port input (group delay)<sup>1</sup>

Description	Specification	Supplemental information (typ.)
Aperture (selectable)		(frequency span)/(number of points -1)
Maximum aperture		20% of frequency span
Range		0.5 x (1/minimum aperture)
Maximum delay		Limited to measuring no more than 180° of phase change within the minimum aperture
Accuracy		See graph below. Char.

The following graph shows characteristic group delay accuracy with full 2-port calibration and a 10 Hz IF bandwidth. Insertion loss is assumed to be < 2 dB and electrical length to be ten meters.

### Group delay (typical)

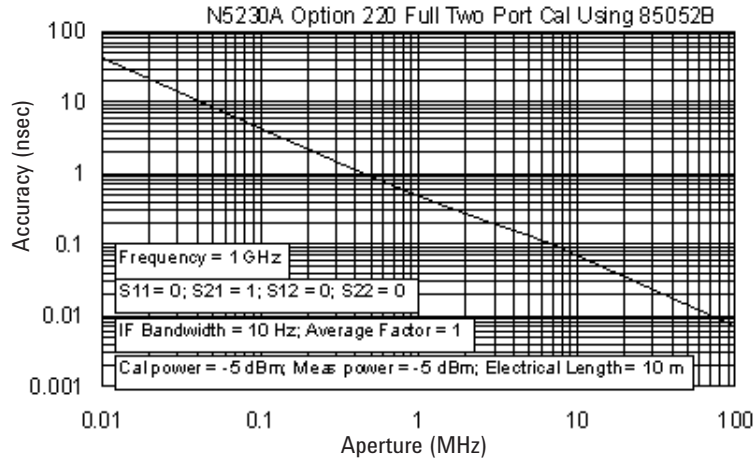

In general, the following formula can be used to determine the accuracy, in seconds, of specific group delay measurement:

$$\pm \text{Phase Accuracy (deg)} / [360^\circ \text{ Aperture (Hz)}]$$

Depending on the aperture and device length, the phase accuracy used is either incremental phase accuracy or worst case phase accuracy.

1. Group delay is computed by measuring the phase change within a specified frequency step (determined by the frequency span and the number of points per sweep).

## General Information

**Table 13. Miscellaneous information**

Description	Supplemental information
<b>System IF bandwidth range</b>	Option 020, 025, 120, 125 1 Hz to 600 kHz, nominal Option 220, 225, 420, 425, 520, 525 1 Hz to 250 kHz, nominal
<b>CPU</b>	Intel® 1.1 GHz Pentium® M with 1 GByte RAM

**Table 14. Front panel information**

Description	Supplemental information
<b>RF connectors</b>	
<b>N5230A</b>	
Type	Option 020, 025, 120, 125, 220 or 225: 3.5 mm (male), 50 ohm, (nominal) Option 420, 425, 520, or 525: 2.4 mm (male), 50 ohm, (nominal)
Center pin recession	0.002 in. (characteristic)
<b>Display</b>	
Size	21.3 cm (8.4 in) diagonal color active matrix LCD; 640 (horizontal) X 480 (vertical) resolution
Refresh rate	Vertical 59.83 Hz; Horizontal 31.41 kHz
Pixels	A display is considered faulty if: <ul style="list-style-type: none"> <li>• A complete row or column of "stuck" or "dark" pixels.</li> <li>• More than six "stuck on" pixels (but not more than three green) or more than 0.002% of the total pixels are within the LCD specifications.</li> <li>• More than twelve "dark" pixels (but no more than seven of the same color) or more than 0.004% of the total pixels are within the LCD specifications.</li> <li>• Two or more consecutive "stuck on" pixels or three or more consecutive "dark" pixel (but no more than one set of two consecutive dark pixels) "Stuck on" of "dark" pixels less than 6.5 mm apart (excluding consecutive pixels)</li> </ul>
Display range	The PNA display must remain in the 16-bit color setting in order to comply with international emissions regulations
Magnitude	±500 dB (at 20 dB/div), max
Phase	±500°, max
Polar	10 pUnits, min 1000 Units, max
<b>Display resolution</b>	
Magnitude	0.001 dB/div, min
Phase	0.01°/div, min
<b>Marker resolution</b>	
Magnitude	0.001 dB, min
Phase	0.01°, min
Polar	0.01 mUnit, min; 0.01°, min

1. Any PNA Service Guide contains instructions for running the analyzer's built-in Display Test". You can view a PDF file of a Service Guide on the Web at [www.agilent.com/find/pna](http://www.agilent.com/find/pna). After opening the PDF file, look in the left-side column and then click on the "Index" bookmark. From the index, click on "Display Test".

**Table 15. Rear panel information**

<b>Description</b>	<b>Supplemental information</b>
<b>Trigger inputs/outputs</b>	<b>BNC (f), TTL/CMOS compatible</b>
<b>10 MHz Reference in</b>	
Connector	BNC, female
Input frequency	10 MHz $\pm$ 10 ppm, typical
Input level	-15 to +20 dBm, typical
Input impedance	200 $\Omega$ , nom.
<b>10 MHz Reference out</b>	
Connector	BNC, female
Output frequency	10 MHz $\pm$ 1 ppm, typical
Signal type	Sine Wave, typical
Output level	+10 dBm $\pm$ 4 dB into 50 W, typical
Output impedance	50 $\Omega$ , nominal
Harmonics	< -40 dBc, typical
<b>VGA Video output</b>	
Connector	15-pin mini D-Sub; Drives VGA compatible monitors
<b>Test set IO</b>	
	25-pin D-Sub connector, available for external test set control
<b>Aux IO</b>	
	25-pin D-Sub connector, male, analog and digital I/O
<b>Handler IO</b>	
	36-pin parallel I/O port; all input/output signals are default set to negative logic; can be reset to positive logic via GPIB command
<b>GPIB</b>	
	Two ports: dedicated Controller and dedicated Talker/Listener. 24-pin D-sub (Type D-24), female; compatible with IEEE-488.
<b>USB Port</b>	
	1 port on front panel and 4 ports on rear panel.
<b>LAN</b>	
	10/100BaseT Ethernet, 8-pin configuration; auto selects between the two data rates
<b>Line power (single phase)</b>	
Frequency, voltage	50/60 Hz/400 Hz for 100 to 120V, 50/60 Hz for 220 to 240 V, (power supply is auto switching)
Maximum	350 Watts

**Note:** Option H08 and Option H11 specifications are not provided in this N5230A specifications document.

**Table 16. Analyzer environment and dimensions**

<b>Description</b>	<b>Supplemental information</b>
<b>General environmental</b>	
EMC	Complies with European EMC directive 89/336/EEC, amended by 93/68/EEC <ul style="list-style-type: none"> <li>• IEC/EN 61326</li> <li>• CISPR Pub 11 Group 1, class A</li> <li>• AS/NZS CISPR II:2002</li> <li>• ICES/NMB-001</li> </ul>
Safety	Complies with European Low Voltage Directive 73/23/EEC, amended by 93/68/EEC <ul style="list-style-type: none"> <li>• IEC/EN 61010-1:2001</li> <li>• Canada: CSA C22.2 No. 61010-1:2001</li> <li>• USA: UL 61010-1</li> </ul>
<b>Operating environment</b>	
Temperature	0 to +40 °C  Instrument powers up and displays no error messages within this temperature range (except for "source unlevelled" error message that may occur at temperatures outside the specified performance temperature range of 25 ± 5 °C).
Error-corrected temperature range	23 °C ± 3 °C with less than 1 °C deviation from calibration temp.
Relative humidity	Type-tested 0 to 95% at 40 °C, non-condensing
Altitude	0 to 4600 m (15,000 ft.)
<b>Non-operating storage environment</b>	
Temperature	-40 to +70 °C
<b>Cabinet dimensions</b>	
	<b>Height    Width    Depth</b>
Excluding front and rear panel hardware and feet	267 mm    426 mm    427 mm 10.5 in    16.75    16.8 in
As shipped - includes front panel connectors, rear panel bumpers, and feet.	280 mm    435 mm    470 mm 11 in    17.10 in    18.5 in
As shipped plus handles	280 mm    458 mm    501 mm 11 in    18 in    19.7 in
As shipped plus rack-mount flanges	280 mm    483 mm    470 mm 11 in    19 in    18.5 in
As shipped plus handles and rack-mount flanges	280 mm    483 mm    501 mm 11 in    19 in    19.7 in
<b>Weight</b>	
Net	
N5230A	24.9 kg (55 lb), nominal
Shipping	
N5230A	36.3 kg (80 lb), nominal

# N5230A

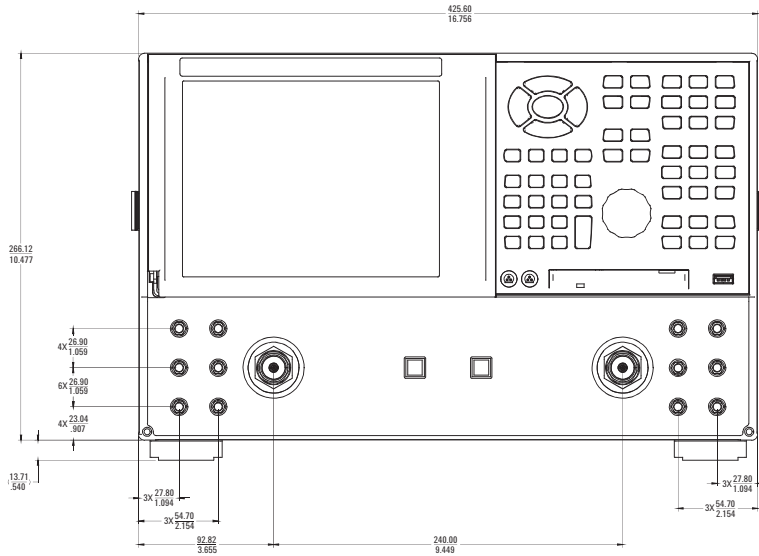

## Measurement Throughput Summary

Table 17. Typical cycle time<sup>1,2</sup> (ms) for measurement completion

	Number of Points				
	201	401	801	1601	16,001
<b>Start 8 GHz, stop 18 GHz, 30 kHz IF bandwidth</b>					
Uncorrected	97.5	102.7	103.8	108.2	683.9
2-Port cal	203.7	213.5	218.5	234.6	1504.3
<b>Start 10 MHz, stop 10 GHz, 30 kHz IF bandwidth</b>					
Uncorrected	112.6	120.6	124.8	138.2	738.4
2-Port cal	232.8	251.8	265.2	304.3	1623.4
<b>Start 10 MHz, stop 20 GHz, 30 kHz IF bandwidth</b>					
Uncorrected	146	199.3	210.9	217.2	753.9
2-Port cal	302.3	410.5	438.7	462.5	1660.5
<b>Start 8 GHz, stop 18 GHz, 50 kHz IF bandwidth</b>					
Uncorrected	79.1	81	81.7	86.6	482
2-Port cal	164.5	170.3	175.3	193.5	1104.7
<b>Start 10 MHz, stop 10 GHz, 50 kHz IF bandwidth</b>					
Uncorrected	96.8	101.7	108.8	122.2	524.6
2-Port cal	202.1	215.6	236.7	276.7	1198.8
<b>Start 10 MHz, stop 20 GHz, 50 kHz IF bandwidth</b>					
Uncorrected	141.6	163.9	170.7	179.7	546.5
2-Port cal	293.6	341	360	389.5	1248.8

1. Typical performance.
2. Includes sweep time, retrace time and band-crossing time. Analyzer display turned off with DISPLAY:ENABLE OFF. Add 21 ms for display on. Data for one trace (S11) measurement.

**Table 18. Cycle Time vs IF bandwidth<sup>1</sup> (Options 020, 025, 120, 125 only)**

Applies to the preset condition (201 points, correction off) except for the following changes:

- CF = 10 GHz
- Span = 100 MHz
- Display off (add 21 ms for display on)

Description		Typical performance
IF Bandwidth (Hz)	Cycle time (ms) <sup>2</sup>	Trace noise (dB rms)
600,000	7	0.0035
360,000	7	0.0026
280,000	7	0.0022
200,000	7	0.0021
150,000	7	0.0016
100,000	7	0.0012
70,000	7	0.0011
50,000	9	0.0009
30,000	11	0.0008
20,000	14	0.0006
15,000	17	0.0005
10,000	28	0.0004
7,000	37	0.0004
5,000	48	0.0003
3,000	72	0.0003
2,000	102	0.0002
1,500	130	0.0001
1,000	218	0.0001
700	294	0.0001
500	399	0.0001
300	636	0.0001
200	932	negligible
100	1,826	negligible
30	6,004	negligible
10	17,903	negligible
1	178,398	negligible

1. Typical performance.
2. Cycle time includes sweep and retrace time.

**Table 21. Cycle time vs number of points<sup>1</sup> (Options 220, 225, 420, 425, 520, 525 only)**

**Table 19. Cycle Time vs IF bandwidth<sup>1</sup> (Options 220, 225, 420, 425, 520, 525 only)**

Applies to the preset condition (201 points, correction off) except for the following changes:

- CF = 10 GHz
- Span = 100 MHz
- Display off (add 21 ms for display on)

<b>Description</b>		<b>Typical performance</b>
<b>IF Bandwidth (Hz)</b>	<b>Cycle time (ms)<sup>2</sup></b>	<b>Cycle time (ms) Option 080 enabled</b>
250,000	8	37
200,000	9	39
150,000	9	40
100,000	10	41
70,000	11	43
50,000	12	45
30,000	15	50
20,000	18	53
15,000	21	57
10,000	27	65
7,000	34	75
5,000	48	93
3,000	72	124
2,000	108	169
1,500	126	187
1,000	272	
700	357	
500	460	
300	697	
200	1003	
150	1307	
100	1917	
30	6173	
10	18214	
1	181699	

1. Typical performance.
2. Cycle time includes sweep and retrace time.

**Table 20. Cycle time vs number of points<sup>1</sup> (Options 020, 025, 120, 125 only)**

Applies to the preset condition (201 points, correction off) except for the following changes:

- CF = 10 GHz
- Span = 100 MHz
- Display off (add 21 ms for display on)

<b>Description</b>		<b>Typical performance</b>
<b>IF Bandwidth (Hz)</b>	<b>Number of points</b>	<b>Cycle time (ms)<sup>2</sup></b>
30,000	3	6
	11	7
	51	6
	101	7
	201	11
	401	18
	801	32
	1,601	59
	6,401	224
	16,001	556
300,000	3	6
	11	6
	51	6
	101	7
	201	7
	401	9
	801	13
	1,601	22
	6,401	75
	16,001	180
600,000	3	6
	11	6
	51	6
	101	6
	201	7
	401	8
	801	9
	1,601	12
	6,401	27
	16,001	59

1. Typical performance.
2. Cycle time includes sweep and retrace time.



Applies to the preset condition (correction off) except for the following changes:

- CF = 10 GHz
- Span = 100 MHz
- Display off (add 21 ms for display on)

<b>IF Bandwidth (Hz)</b>	<b>Number of points</b>	<b>Cycle time (ms)<sup>2</sup></b>
30,000	3	8
	11	8
	51	9
	101	11
	201	15
	401	23
	801	39
	1,601	71
	6,401	265
16,001	650	
50,000	3	7
	11	7
	51	8
	101	10
	201	13
	401	18
	801	29
	1,601	52
	6,401	184
16,001	448	
250,000	101	8
	201	9
	401	10
	801	14
	1,601	21
	6,401	61
16,001	147	

1. Typical performance.
2. Cycle time includes sweep and retrace time.

**Note:** Specifications for recall and sweep speed are not provided for the N5230A analyzers.

**Table 22. Data transfer time (ms)<sup>1</sup>**

	<b>Number of points</b>			
	201	401	1601	16,001
<b>SCPI over GPIB (program executed on external PC)</b>				
32-bit floating point	7	12	43	435
64-bit floating point	12	22	84	856
ASCII	64	124	489	5054
<b>SCPI (program executed in the analyzer)</b>				
32-bit floating point	1	2	3	30
64-bit floating point	2	2	4	40
ASCII	29	56	222	2220
<b>COM (program executed in the analyzer)</b>				
32-bit floating point	< 0.4	0.4	0.5	1.9
Variant type	0.7	1	3	32
<b>DCOM over LAN (program executed on external PC)</b>				
32-bit floating point	< 0.8	1	1.5	7.1
Variant type	1.8	2.7	8.5	80

1. Typical performance.

**Note:** Specifications for recall and sweep speed are not provided for the N5230A analyzers.

# Specifications: Front-Panel Jumpers

## Model N5230A Option 025, 125, 225, 425, or 525

**Note:** The N5230A Option 020, 120, 220, 420, or 520 (standard test set and standard power range) has no front-panel jumpers.

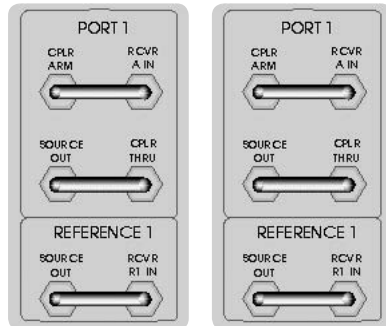

**Table 23: Measurement receiver inputs (rcvr A In, rcvr B In)  
0-1 dB Typical Compression**

Description	Specification	Typicals		
		Option 025, 125	Option 225	Options 425, 525
<b>Maximum input level</b>				
300 kHz to 10 MHz		-11 dBm		
10 to 45 MHz		-7 dBm	-2 dBm	-20 dBm
45 to 500 MHz		-7 dBm	-2 dBm	-19 dBm
500 MHz to 2 GHz		-6 dBm	-3 dBm	-14 dBm
2 to 12.5 GHz		-6 dBm	-6 dBm	-14 dBm
12.5 to 13.5 GHz		-7 dBm	-6 dBm	-15 dBm
13.5 to 20 GHz			-6 dBm	-15 dBm
20 to 31.25 GHz				-16 dBm
31.25 to 40 GHz				-21 dBm
40 to 45 GHz				-24 dBm
45 to 50 GHz				-22 dBm
<b>Damage level</b>				
N5230A		+15 dBm	+15 dBm	+15 dBm
<b>Maximum DC level</b>				
N5230A		±16 V	±7 V	±7 V

**Table 24: Reference receiver inputs (rcvr R1, rcvr R2)  
at maximum specified output power**

Description	Specification	Typicals		
		Option 025, 125	Option 225	Options 425, 525
<b>Maximum input level</b>				
300 kHz to 10 MHz		-15 dBm		
10 to 500 MHz		-13 dBm	-18 dBm	-28 dBm
500 to 2 MHz		-14 dBm	-18 dBm	-28 dBm
2 to 6 GHz		-14 dBm	-19 dBm	-28 dBm
6 to 8 GHz		-16 dBm	-19 dBm	-28 dBm
8 to 9 GHz		-16 dBm	-21 dBm	-27 dBm
9 to 10.5 GHz		-20 dBm	-21 dBm	-27 dBm
10.5 to 12.5 GHz		-22 dBm	-21 dBm	-27 dBm
12.5 to 13.5 GHz		-24 dBm	-23 dBm	-26 dBm
13.5 to 20 GHz			-23 dBm	-26 dBm
20 to 31.25 GHz				-33 dBm
31.25 to 40 GHz				-27 dBm
40 to 45 GHz				-29 dBm
45 to 50 GHz				-28 dBm
<b>Damage level</b>				
N5230A		+15 dBm	+15 dBm	+15 dBm
<b>Maximum DC level</b>				
N5230A		±16 V	±7 V	±7 V

**Table 25: Reference Outputs (reference 1 source out, reference 2 source out)  
at maximum specified output power**

Description	Specification	Typicals		
		Option 025, 125	Option 225	Options 425, 525
<b>Maximum output level</b>				
300 kHz to 10 MHz		-15 dBm		
10 to 500 MHz		-13 dBm	-18 dBm	-28 dBm
500 MHz to 2 GHz		-14 dBm	-18 dBm	-28 dBm
2 to 6 GHz		-14 dBm	-19 dBm	-28 dBm
6 to 8 GHz		-16 dBm	-19 dBm	-28 dBm
8 to 9 GHz		-16 dBm	-20 dBm	-27 dBm
9 to 10.5 GHz		-20 dBm	-20 dBm	-27 dBm
10.5 to 12.5 GHz		-22 dBm	-20 dBm	-27 dBm
12.5 to 13.5 GHz		-24 dBm	-23 dBm	-26 dBm
13.5 to 20 GHz			-23 dBm	-26 dBm
20 to 31.25 GHz				-32 dBm
31.25 to 40 GHz				-26 dBm
40 to 45 GHz				-29 dBm
45 to 50 GHz				-28 dBm
<b>Damage level</b>				
N5230A		+20 dBm	+20 dBm	+20 dBm
<b>Maximum DC level</b>				
N5230A		±16 V	±7 V	±7 V

**Table 26: Source outputs (port 1 source out, port 2 source out)  
at maximum specified output power**

Description	Specification	Typicals		
		Option 025, 125	Option 225	Options 425, 525
<b>Maximum output level</b>				
300 kHz to 10 MHz		+11 dBm		
10 to 500 MHz		+11 dBm	+6 dBm	+1 dBm
500 MHz to 6 GHz		+11 dBm	+7 dBm	+1 dBm
6 to 9 GHz		+10 dBm	+7 dBm	+1 dBm
9 to 12.5 GHz		+8 dBm	+7 dBm	+1 dBm
12.5 to 13.5 GHz		+5 dBm	+5 dBm	+3 dBm
13.5 to 20 GHz			+5 dBm	+3 dBm
20 to 31.25 GHz				-5 dBm
31.25 to 40 GHz				-4 dBm
40 to 45 GHz				-11 dBm
45 to 50 GHz				-11 dBm
<b>Damage level</b>				
N5230A		+27 dBm	+30 dBm	+30 dBm
<b>Maximum DC level</b>				
N5230A		±16 V	±7 V	±7 V

**Table 27: Coupler inputs (port 1 Cplr Thru, port 2 Cplr Thru)**

Description	Specification	Typicals		
		Option 025, 125	Option 225	Options 425, 525
<b>Insertion loss to test port</b>				
30 kHz to 10 MHz		2 dB		
10 to 500 MHz		2 dB	0.6 dB	0.6 dB
500 MHz to 2 GHz		3 dB	1.6 dB	0.8 dB
2 to 8 GHz		3 dB	1.8 dB	1.0 dB
8 to 9 GHz		3 dB	1.9 dB	1.0 dB
9 to 12.5 GHz		4 dB	1.9 dB	1.0 dB
12.5 to 13.5 GHz		4 dB	2.0 dB	2.0 dB
13.5 to 20 GHz			2.0 dB	2.0 dB
20 to 31.25 GHz				3.0 dB
31.25 to 50 GHz				4.0 dB
<b>Damage level</b>				
N5230A		+27 dBm	+30 dBm	+30 dBm
<b>Maximum DC level</b>				
N5230A		±16 V	±40 V	±40 V

**Table 28: Coupler outputs (port 1 Cplr Arm, port 2 Cplr Arm)**

Description	Specification	Typicals		
		Option 025, 125	Option 225	Options 425, 525
<b>Damage level</b>				
N5230A		+15 dBm	+30 dBm	+30 dBm
<b>Maximum DC level</b>				
N5230A		+0 Vdc	+7 Vdc	+7 Vdc

## Test Set Block Diagrams

**N5230A Option 020, 120, 220, 420, or 520**

**(standard test set and standard power range) network analyzer**

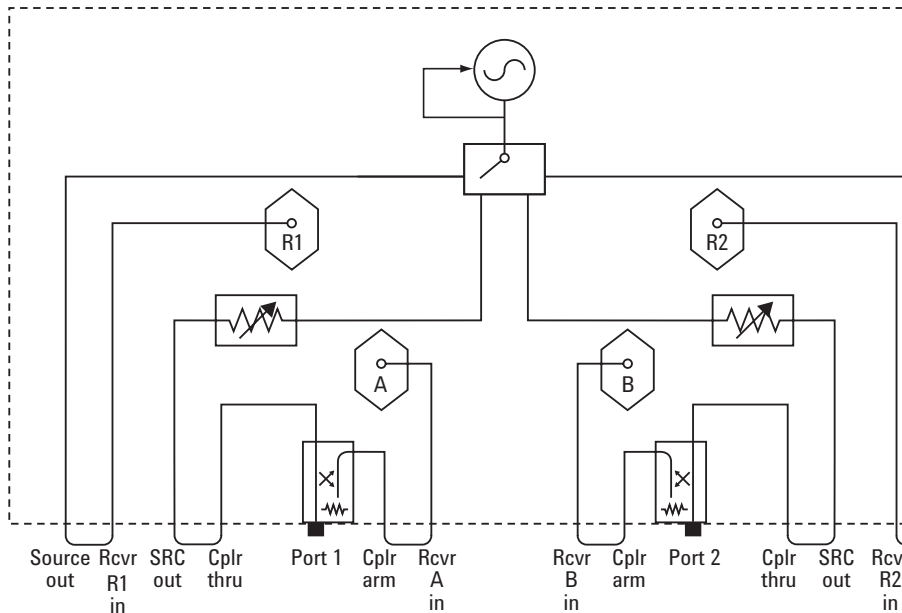

**N5230A Option 025, 125, 225, 425, or 525**

**(configurable test set and extended power range) network analyzer**

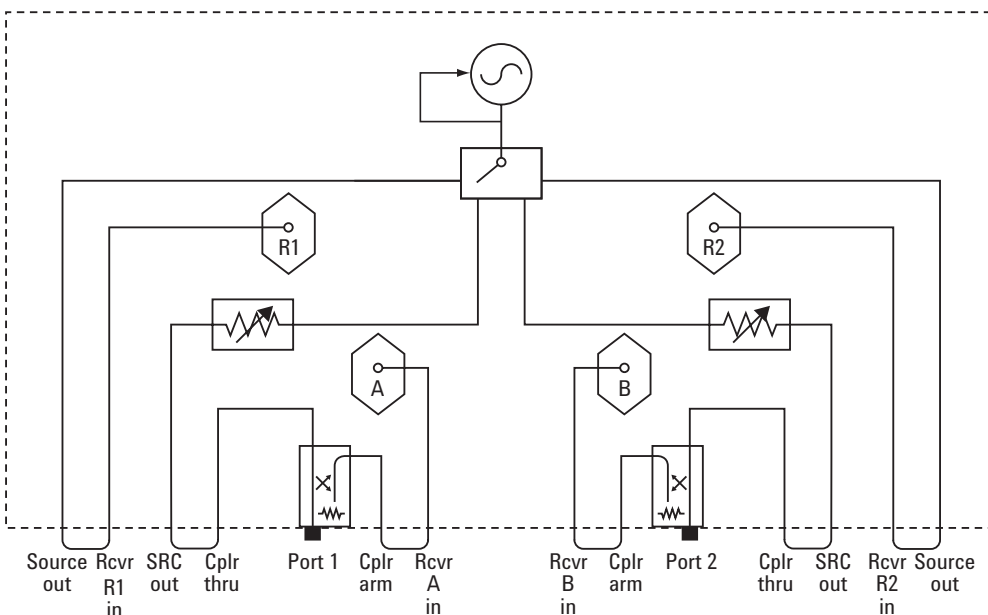

## Web Resources

Visit our Web sites for additional product information and literature.

PNA Microwave network analyzers:  
**[www.agilent.com/find/pna](http://www.agilent.com/find/pna)**

PNA-L network analyzers:  
**[www.agilent.com/find/pnal](http://www.agilent.com/find/pnal)**

Electronic calibration (ECal):  
**[www.agilent.com/find/ecal](http://www.agilent.com/find/ecal)**

Test and measurement solutions:  
**[www.agilent.com/find/accessories](http://www.agilent.com/find/accessories)**



### Agilent Email Updates

[www.agilent.com/find/emailupdates](http://www.agilent.com/find/emailupdates)

Get the latest information on the products and applications you select.



[www.axistandard.org](http://www.axistandard.org) AdvancedTCA<sup>®</sup> Extensions for Instrumentation and Test (AXIe) is

an open standard that extends the AdvancedTCA for general purpose and semiconductor test. Agilent is a founding member of the AXIe consortium.



[www.lxistandard.org](http://www.lxistandard.org)

LAN eXtensions for Instruments puts the power of Ethernet and the Web inside your test systems. Agilent is a founding member of the LXI consortium.



[www.pxisa.org](http://www.pxisa.org)

PCI eXtensions for Instrumentation (PXI) modular instrumentation delivers a rugged, PC-based high-performance measurement and automation system.

### Agilent Channel Partners

[www.agilent.com/find/channelpartners](http://www.agilent.com/find/channelpartners)

Get the best of both worlds: Agilent's measurement expertise and product breadth, combined with channel partner convenience.



Agilent Advantage Services is committed to your success throughout your equipment's lifetime. To keep you competitive, we continually invest in tools and processes that speed up calibration and repair and reduce your cost of ownership. You can also use Infoline Web Services to manage equipment and services more effectively. By sharing our measurement and service expertise, we help you create the products that change our world.

[www.agilent.com/find/advantageservices](http://www.agilent.com/find/advantageservices)



[www.agilent.com](http://www.agilent.com)  
[www.agilent.com/find/pnal](http://www.agilent.com/find/pnal)

For more information on Agilent Technologies' products, applications or services, please contact your local Agilent office. The complete list is available at:

[www.agilent.com/find/contactus](http://www.agilent.com/find/contactus)

#### Americas

Canada	(877) 894 4414
Brazil	(11) 4197 3500
Mexico	01800 5064 800
United States	(800) 829 4444

#### Asia Pacific

Australia	1 800 629 485
China	800 810 0189
Hong Kong	800 938 693
India	1 800 112 929
Japan	0120 (421) 345
Korea	080 769 0800
Malaysia	1 800 888 848
Singapore	1 800 375 8100
Taiwan	0800 047 866
Other AP Countries	(65) 375 8100

#### Europe & Middle East

Belgium	32 (0) 2 404 93 40
Denmark	45 70 13 15 15
Finland	358 (0) 10 855 2100
France	0825 010 700* *0.125 €/minute
Germany	49 (0) 7031 464 6333
Ireland	1890 924 204
Israel	972-3-9288-504/544
Italy	39 02 92 60 8484
Netherlands	31 (0) 20 547 2111
Spain	34 (91) 631 3300
Sweden	0200-88 22 55
United Kingdom	44 (0) 131 452 0200

For other unlisted countries:

[www.agilent.com/find/contactus](http://www.agilent.com/find/contactus)

Revised: June 8, 2011

Product specifications and descriptions in this document subject to change without notice.

© Agilent Technologies, Inc. 2008, 2009, 2011

Published in USA, October 12, 2011  
5989-0514EN

Intel<sup>®</sup> and Pentium<sup>®</sup> are US registered trademarks of Intel Corporation.

