

Agilent ENA 2 and 4 Port RF Network Analyzers

Data Sheet

- E5071C-230/430 – 9 kHz to 3 GHz
- E5071C-235/435 – 100 kHz to 3 GHz (with bias-tees)
- E5071C-280/480 – 9 kHz to 8.5 GHz
- E5071C-285/485 – 100 kHz to 8.5 GHz (with bias-tees)
- E5091A Multiport test set

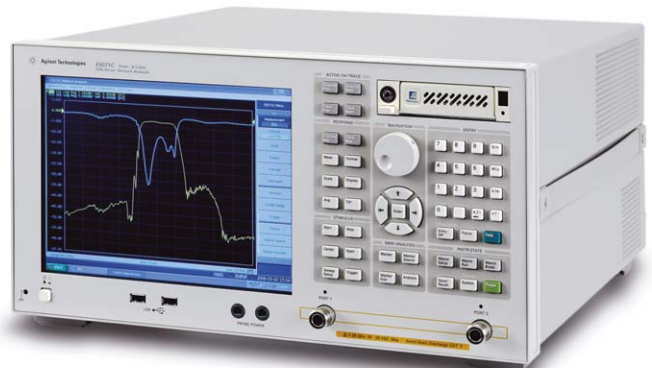

Agilent Technologies

Definitions

All specifications apply over a $23\text{ °C} \pm 5\text{ °C}$ range (unless otherwise stated) and 90 minutes after the instrument has been turned on.

Specification (spec.):

Warranted performance. Specifications include guardbands to account for the expected statistical performance distribution, measurement uncertainties, and changes in performance due to environmental conditions.

Supplemental information is intended to provide information that is helpful for using the instrument but that is not guaranteed by the product warranty.

Typical (typ.):

Describes performance that will be met by a minimum of 80% of all products. It is not guaranteed by the product warranty.

Supplemental performance data (SPD):

Represents the value of a parameter that is most likely to occur; the expected mean or average. It is not guaranteed by the product warranty.

General characteristics:

A general, descriptive term that does not imply a level of performance.

Corrected System Performance

The specifications in this section apply for measurements made with the Agilent E5071C Network Analyzer under the following conditions:

- No averaging applied to data
- Environmental temperature of 23 °C ± 5 °C, with less than 1 °C deviation from the calibration temperature
- Response and isolation calibration not omitted

Table 1-1 System dynamic range

Description	Specification	SPD
System Dynamic Range^{1,2}		
9 to 300 kHz	IF bandwidth = 3 kHz	
300 kHz to 10 MHz		
10 MHz to 6 GHz		
6 to 8.5 GHz		
9 to 300 kHz	IF bandwidth = 10 Hz	130 dB
300 kHz to 10 MHz		
10 MHz to 6 GHz		
6 to 8.5 GHz		

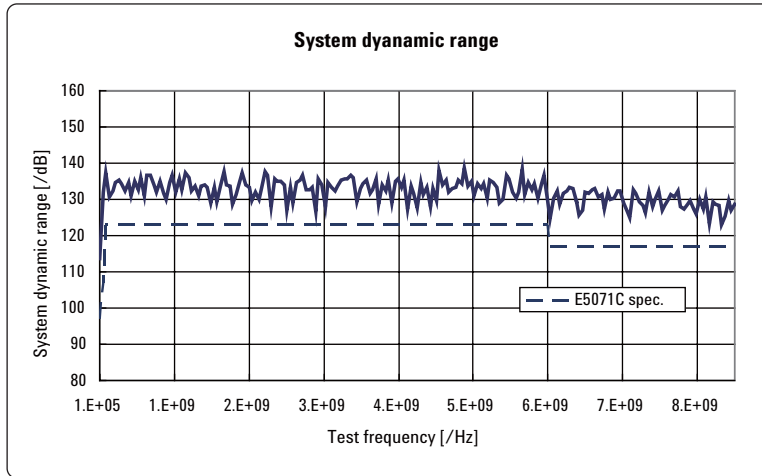

Figure 1. System dynamic range; specification and measurement data example. IF bandwidth is 10 Hz

1. The test port dynamic range is calculated as the difference between the test port rms noise floor and the source maximum output power. The effective dynamic range must take measurement uncertainty and interfering signals into account.
2. The specification might not be met when the frequency is 5 MHz or 50 MHz.

Table 1-2 Corrected system performance with type-N device connectors, 85032F calibration kit

Network analyzer: E5071C
 calibration kit: 85032F (type-N, 50 Ω)
 calibration: full 2-port

IF bandwidth = 10 Hz, no averaging applied to data, environmental temperature = 23 °C ± 5 °C with < 1 °C deviation from calibration temperature, isolation calibration not omitted

Description	Specification (dB)				
	9 to 300 kHz	300 kHz to 10 MHz	10 MHz to 3 GHz	3 to 6 GHz	6 to 8.5 GHz
Directivity	49	49	46	40	38
Source Match	41	41	40	36	35
Load Match	48	48	46	40	37
Reflection Tracking	± 0.011	± 0.011	± 0.021	± 0.032	± 0.054
Transmission Tracking	± 0.035	± 0.035	± 0.018	± 0.056	± 0.088

Transmission uncertainty (specification)

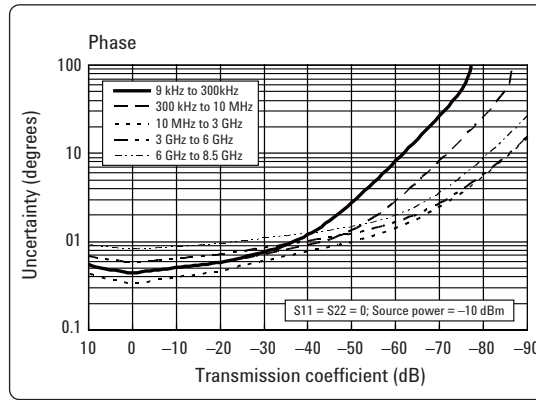
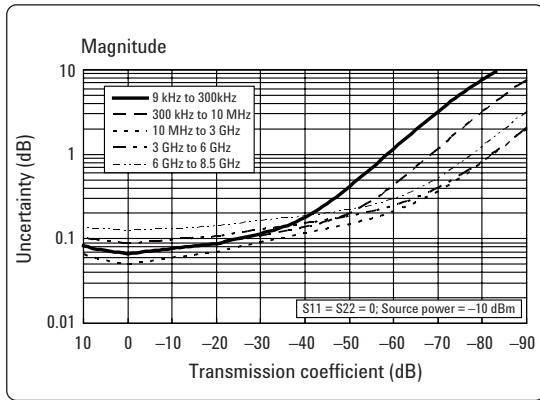

Reflection uncertainty (specification)

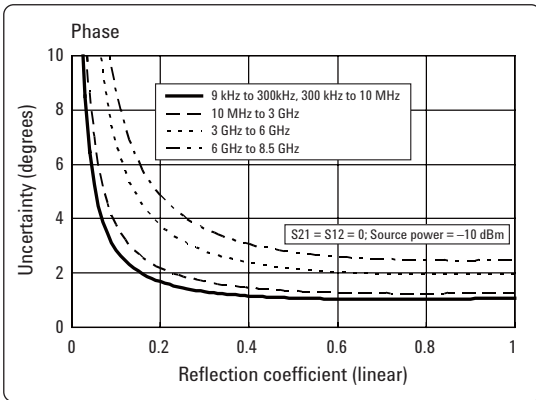
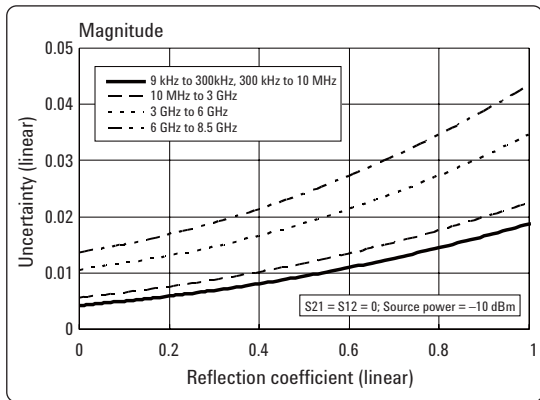

Table 1-3 Corrected system performance with type-N device connectors, 85092C electronic calibration module

Network analyzer: E5071C
 calibration module: 85092C (type-N, 50 Ω) electronic calibration (ECal) module
 calibration: full 2-port

IF bandwidth = 10 Hz, no averaging applied to data, environmental temperature = 23 °C ± 5 °C with < 1 °C deviation from calibration temperature, isolation calibration not omitted

Description	Specification (dB)			
	300 kHz to 10 MHz	10 MHz to 3 GHz	3 to 6 GHz	6 to 8.5 GHz
Directivity	52	54	52	47
Source match	45	44	41	36
Load match	47	47	44	39
Reflection tracking	± 0.040	± 0.040	± 0.060	± 0.070
Transmission tracking	± 0.041	± 0.039	± 0.068	± 0.136

Transmission uncertainty (specification)

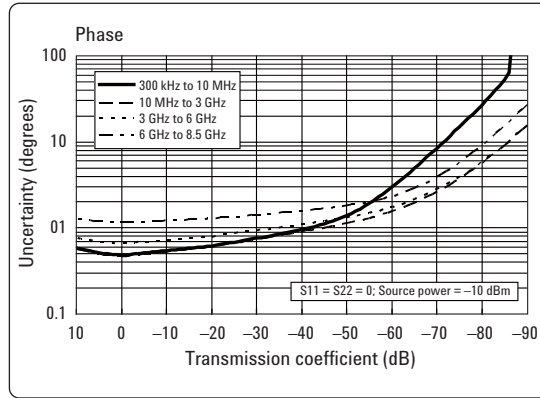
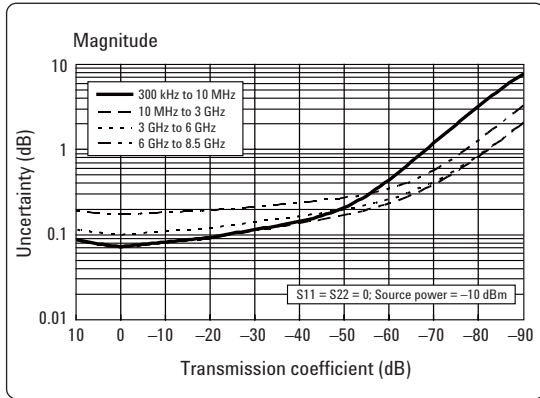

Reflection uncertainty (specification)

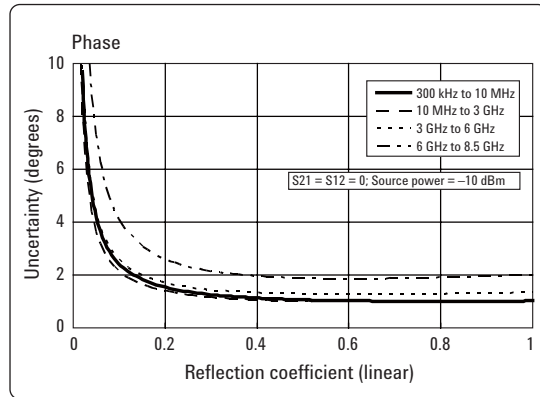
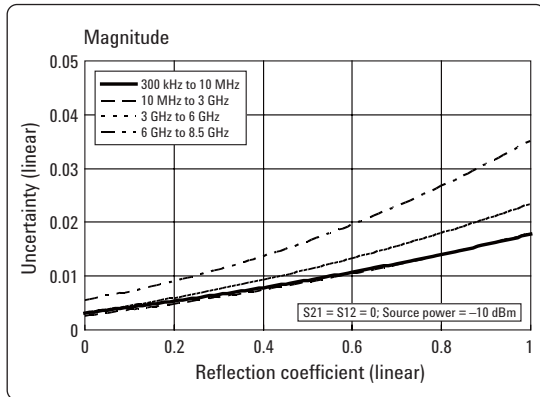

Table 1-4 Corrected system performance with 3.5 mm device connector type, 85033E calibration kit

Network analyzer: E5071C
 calibration kit: 85033E (3.5 mm, 50 Ω)
 calibration: full 2-port

IF bandwidth = 10 Hz, no averaging applied to data, environmental temperature = 23 °C ± 5 °C with < 1 °C deviation from calibration temperature, isolation calibration not omitted

Description	Specification (dB)				
	9 to 300 kHz	300 kHz to 10 MHz	10 MHz to 3 GHz	3 to 6 GHz	6 to 8.5 GHz
Directivity	46	46	44	38	38
Source match	43	43	40	37	35
Load match	46	46	44	38	38
Reflection tracking	± 0.006	± 0.006	± 0.007	± 0.009	± 0.010
Transmission tracking	± 0.034	± 0.034	± 0.020	± 0.058	± 0.079

Transmission uncertainty (specification)

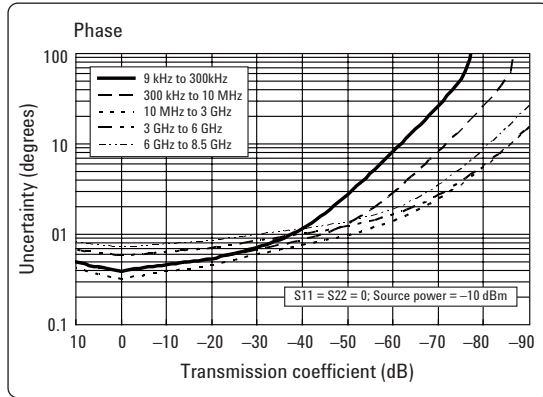
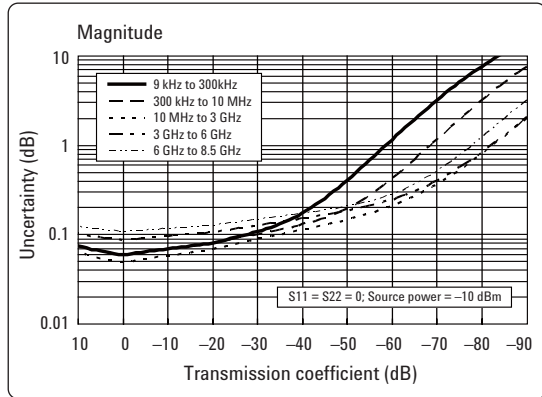

Relection uncertainty (specification)

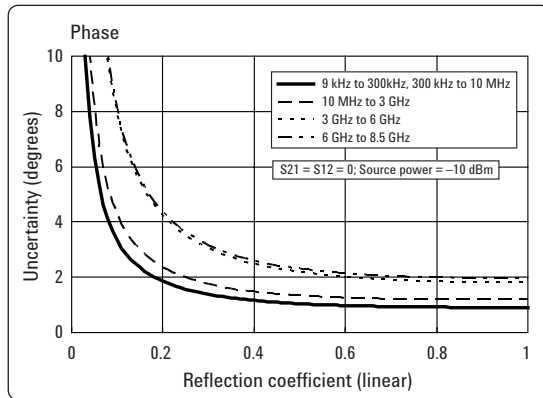
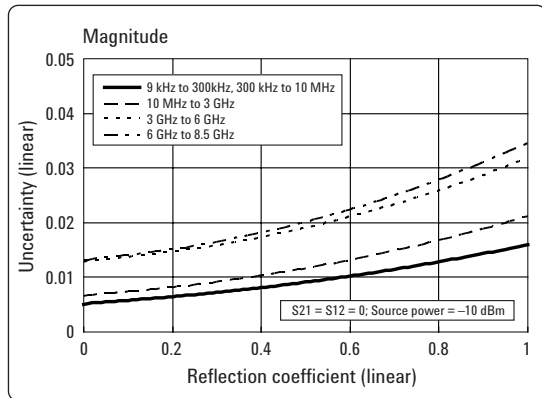

Table 1-5 Corrected system performance with 3.5 mm device connector type, 85093C electronic calibration module

Network analyzer: E5071C
calibration module: 85093C (3.5 mm, 50 Ω) electronic calibration (ECal) module
calibration: full 2-port

IF bandwidth = 10 Hz, no averaging applied to data, environmental temperature = 23 °C ± 5 °C with < 1 °C deviation from calibration temperature, isolation calibration not omitted

Description	Specification (dB)			
	300 kHz to 10 MHz	10 MHz to 3 GHz	3 to 6 GHz	6 to 8.5 GHz
Directivity	52	52	51	47
Source Match	44	44	39	34
Load Match	47	47	44	40
Reflection Tracking	± 0.030	± 0.040	± 0.050	± 0.070
Transmission Tracking	± 0.041	± 0.049	± 0.068	± 0.117

Transmission uncertainty (specification)

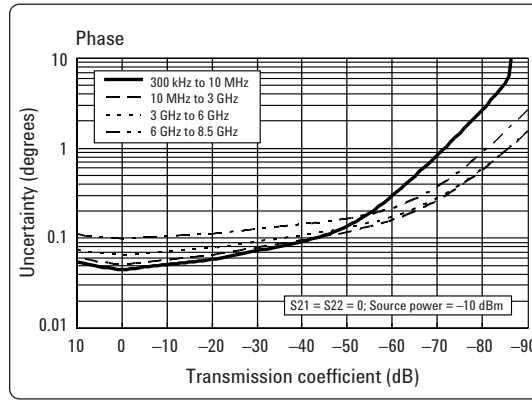
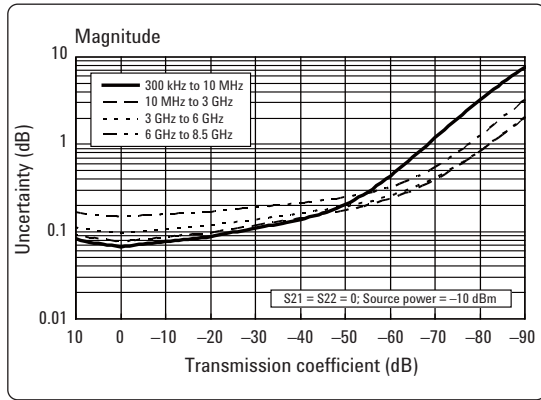

Reflection uncertainty (specification)

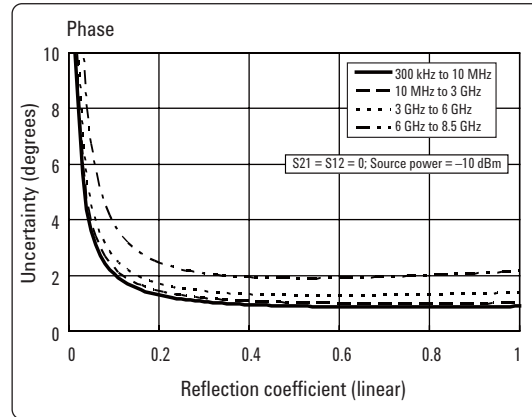
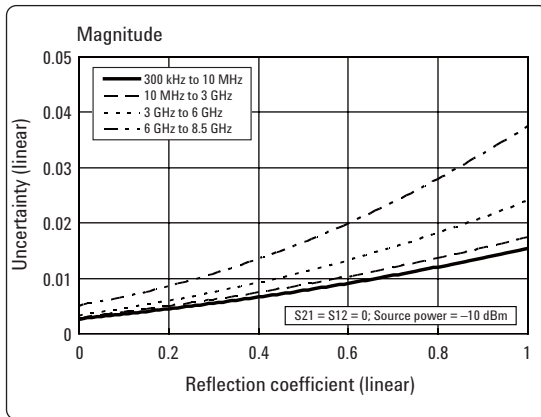

Uncorrected System Performance

Table 1-6 Uncorrected system performance
(User correction: Off, System correction: On)

Description	Specification (dB)			
	9 to 300 kHz	300 kHz to 3 GHz	3 to 6 GHz	6 to 8.5 GHz
Directivity	20	25	20	15
Source Match	20	25	20	15
Load Match	12	17	12	10
Transmission Tracking	± 1.5	± 1.0	± 1.0	± 1.0
Reflection Tracking	± 1.5	± 1.0	± 1.0	± 1.0

Test Port Output (Source)

Table 1-7 Test Port Output Frequency

Description	Specification	Typical
Range	9 kHz to 3 GHz (Opt. 230/430)	
	9 kHz to 8.5 GHz (Opt. 280/480)	
	100 kHz to 3 GHz (Opt. 235/435)	
	100 kHz to 8.5 GHz (Opt. 285/485)	
Resolution	1 Hz	
Source Stability		
Standard		± 5 ppm (5 to 40 °C)
Option 1E5		± 0.05 ppm (5 to 40 °C), ± 0.5 ppm/year
CW Accuracy		
Standard	± 5 ppm	
Option 1E5	± 1 ppm	

Test Port Output (Source)

Table 1-8 Test port output power¹

Description	Specification	Typical
Level Accuracy (stepped sweep mode)	± 0.650 dB (at 0 dBm, 50 MHz absolute) ± 1.0 dB (at 0 dBm, relative to 50 MHz reference)	
Level Accuracy (swept sweep mode)		± 2.5 dB (at 0 dBm, relative to 50 MHz reference)
Level Linearity (stepped sweep mode)		
9 kHz to 5 GHz	± 0.75 dB (–20 to 10 dBm)	
5 to 6 GHz	± 0.75 dB (–20 to 9 dBm)	
6 to 7 GHz	± 0.75 dB (–20 to 8 dBm)	
8 to 8.5 GHz	± 0.75 dB (–20 to 7 dBm) (relative to 0 dBm)	
Level Linearity (swept sweep mode)		
9 kHz to 5 GHz		± 1.5 dB (at –20 to 10 dBm)
5 to 6 GHz		± 1.5 dB (at –20 to 9 dBm)
6 to 7 GHz		± 1.5 dB (at –20 to 8 dBm)
7 to 8.5 GHz		± 1.5 dB (at –20 to 7 dBm) (relative to 0 dBm)
Range		
9 kHz to 5 GHz	–55 to 10 dBm	
5 to 6 GHz	–55 to 9 dBm	
6 to 7 GHz	–55 to 8 dBm	
7 to 8.5 GHz	–55 to 7 dBm	
Sweep Range		
9 kHz to 5 GHz	–55 to 10 dBm	
5 to 6 GHz	–55 to 9 dBm	
6 to 7 GHz	–55 to 8 dBm	
7 to 8.5 GHz	–55 to 7 dBm	
Level Resolution	0.05 dB	

Table 1-9 Test port output signal purity

Description	Specification	Typical
Harmonics (2nd or 3rd)		
9 kHz to 2 GHz		< –25 dBc (at 5 dBm)
2 to 8.5 GHz		< –20 dBc (at 5 dBm)
Non-Harmonic Spurious		
9 kHz to 8.5 GHz		< –30 dBc (at 5 dBm)

1. Source output performance on port 1 only. Other port output performance is typical.

Test Port Input

Table 1-10 Test port input levels

Description	Specification	Typical
Maximum Test Port Input Level		
9 kHz to 5 GHz	+10 dBm	
5 to 6 GHz	+9 dBm	
6 to 7 GHz	+8 dBm	
7 to 8.5 GHz	+7 dBm	
Damage Level		
9 kHz to 8.5 GHz		+26 dBm ± 35 VDC
Crosstalk¹		
9 to 300 kHz	-100 dB	
300 kHz to 10 MHz	-110 dB	
10 MHz to 3 GHz	-120 dB	
3 to 6 GHz	-110 dB	
6 to 8.5 GHz	-100 dB	

Table 1-11 Test port input (trace noise)

Description	Specification	SPD
Trace Noise Magnitude²		
9 to 30 kHz (IFBW = 3 kHz) (test port maximum input level = +10 dBm)	0.004 dBrms	
30 kHz to 10 MHz (IFBW = 3 kHz) (test port maximum input level = +10 dBm)	0.003 dBrms	
10 MHz to 4.38 GHz (IFBW = 70 kHz) (test port maximum input level = +10 dBm)	0.004 dBrms	0.001 dBrms
4.38 to 8.5 GHz (IFBW = 70 kHz) (test port maximum input level = +8 dBm)	0.006 dBrms	
Trace Noise Phase¹		
9 to 30 kHz (IFBW = 3 kHz) (test port maximum input level = +10 dBm)	0.035 °rms	
30 kHz to 10 MHz (IFBW = 3 kHz) (test port maximum input level = +10 dBm)	0.020 °rms	
10 MHz to 4.38 GHz (IFBW = 70 kHz) (test port maximum input level = +10 dBm)	0.035 °rms	
4.38 to 8.5 GHz (IFBW = 70 kHz) (test port maximum input level = +8 dBm)	0.050 °rms	

1. The specification might not be met when the frequency is 5 MHz or 50 MHz.

2. The specification might not be met when the frequencies are 333.333 kHz, 406.25 kHz, 857.143 kHz, 928.571 kHz, 1.3 MHz, 2.4 MHz and 4.333333 MHz.

Table 1-12 Test port input (stability)¹

Description	Specification	Typical
Stability Magnitude		
9 kHz to 3 GHz		± 0.005 dB/°C
3 to 6 GHz		± 0.010 dB/°C
6 to 8.5 GHz		± 0.040 dB/°C
Stability Phase		
9 kHz to 3 GHz		± 0.1 °/°C
3 to 6 GHz		± 0.2 °/°C
6 to 8.5 GHz		± 0.8 °/°C

Table 1-13 Test port input (dynamic accuracy)

Accuracy of the test port input power reading is relative to -10 dBm reference input power level.

Description	Specification	Typical
Dynamic Accuracy Magnitude		
10 dBm	± 0.21 dB	
-30 dBm	± 0.05 dB	
-100 dBm	± 2.01 dB	
Dynamic Accuracy Phase		
10 dBm		± 5 °
-30 dBm		± 0.3 °
-100 dBm		± 15.1 °

Specification

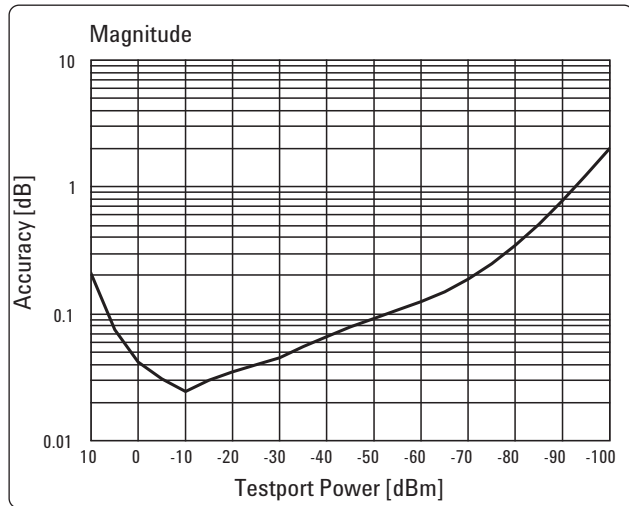

Typical

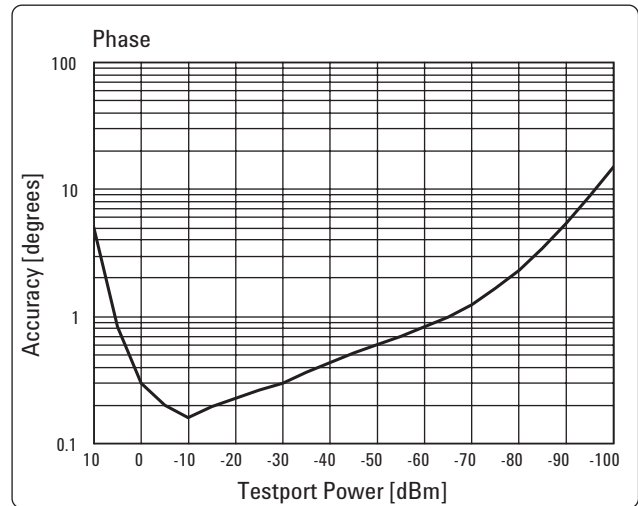

± 3.0 dB (at -110 dBm, Ref. = -10 dBm, Typ)

1. Stability is defined as a ratio measurement at the test port.

Table 1-14 Test port input (group delay)¹

Description	Specification	Supplemental Information
Aperture (selectable)	(frequency span)/ (number of points – 1)	
Maximum Aperture	25% of frequency span	
Minimum Delay		Limited to measuring no more than 180 °C of phase change within the minimum aperture.
Accuracy		See graph below, typical

The following graph shows group delay accuracy with type-N full 2-port calibration and a 10 Hz IF bandwidth. Insertion loss is assumed to be < 2 dB.

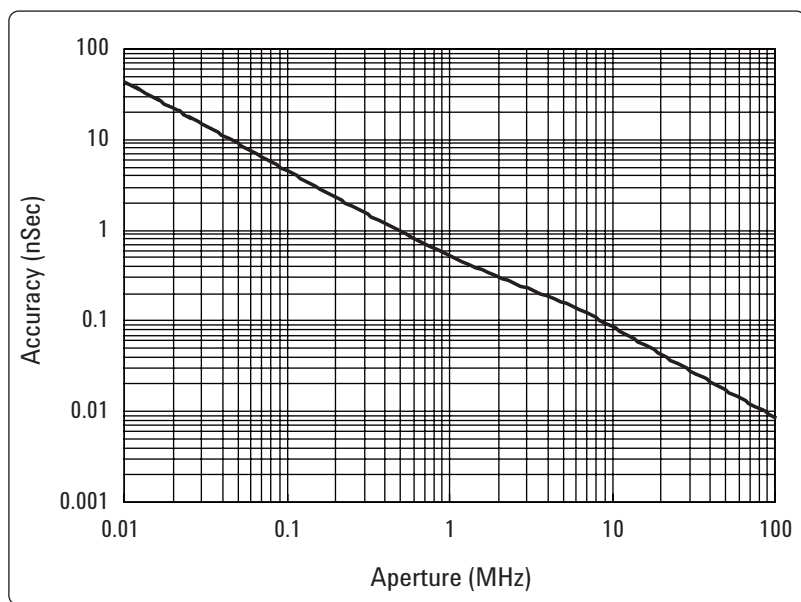

In general, the following formula can be used to determine the accuracy, in seconds, of specific group delay measurement: $\pm \text{Phase Accuracy (degrees)} / [360 \times \text{Aperture (Hz)}]$

1. Group delay is computed by measuring the phase change within a specified step (determined by the frequency span and the number of points per sweep).

General Information

Table 1-15 System bandwidths

Description	General Characteristics
IF Bandwidth Settings	
Range	10 Hz to 500 kHz Nominal settings are: 10, 15, 20, 30, 40, 50, 70, 100, 150, 200, 300, 400, 500, 700, 1 k, 1.5 k, 2 k, 3 k, 4 k, 5 k, 7 k, 10 k, 15 k, 20 k, 30 k, 40 k, 50 k, 70 k, 100 k, 150 k, 200 k, 300 k, 400 k, 500 kHz

Table 1-16 Front panel information

Description	Typical	General Characteristics
RF Connectors		
Type		Type-N, female, 50 Ω
Probe Power		
Connector		3 terminal connector x 2
Voltage & Maximum Current	+15 V ± 2 % (400 mA) -12.6 V ± 5 % (300 mA) (Combined load for both probe connections)	
Display		
Type		10.4 in TFT color LCD with Touch screen
Resolution		XGA (1024 x 768) ¹

1. Valid pixels are 99.99 % and more. Below 0.01 % (approx. 30 points) of fixed points of black, blue, green or red are not regarded as failure.

Table 1-17 Rear panel information

Description	Typical	General Characteristics
External Trigger Input Connector		
Type		BNC, female
Input level		LOW threshold voltage: 0.5 V HIGH threshold voltage: 2.1 V Input level range: 0 to + 5 V
Pulse width		$\geq 2 \mu\text{s}$
Polarity		Positive or Negative
External Trigger Output Connector		
Type		BNC, female
Maximum output current		50 mA
Output level		LOW level voltage : 0 V HIGH level voltage : 5 V
Pulse width		1 μs
Polarity		Positive or Negative
External Reference Signal Input Connector		
Type		BNC, female
Input Frequency	10 MHz \pm 10 ppm	
Input Level	-3 to +10 dBm	
Internal Reference Signal Output Connector		
Type		BNC, female
Output Frequency	10 MHz \pm 5 ppm	
Signal Type	Sine Wave	
Output Level	0 dBm \pm 3 dB into 50 Ω	
Output Impedance		50 Ω
Internal Reference Signal Oven Connector		
Type		BNC, female
Output Frequency	10 MHz \pm 1 ppm	
Output Level	0 dBm minimum	
Bias Tee Input Connector		
Type		BNC, female (for each port)
Maximum Voltage		± 35 VDC
Maximum Current		± 500 mA
Fuse		500 mA, bi-pin style
Video Output		
		15-pin mini D-Sub; female; drives XGA compatible monitors
GPIB		
		24-pin D-Sub (Type D-24), female; compatible with IEEE-488
Parallel Port		
		36-pin D-Sub (Type 1284-C), female; provides connection to printers

Description	Typical	General Characteristics
USB-Host Port		
		Universal Serial Bus jack, Type A configuration (4 contacts inline, contact 1 on left); female; provides connection to printer, ECal module, USB/GPIB interface or multiport test set; compatible with USB 2.0.
Contact 1		Vcc: 4.75 to 5.25 VDC, 500 mA, maximum
Contact 2		-Data
Contact 3		+Data
Contact 4		Ground
USB (USBTMC¹) interface Port		
		Universal Serial Bus jack, Type B configuration (4 contacts inline); female; provides connection to an external PC; compatible with USBTMC-USB488 and USB 2.0.
LAN		
		10/100BaseT Ethernet, 8-pin configuration; auto selects between the two data rates
Handler I/O Port		
		36-pin centronics, female; provides connection to handler system
Line Power²		
Frequency		47 to 63 Hz
Voltage		90 to 132 VAC, or 198 to 264 VAC (automatically switched)
VA Max		350 VA max.
AUX Input Connector		
Type		BNC, female x 2
Input Range		±1 V or ±10 V selectable
Accuracy	1 % +1 mV for ± 1 V input 1 % +10 mV for ± 10 V input	

1. USB Test and Measurement Class (TMC) interface that communicates over USB, complying with the IEEE 488.1 and IEEE 488.2 standards.
2. A third-wire ground is required.

Table 1-18 EMC, safety and environment





Description	General Characteristics
EMC	
 ISM 1-A	<p>European Council Directive 89/336/EEC, 92/31/EEC, 93/68/EEC IEC 61326-1:1997 +A1:1998 +A2:2000 EN 61326-1:1997 +A1:1998 +A2:2001 CISPR 11:1997 +A1:1999 +A2:2002 EN 55011:1998 +A1:1999 +A2:2002 Group 1, Class A IEC 61000-4-2:1995 +A1:1998 +A2:2001 EN 61000-4-2:1995 +A1:1998 +A2:2001 4 kV CD / 8 kV AD IEC 61000-4-3:1995 +A1:1998 +A2:2001 EN 61000-4-3:1996 +A1:1998 +A2:2001 3 V/m, 80-1000 MHz, 80% AM IEC 61000-4-4:1995 +A1:2001 +A2:2001 EN 61000-4-4:1995 +A1:2001 +A2:2001 1 kV power / 0.5 kV Signal IEC 61000-4-5:1995 A1:2001 EN 61000-4-5:1995 A1:2001 0.5 kV Normal / 1 kV Common IEC 61000-4-6:1996 A1:2001 EN 61000-4-6:1996 A1:2001 3 V, 0.15-80 MHz, 80% AM IEC 61000-4-11:1994 +A1:2001 EN 61000-4-11:1994 +A1:2001 100% 1cycle Note: The performance criterion B is adopted for ESD immunity test, and criterion A for other immunity tests. Temporary deviation from test limit due to accidental measurement of test signal is considered normal performance.</p>
ICES/NMB-001	<p>This ISM device complies with Canadian ICES-001:1998. Cet appareil ISM est conforme à la norme NMB-001 du Canada.</p>
 N10149	<p>AS/NZS 2064.1 Group 1, Class A</p>
Safety	
 ISM 1-A	<p>European Council Directive 73/23/EEC, 93/68/EEC IEC 61010-1:2001 / EN 61010-1:2001 Measurement Category I Pollution Degree 2 Indoor Use IEC60825-1:1994 CLASS 1 LED</p>
 LR95111C	<p>CAN/CSA C22.2 No. 61010-1-04 Measurement Category I Pollution Degree 2 Indoor Use</p>
Environment	
	<p>This product complies with the WEEE Directive (2002/96/EC) marking requirements. The affixed label indicates that you must not discard this electrical/ electronic product in domestic household waste.</p> <p>Product Category : With reference to the equipment types in the WEEE Directive Annex I, this product is classed as a "Monitoring and Control instrumentation" product.</p> <p>Do not dispose in domestic household waste.</p> <p>To return unwanted products, contact your local Agilent office, or see www.agilent.com/environment/product/ for more information.</p>

Table 1-19 Analyzer environment and dimensions

Description	General Characteristics
Operating Environment	
Temperature	+5 to +40 °C
Error-Corrected	23 °C ± 5 °C with < 1 °C deviation from calibration temperature
Temperature Range	
Humidity	20 to 80% at wet bulb temperature < +29 °C (non-condensing)
Altitude	0 to 2,000 m (0 to 6,561 feet)
Vibration	0.21 G maximum, 5 to 500 Hz
Non-Operating Storage Environment	
Temperature	-10 to +60 °C
Humidity	20 to 90% at wet bulb temperature < +40 °C (non-condensing)
Altitude	0 to 4,572 m (0 to 15,000 feet)
Vibration	0.5 G maximum, 5 to 500 Hz
Dimensions	
	See below.
Weight (net)	
	18.2 kg (2-port Opt. 230/280)
	18.3 kg (2-port Opt. 235/285)
	19.9 kg (4-port Opt. 430/480)
	20.0 kg (4-port Opt. 435/485)

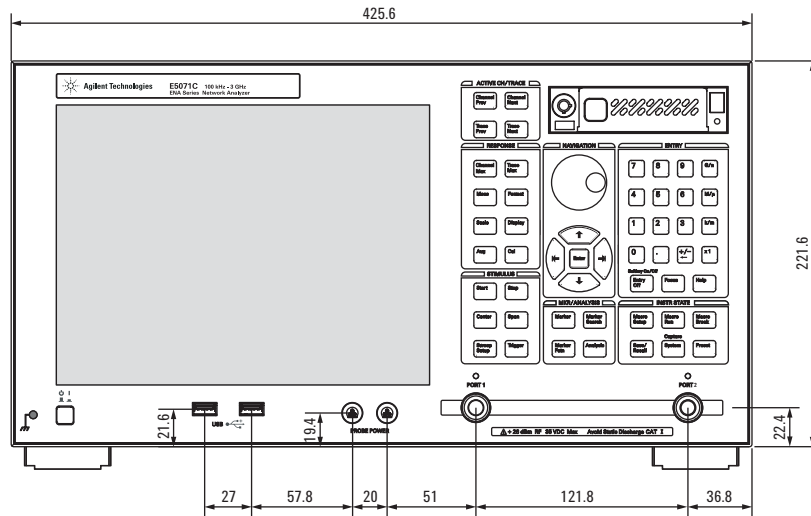

Figure 2. Dimensions (front view, E5071C with option 230/235/280/285, in millimeters)

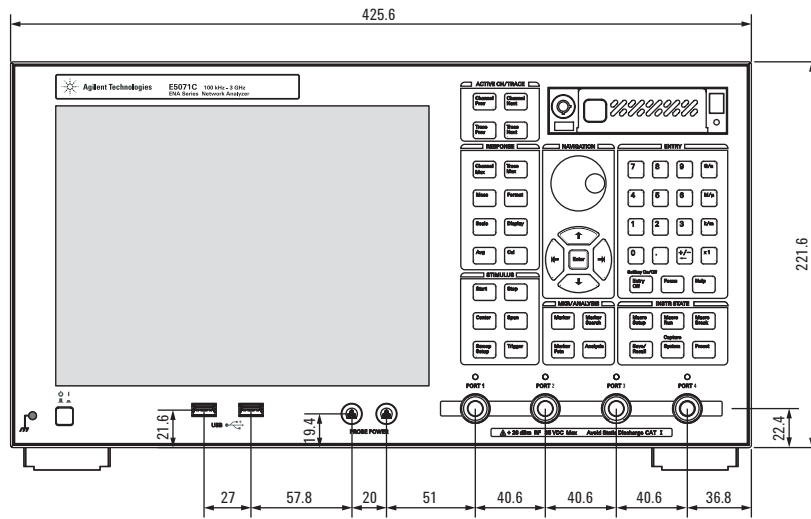

Figure 3. Dimensions (front view, E5071C with option 430/435/480/485, in millimeters)

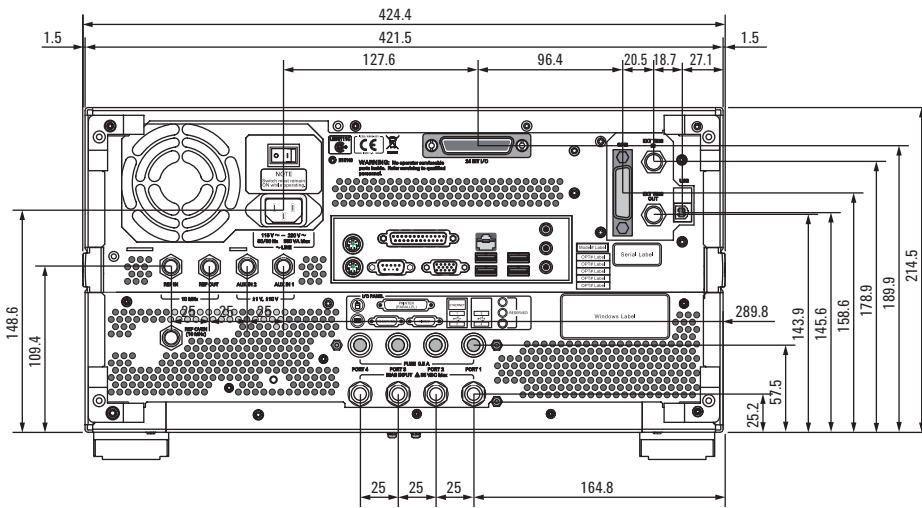

Figure 4. Dimensions (rear view, with option 1E5, in millimeters)

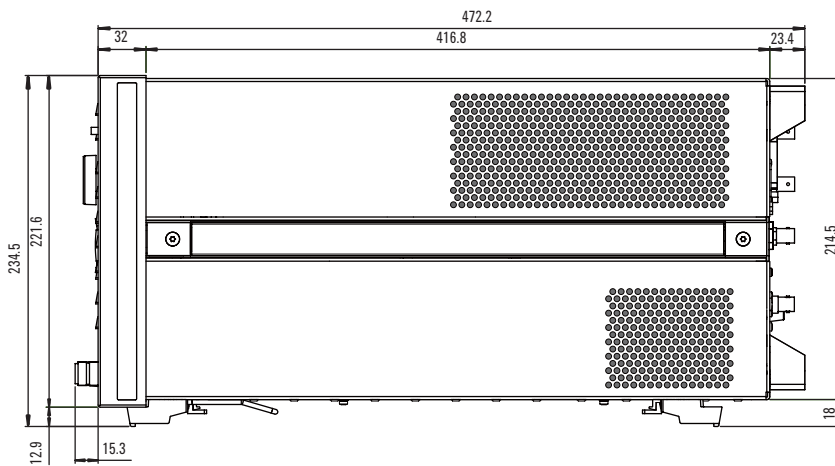

Figure 5. Dimensions (side view, in millimeters)

Measurement Throughput Summary

Table 1-20 Typical cycle time for measurement completion^{1,2} (ms)

	Number of Points			
	51	201	401	1601
Start 1 GHz, Stop 1.2 GHz, 500 kHz IF bandwidth				
Uncorrected	3.91	5.13	6.90	17.60
2-port cal	6.19	8.80	12.88	38.95
Start 100 kHz, Stop 3 GHz, 500 kHz IF bandwidth				
Uncorrected	8.54	10.57	11.67	21.37
2-port cal	16.62	20.64	22.81	45.69
Start 100 kHz, Stop 8.5 GHz, 500 kHz IF bandwidth				
Uncorrected	13.93	17.23	18.48	20.93
2-port cal	27.43	33.90	36.27	45.83

Table 1-21 Typical cycle time for measurement completion^{1,3} (ms)

	Number of Points			
	51	201	401	1601
Start 1 GHz, Stop 1.2 GHz, 500 kHz IF bandwidth				
Uncorrected	3.96	5.67	7.58	19.64
2-port cal	6.25	9.19	13.71	44.58
Start 100 kHz, Stop 3 GHz, 500 kHz IF bandwidth				
Uncorrected	8.54	11.09	11.70	23.15
2-port cal	16.73	20.67	23.05	49.61
Start 100 kHz, Stop 8.5 GHz, 500 kHz IF bandwidth				
Uncorrected	14.12	17.94	18.60	23.08
2-port cal	27.52	34.00	36.72	48.75

Table 1-22 Typical cycle time for measurement completion^{1,4} (ms)

	Number of Points			
	51	201	401	1601
Start 1 GHz, Stop 1.2 GHz, 500 kHz IF bandwidth				
Uncorrected	4.27	7.51	11.18	28.12
2-port cal	8.14	14.48	22.60	55.43
Start 100 kHz, Stop 3 GHz, 500 kHz IF bandwidth				
Uncorrected	6.53	11.84	17.81	46.89
2-port cal	12.62	23.16	34.91	93.03
Start 100 kHz, Stop 8.5 GHz, 500 kHz IF bandwidth				
Uncorrected	6.91	12.27	18.10	46.70
2-port cal	13.38	24.02	35.50	92.61

1. Typical performance.
2. Sweep mode: Swept. Analyzer display turned off with :DISP:ENAB OFF. Number of traces = 1. System error correction: OFF.
3. Sweep mode: Swept. Analyzer display turned off with :DISP:ENAB Off. Number of traces = 1. System error correction: ON.
4. Sweep mode: Stepped. Analyzer display turned off with :DISP:ENAB OFF. Number of traces = 1. System error correction: ON.

Table 1-23 Cycle time (ms)^{1,2} vs. number of points

Number of Points	Sweep mode: Swept	Sweep mode: Swept	Sweep mode: Stepped
	System error correction: OFF	System error correction: ON	System error correction: ON
3	3.46	3.40	3.38
11	3.58	3.45	3.46
51	3.91	3.96	4.27
101	4.19	4.44	5.44
201	5.13	5.67	7.51
401	6.90	7.58	11.18
801	10.15	11.69	17.75
1601	17.60	19.64	28.12

Table 1-24 Data transfer time¹ (ms)

	Number of Points			
	51	201	401	1601
SCPI over GPIB³				
64-bit floating point	4	12	22	86
32-bit floating point	3	7	13	51
ASCII	24	90	182	715
SCPI over 100 Mbps LAN (Telnet)³				
REAL 64	2	2	2	4
REAL 32	2	2	2	3
ASCII	19	104	157	673
SCPI over 100 Mbps LAN (SICL-LAN)³				
REAL 64	4	4	4	7
REAL 32	3	4	4	6
ASCII	4	8	14	53
SCPI over USB (SICL-USB)³				
REAL 64	3	3	3	4
REAL 32	3	3	3	3
ASCII	4	10	22	86
SCPI over GPIB/USB (82357A)³				
REAL 64	20	27	35	85
REAL 32	18	21	31	60
ASCII	69	239	471	1916
COM⁴				
Variant type	1	1	1	1

1. Typical performance.
2. Start 1 GHz, Stop 1.2 GHz, 500 kHz IF bandwidth, Error correction: OFF, Display update: OFF, Number of traces = 1.
3. Measured using a VEE Pro 7.0 program running on a 3.2 GHz Pentium 4 DELL Precision 370, Transferred complex S11 data, using :CALC{1-36}:DATA:FDAT?.
4. Measured using an E5071C VBA macro running inside the analyzer. Transferred complex S11 data.

E5091A multiport test set

The section provides test set input/output performance without calibration by the E5071C.

Table 2-1 Test set input/output performance

Description	Specification	Typical
Range	50 MHz to 8.5 GHz	
Damage level		20 dBm, ±25 VDC (typical)

Table 2-2 Option E5091A-009 port performance

Description	Specification				
	50 to 300 MHz	300 MHz to 1.3 GHz	1.3 to 3 GHz	3 to 6 GHz	6 to 8.5 GHz
Load match					
Test port selected					
A, T2, R1+, R1–	19 dB	20 dB	18 dB	12 dB	10 dB
T1, R2+, R2–, R3+, R3–	15 dB	17 dB	15 dB	11 dB	8 dB
Test port unselected					
A, T2, R1+, R1–, R3+, R3–	23 dB	25 dB	19 dB	12 dB	11 dB
T1, R2+, R2–	18 dB	20 dB	16 dB	12 dB	9 dB
Interconnect port, typical					
P1, P2, P3, P4	19 dB	19 dB	17 dB	13 dB	9 dB
Insertion loss					
Test port					
A, T2, R1+, R1–	3 dB	3 dB	4 dB	5 dB	6 dB
T1, R2+, R2–, R3+, R3–	5 dB	5 dB	7 dB	8 dB	9.5 dB
Stability, typical	0.005 dB/ °C	0.005 dB/ °C	0.005 dB/ °C	0.01 dB/ °C	0.015 dB/ °C
Isolation					
Over arbitrarily test ports	–100 dB	–100 dB	–100 dB	–100 dB	–90 dB

Table 2-3 Option E5091A-016 port performance

Description	Specification				
	50 to 300 MHz	300 MHz to 1.3 GHz	1.3 to 3 GHz	3 to 6 GHz	6 to 8.5 GHz
Load match					
Test port selected					
A, T4, R1+, R1-, R2+, R2-, R3+, R3-, R4+, R4-	15 dB	17 dB	15 dB	9 dB	8 dB
T1, T2, T3	12 dB	14 dB	14 dB	8 dB	6 dB
Test port unselected					
A, T4, T2, R1+, R1-, R2+, R2-, R3+, R3-, R4+, R4-, R4-	18 dB	20 dB	16 dB	10 dB	9 dB
T1, T2, T3	13 dB	15 dB	14 dB	8 dB	6 dB
Interconnect port, typical					
P1, P2, P3, P4	12 dB	12 dB	12 dB	9 dB	7 dB
Insertion loss					
Test port					
A, T4, R1+, R1-, R2+, R2-, R3+, R3-, R4+, R4-	6 dB	6 dB	7 dB	8 dB	9.5 dB
T1, T2, T3	6 dB	9 dB	10.5 dB	12 dB	14.5 dB
Stability per switch, typical	0.005 dB/ °C	0.005 dB/ °C	0.005 dB/ °C	0.01 dB/ °C	0.015 dB/ °C
Isolation					
Over arbitrarily test ports	-100 dB	-100 dB	-100 dB	-100 dB	-80 dB

Table 2-4 Front panel information

Description	General characteristics
RF connectors	
Interconnect ports	Type Type-N, female, 50 Ω, nominal Number of ports 4 ports
Test ports (Option E5091A-009)	Type Type-N, female, 50 Ω, nominal Number of ports 9 ports
Test ports (Option E5091A-016)	Type SMA, female, 50 Ω, nominal Number of ports 25 ports (includes configurable switch port)
Control line	15 pin D-sub, female

Table 2-5 Rear panel information

Description	General characteristics
USB port	Type B-receptacles, provide connection to the E5071C
Line power¹	
Frequency	47 to 63 Hz
Voltage	90 to 132 VAC, or 198 to 264 VAC (automatically switched)
VA max	150 VA max.

1. 1 A third-wire ground is required.

For EMC, safety and environment information, refer to E5071C section.

Table 2-6 Test set dimensions and block diagram

Description	General characteristics
Dimensions	
Option E5091A-009	See figure 2-1, 2-3, and 2-4
Option E5091A-016	See figure 2-2, 2-3, and 2-5
Weight	
Option E5091A-009	6 kg
Option E5091A-016	7 kg
Block diagram	
Option E5091A-009/016	See figure 2-6

Figure 2-1 Dimensions (front view, with option E5091A-009, in millimeters, nominal)

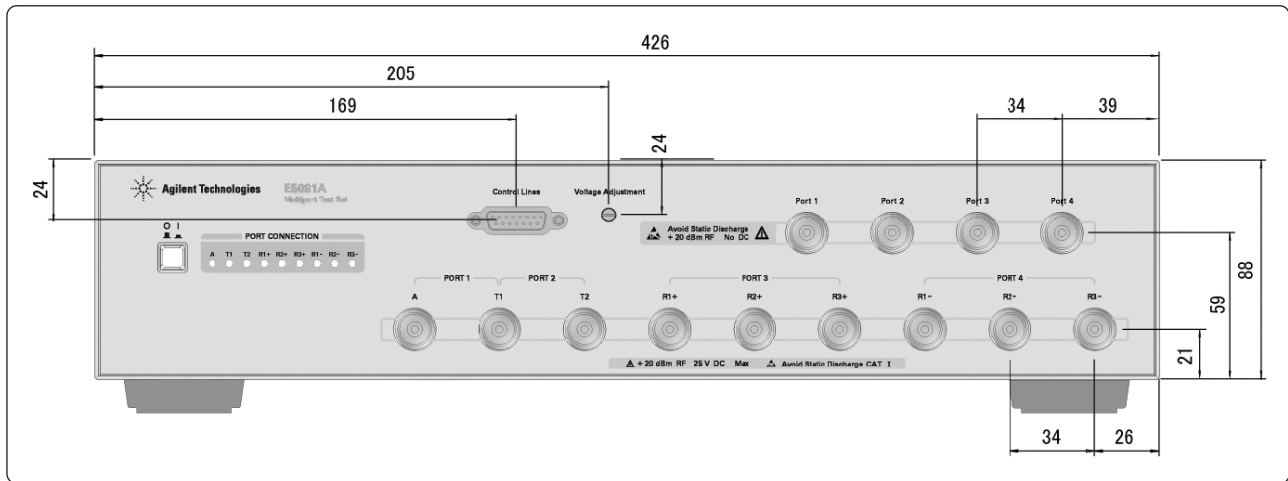

Figure 2-2 Dimensions (front view, with option E5091A-016, in millimeters, nominal)

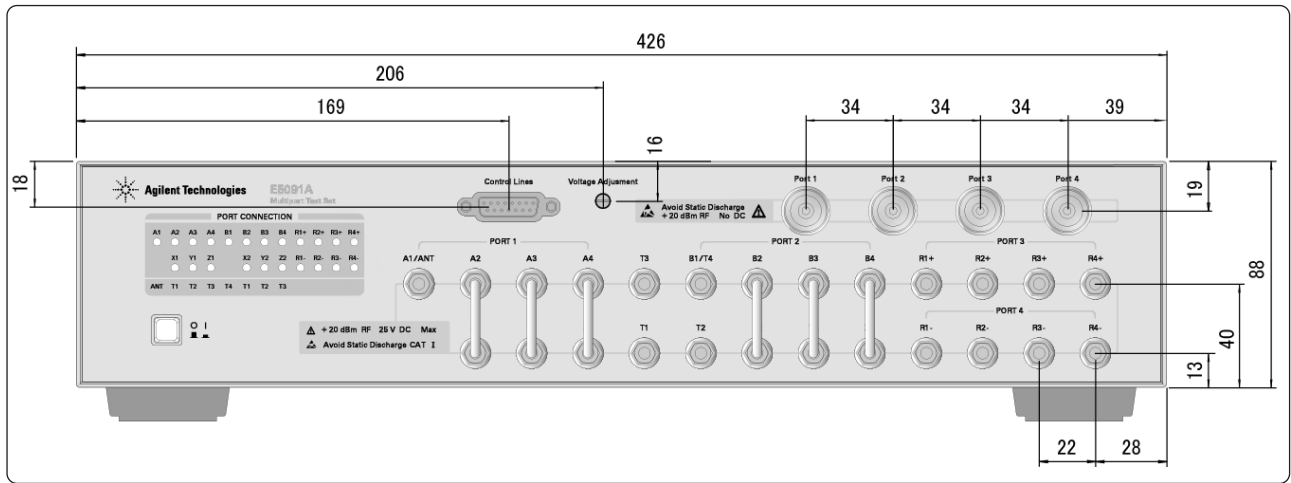

Figure 2-3 Dimensions (rear view, in millimeters, nominal)

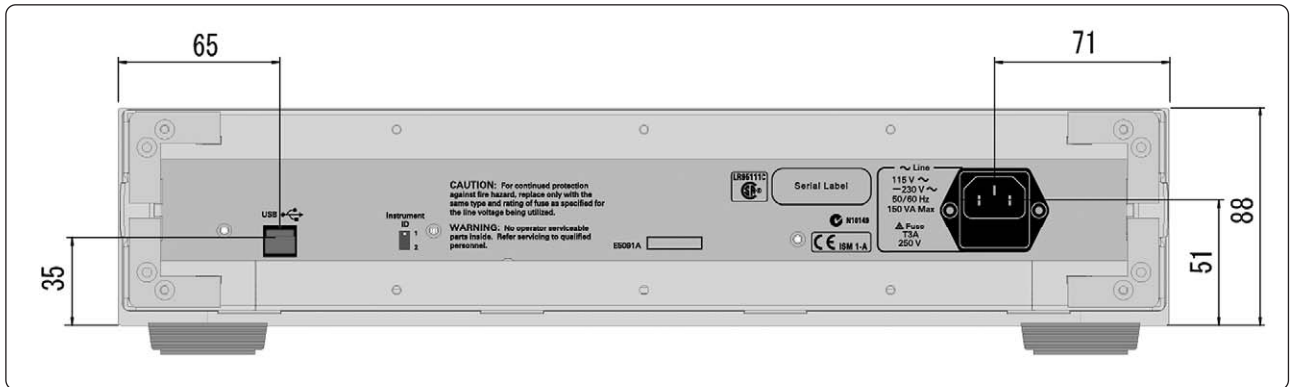

Figure 2-4 Dimensions (side view, with Option E5091A-009, in millimeters, nominal)

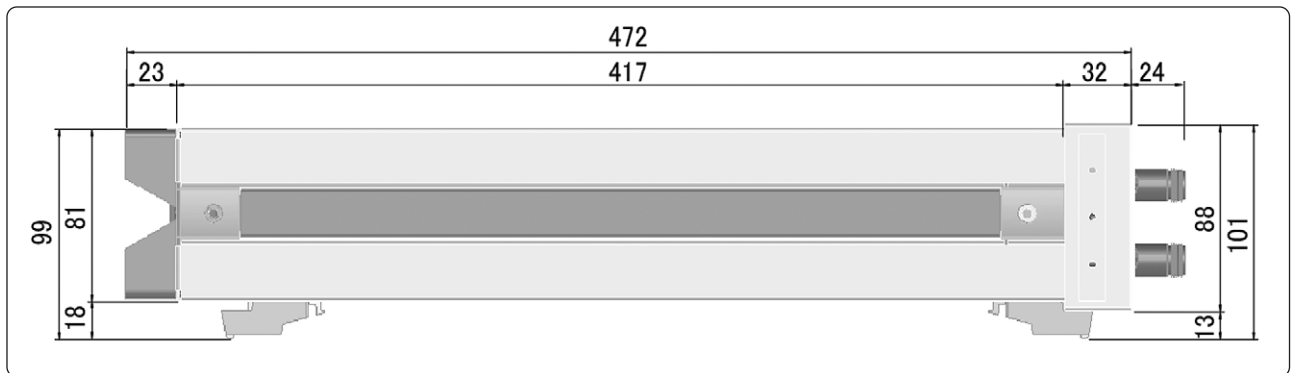

Figure 2-5 Dimensions (side view, with Option E5091A-016, in millimeters, nominal)

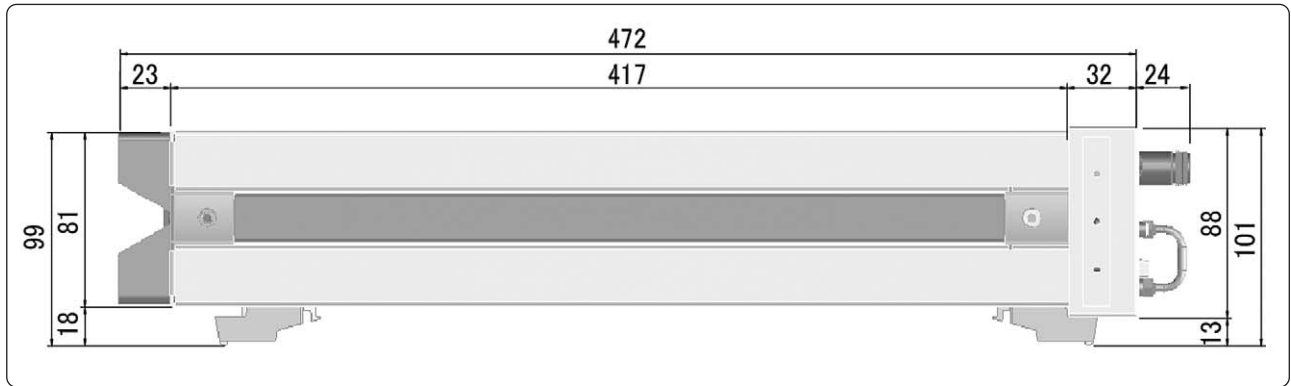
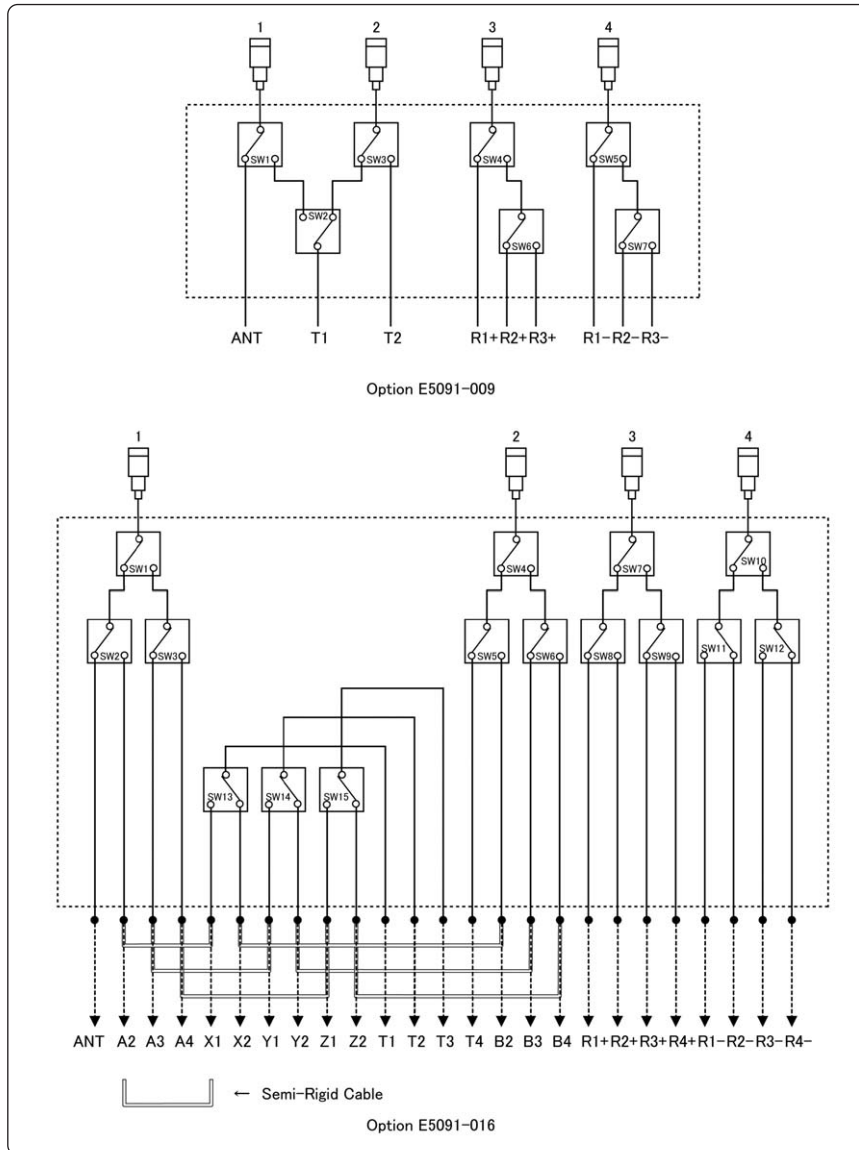

Figure 2-6 Block diagram



Corrected system performance for 75 Ω measurements with 11852B 50 to 75 Ω minimum-loss pads (supplemental information)

Table 3-1 Corrected system performance with type-N 75 Ω device connectors, 85036E calibration kit

Network analyzer: **E5071C**
 calibration kit: **85036E (type-N 75 Ω)**
 50 to 75 Ω adapters: **11852B**
 calibration: **full 2-port**

IF bandwidth = 10 Hz, no averaging applied to data, environmental temperature = 23 °C
 ± 5° C with < 1 °C deviation from calibration temperature, Isolation calibration not omitted

Description	Typical (dB)
	10 MHz to 3 GHz
Directivity	37
Source match	33
Load match	39
Reflection tracking	± 0.015
Transmission tracking	± 0.019

Transmission uncertainty 10 MHz to 3 GHz (typical)

Magnitude

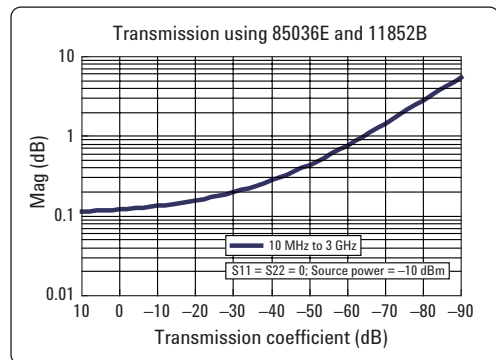

Phase

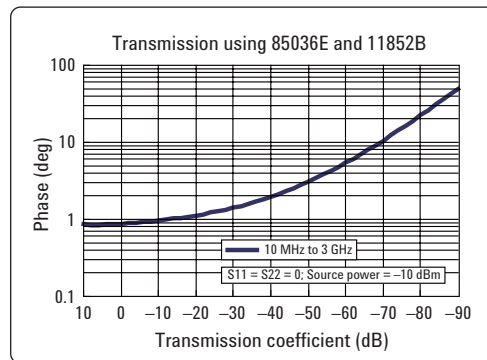

Reflection uncertainty 10 MHz to 3 GHz (typical)

Magnitude

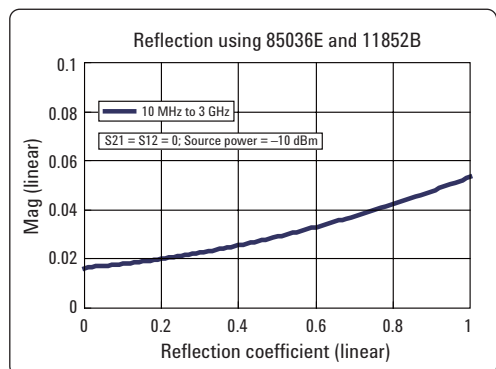

Phase

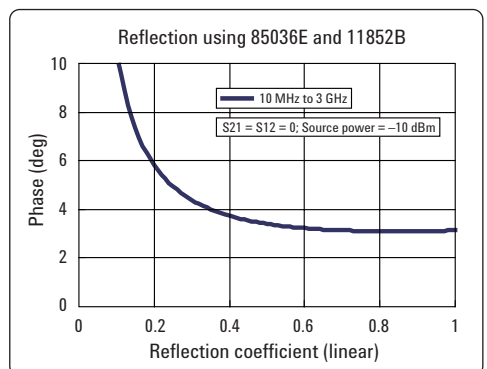

www.agilent.com

Remove all doubt

Without a doubt, our repair and calibration services will get your equipment back to performing like new. Without a doubt, we will get it back to you fast and when promised. We help you get full value out of your Agilent equipment throughout its lifetime. Your equipment will be serviced by Agilent-trained technicians using the latest factory calibration procedures, automated repair diagnostics and genuine parts, drawing from our unique access to the factory experts when necessary. This means that you will always have the utmost confidence in your measurements, so remove all doubt – use Agilent repair and calibration services for your instruments.

Agilent offers a wide range of additional expert test and measurement services for your equipment, including initial start-up assistance, onsite education and training, as well as design, system integration, and project management.

For more information on repair and calibration services, go to:

www.agilent.com/find/removealldoubt



Agilent Email Updates

www.agilent.com/find/emailupdates

Get the latest information on the products and applications you select.

Agilent
Open

LXI

www.agilent.com/find/open

Agilent Open simplifies the process of connecting and programming test systems to help engineers design, validate and manufacture electronic products. Agilent offers open connectivity for a broad range of system-ready instruments, open industry software, PC-standard I/O and global support, which are combined to more easily integrate test system development.

For more information on Agilent Technologies' products, applications or services, please contact your local Agilent office. The complete list is available at:

www.agilent.com/find/contactus

Phone or Fax

United States:

(tel) 800 829 4444
(fax) 800 829 4433

Canada:

(tel) 877 894 4414
(fax) 800 746 4866

China:

(tel) 800 810 0189
(fax) 800 820 2816

Europe:

(tel) 31 20 547 2111

Japan:

(tel) (81) 426 56 7832
(fax) (81) 426 56 7840

Korea:

(tel) (080) 769 0800
(fax) (080)769 0900

Latin America:

(tel) (305) 269 7500

Taiwan:

(tel) 0800 047 866
(fax) 0800 286 331

Other Asia Pacific Countries:

(tel) (65) 6375 8100
(fax) (65) 6755 0042

Email: tm_ap@agilent.com

Revised: 08/03/06

Product specifications and descriptions in this document subject to change without notice.

© Agilent Technologies, Inc. 2006
Printed in USA, September 20, 2006
5989-5479EN



Agilent Technologies