

Agilent ENA 2, 3 and 4 Port RF Network Analyzers

E5070B 300 kHz to 3 GHz

E5071B 300 kHz to 8.5 GHz

E5091A Multiport Test Set

Data Sheet

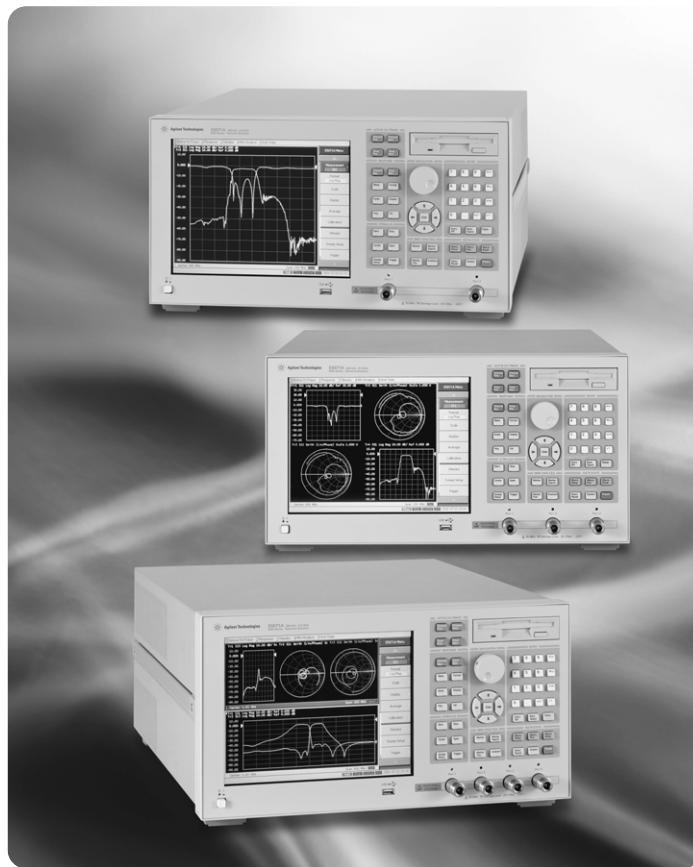

Agilent Technologies

Definitions

All specifications apply over a 5°C to 40°C range (unless otherwise stated) and 90 minutes after the instrument has been turned on.

Specification (spec.):

Warranted performance. Specifications include guardbands to account for the expected statistical performance distribution, measurement uncertainties, and changes in performance due to environmental conditions.

Supplemental information is intended to provide information that is helpful for using the instrument but that is not guaranteed by the product warranty. This information is denoted as either typical or nominal.

Typical (typ.):

Expected performance of an average unit that does not include guardbands. It is not guaranteed by the product warranty.

Nominal (nom.):

A general, descriptive term that does not imply a level of performance. It is not guaranteed by the product warranty.

Corrected system performance

The specifications in this section apply for measurements made with the Agilent E5070B/E5071B network analyzer with the following conditions:

- No averaging applied to data
- Environmental temperature of $23^{\circ}\text{C} \pm 5^{\circ}\text{C}$, with less than 1°C deviation from the calibration temperature
- Response and isolation calibration not omitted

Table 1-1 System dynamic range ^{1,2}

Description	Specification	Supplemental information
System dynamic range		
300 kHz to 3 MHz, IF bandwidth = 3 kHz		85 dB
3 MHz to 1.5 GHz, IF bandwidth = 3 kHz	95 dB	98 dB
1.5 GHz to 3 GHz, IF bandwidth = 3 kHz	97 dB	100 dB
3 GHz to 4 GHz, IF bandwidth = 3 kHz	96 dB	99 dB
4 GHz to 6 GHz, IF bandwidth = 3 kHz	92 dB	94 dB
6 GHz to 7.5 GHz, IF bandwidth = 3 kHz	87 dB	90 dB
7.5 GHz to 8.5 GHz, IF bandwidth = 3 kHz	80 dB	83 dB
300 kHz to 3 MHz, IF bandwidth = 10 Hz		110 dB
3 MHz to 1.5 GHz, IF bandwidth = 10 Hz	120 dB	123 dB
1.5 GHz to 3 GHz, IF bandwidth = 10 Hz	122 dB	125 dB
3 GHz to 4 GHz, IF bandwidth = 10 kHz	121 dB	124 dB
4 GHz to 6 GHz, IF bandwidth = 10 Hz	117 dB	119 dB
6 GHz to 7.5 GHz, IF bandwidth = 10 Hz	112 dB	115 dB
7.5 GHz to 8.5 GHz, IF bandwidth = 10 Hz	105 dB	108 dB

¹ The test port dynamic range is calculated as the difference between the test port rms noise floor and the source maximum output power. The effective dynamic range must take measurement uncertainty and interfering signals into account.

² May be limited to 90 dB at particular frequencies below 350 MHz or above 4.25 GHz due to spurious receiver residuals.

Table 1-2 Corrected system performance with type-N device connectors, 85032F calibration kit

Network analyzer: E5070B/E5071B, calibration kit: 85032F (type-N, 50 Ω), calibration: full 2-port

IF bandwidth = 10 Hz, No averaging applied to data, environmental temperature = 23°C ±5°C with < 1°C deviation from calibration temperature, isolation calibration not omitted

Description	Specification (dB)		
	3 MHz to 3 GHz	3 GHz to 6 GHz	6 GHz to 8.5 GHz
Directivity	49	40	38
Source match	41	36	35
Load match	49	40	37
Reflection tracking	±0.011	±0.032	±0.054
Transmission tracking	±0.016	±0.062	±0.088

Transmission uncertainty (specification)

Magnitude

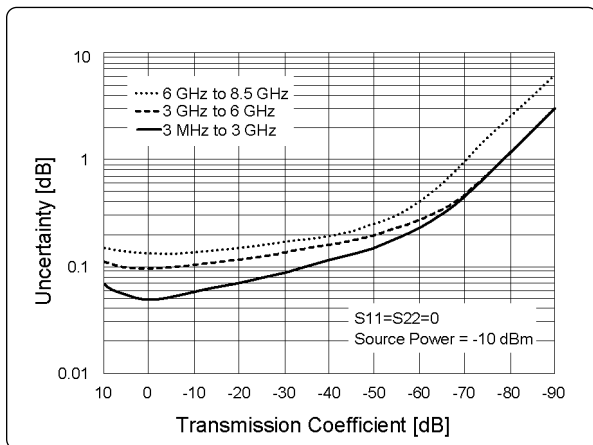

Phase

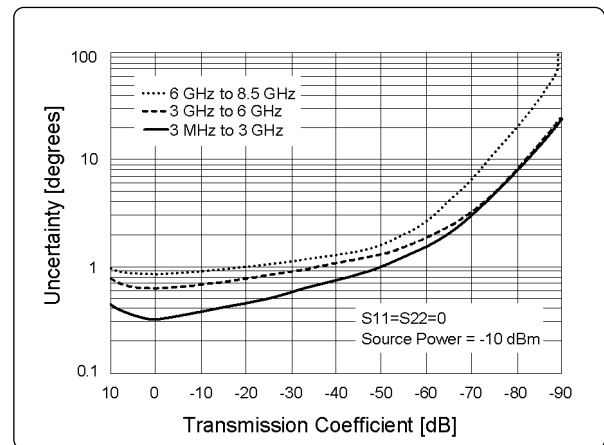

Reflection uncertainty (specification)

Magnitude

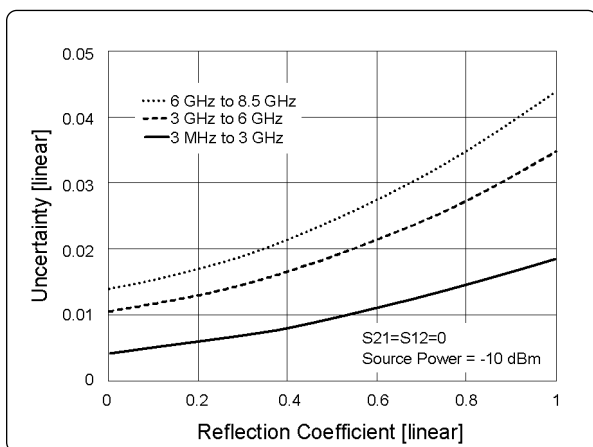

Phase

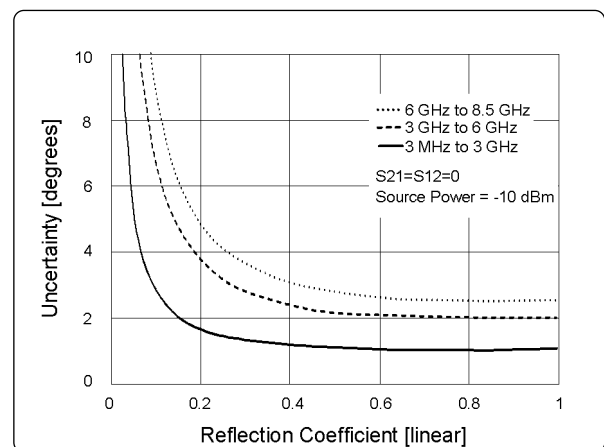

Table 1-3 Corrected system performance with type-N device connectors, 85092C electronic calibration module

Network analyzer: E5070B/E5071B, calibration module: 85092C (type-N, 50 Ω) electronic calibration (ECal) module, calibration: full 2-port

IF bandwidth = 10 Hz, no averaging applied to data, environmental temperature = 23°C ± 5°C with < 1°C deviation from calibration temperature, isolation calibration not omitted

Description	Specification (dB)		
	3 MHz to 3 GHz	3 GHz to 6 GHz	6 GHz to 8.5 GHz
Directivity	52	52	47
Source match	45	41	36
Load match	47	44	39
Reflection tracking	±0.040	±0.060	±0.070
Transmission tracking	±0.039	±0.069	±0.136

Transmission uncertainty (specification)

Magnitude

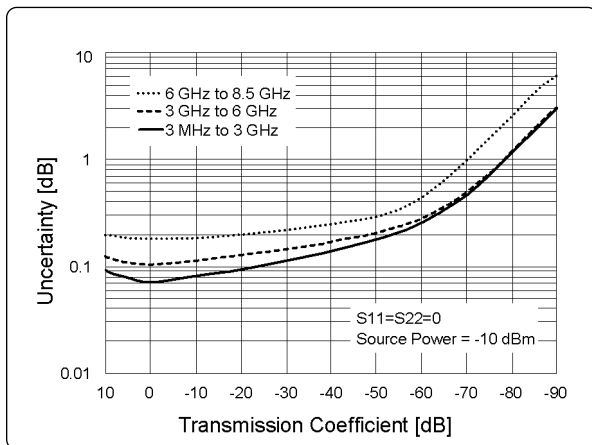

Phase

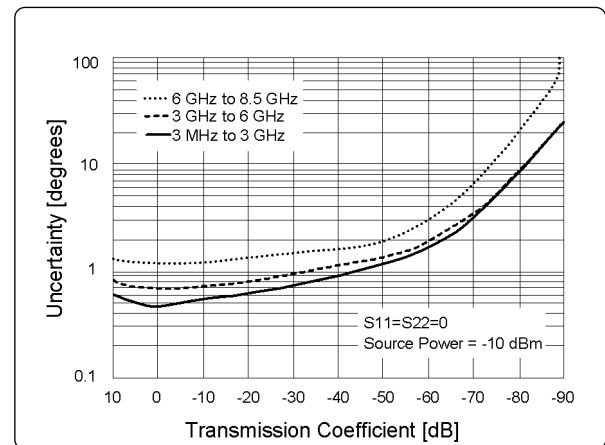

Reflection uncertainty (specification)

Magnitude

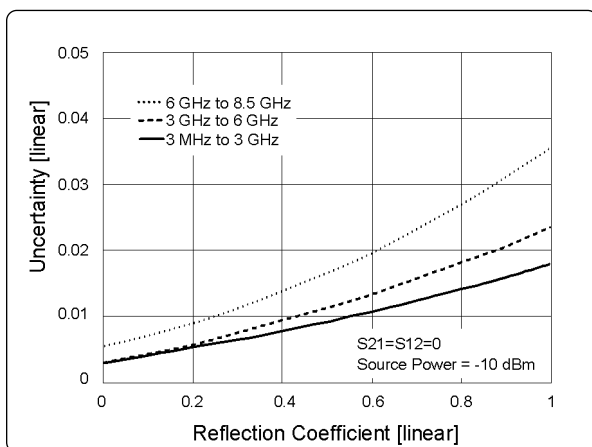

Phase

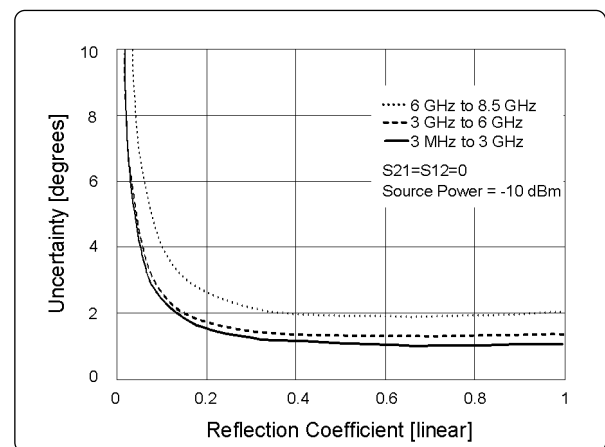

Table 1-4 Corrected system performance with 3.5 mm device connector type, 85033E calibration kit

Network analyzer: E5070B/E5071B, calibration kit: 85033E (3.5 mm, 50 Ω), calibration: full 2-port

IF bandwidth = 10 Hz, no averaging applied to data, environmental temperature = 23°C ± 5°C with < 1°C deviation from calibration temperature, isolation calibration not omitted

Description	Specification (dB)		
	3 MHz to 3 GHz	3 GHz to 6 GHz	6 GHz to 8.5 GHz
Directivity	46	38	38
Source match	43	37	36
Load match	46	38	38
Reflection tracking	±0.006	±0.009	±0.010
Transmission tracking	±0.016	±0.065	±0.079

Transmission uncertainty (specification)

Magnitude

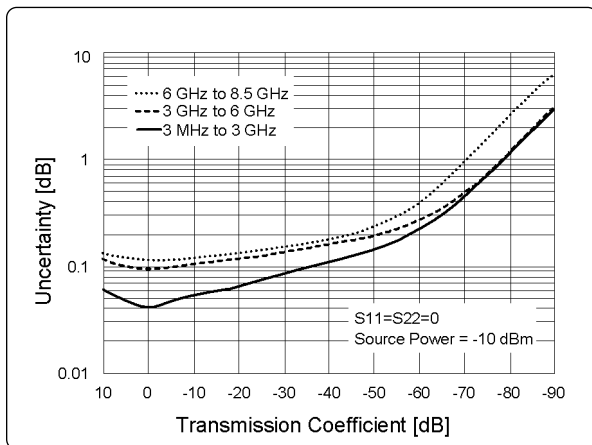

Phase

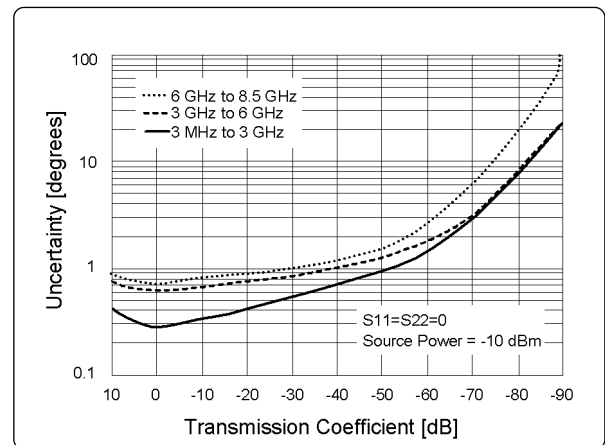

Reflection uncertainty (specification)

Magnitude

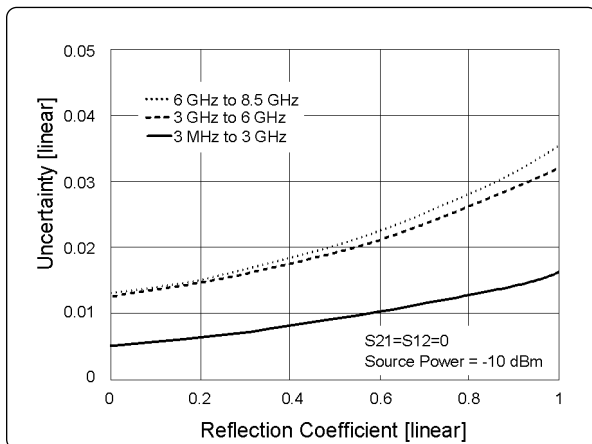

Phase

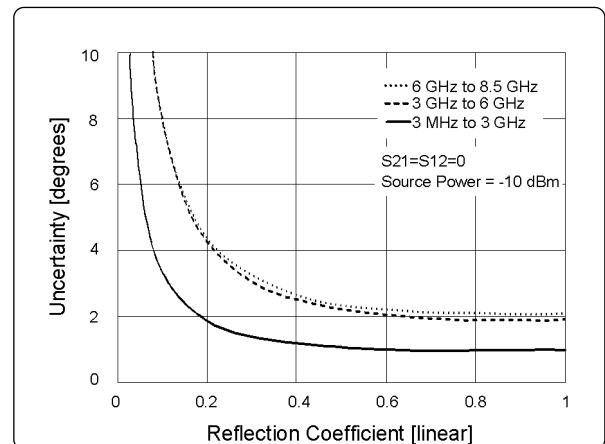

Table 1-5 Corrected system performance with 3.5 mm device connector type, 85093C electronic calibration module

Network analyzer: E5070B/E5071B, calibration module: 85093C (3.5 mm, 50 Ω) electronic calibration (ECal) module, calibration: full 2-port

IF bandwidth = 10 Hz, no averaging applied to data, environmental temperature = 23°C ± 5°C with < 1°C deviation from calibration temperature, isolation calibration not omitted

Description	Specification (dB)		
	3 MHz to 3 GHz	3 GHz to 6 GHz	6 GHz to 8.5 GHz
Directivity	52	51	47
Source match	44	39	34
Load match	47	44	40
Reflection tracking	±0.030	±0.050	±0.070
Transmission tracking	±0.039	±0.069	±0.117

Transmission uncertainty (specification)

Magnitude

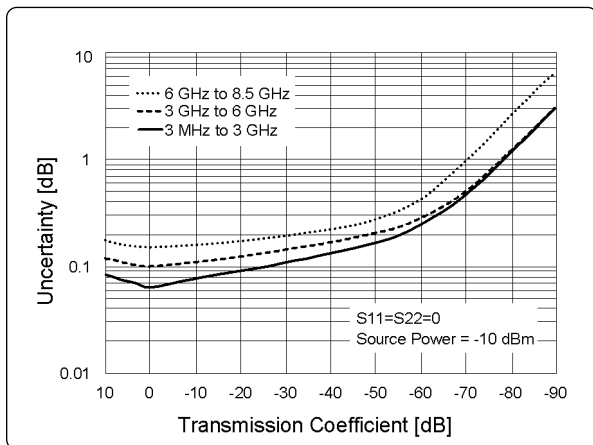

Phase

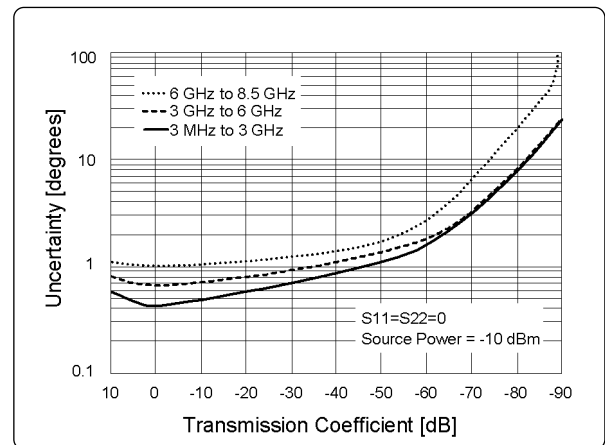

Reflection uncertainty (specification)

Magnitude

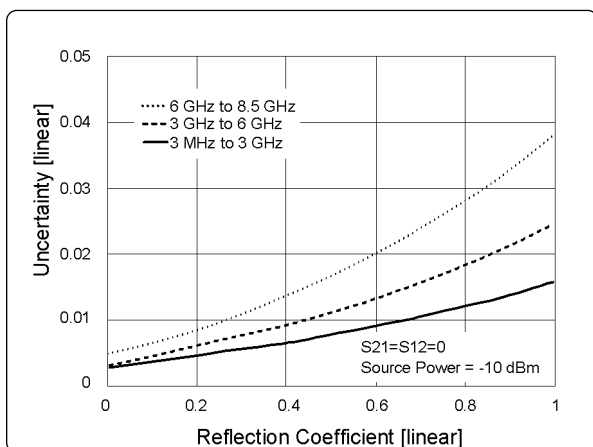

Phase

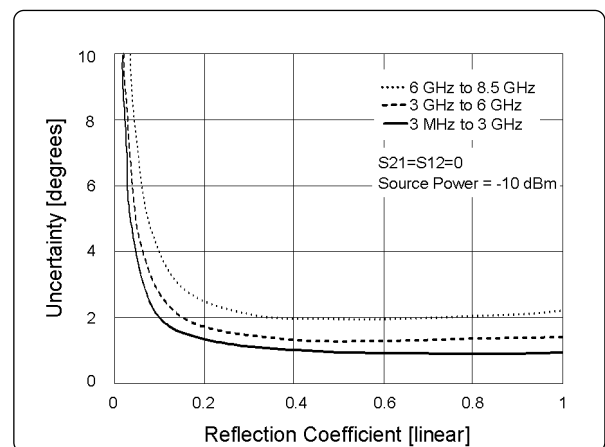

Uncorrected system performance

Table 1-6 **Uncorrected system performance (correction: off, system correction: on)**

Description	Specification		
	3 MHz to 3 GHz	3 GHz to 6 GHz	6 GHz to 8.5 GHz
Directivity	25 dB	20 dB	15 dB
Source match	25 dB	20 dB	15 dB
Load match	17 dB	12 dB	10 dB
Transmission tracking	±1.0 dB	±1.0 dB	±1.0 dB
Reflection tracking	±1.0 dB	±1.0 dB	±1.0 dB

Test port output (source)

Table 1-7 **Test port output frequency**

Description	Specification	Supplemental information
Range		
E5070B	300 kHz to 3 GHz	
E5071B	300 kHz to 8.5 GHz	
Resolution	1 Hz	
Source stability		
Option E5070B/E5071B-UNQ		±5 ppm (5°C to 40°C, typical)
Option E5070B/E5071B-1E5		±0.05 ppm (23°C ± 5°C, typical) ±0.5 ppm/year (typical)
CW accuracy		
Option E5070B/E5071B-UNQ	±5 ppm, 23°C ± 5°C	
Option E5070B/E5071B-1E5	±1 ppm, 23°C ± 5°C	

Test port output (source)

Table 1-8 Test port output power¹

Description	Specification	Supplemental information
Level accuracy (at 23°C ±5°C)		
300 kHz to 10 MHz		±1.0 dB (at 0 dBm, relative to 50 MHz reference)
10 MHz to 8.5 GHz	±0.650 dB (at 0 dBm, 50 MHz absolute, source attenuator 0 dB) ±1.0 dB (at 0 dBm, relative to 50 MHz reference, source attenuator 0 dB)	
Level accuracy (high temperature mode: on)		
300 kHz to 8.5 GHz		±0.8 dB (at 0 dBm, 50 MHz absolute, source attenuator 0 dB) ±1.5 dB (at 0 dBm, relative to 50 MHz reference, source attenuator 0 dB)
Level accuracy (swept mode: on)		
300 kHz to 4.25 GHz		±2.5 dB (at 0 dBm, relative to 50 MHz reference, source attenuator 0 dB)
4.25 GHz to 8.5 GHz		±3.5 dB (at 0 dBm, relative to 50 MHz reference, source attenuator 0 dB)
Level linearity (at 23°C ±5°C)		
10 MHz to 3 GHz	±0.75 dB (at -15 dBm to 10 dBm)	
3 GHz to 4.25 GHz	±0.75 dB (at -15 dBm to 9 dBm)	
4.25 GHz to 6 GHz	±0.75 dB (at -10 dBm to 7 dBm)	
6 GHz to 8.5 GHz	±0.75 dB (at -15 dBm to 5 dBm)	
Level linearity (high temperature mode: on)		
300 kHz to 3 GHz		±1.5 dB (at -15 dBm to 10 dBm)
3 GHz to 4.25 GHz		±1.5 dB (at -15 dBm to 9 dBm)
4.25 GHz to 6 GHz		±2.0 dB (at -15 dBm to 7 dBm)
6 GHz to 8.5 GHz		±2.0 dB (at -15 dBm to 5 dBm)
Level linearity (swept mode: on)		
300 kHz to 3 GHz		±1.5 dB (at -15 dBm to 10 dBm)
3 GHz to 4.25 GHz		±1.5 dB (at -15 dBm to 9 dBm)
4.25 GHz to 6 GHz		±3 dB (at -15 dBm to 7 dBm)
6 GHz to 8.5 GHz		±3 dB (at -15 dBm to 5 dBm)
Range (source attenuator 0 dB)		
300 kHz to 3 GHz	-15 dBm to 10 dBm	
3 GHz to 4.25 GHz	-15 dBm to 9 dBm	
4.25 GHz to 6 GHz	-15 dBm to 7 dBm	
6 GHz to 8.5 GHz	-15 dBm to 5 dBm	
Range (with source attenuators)		
300 kHz to 3 GHz		-50 dBm to 10 dBm (non-harmonics spurious may limit power range)
3 GHz to 4.25 GHz		-50 dBm to 9 dBm (non-harmonics spurious may limit power range)
4.25 GHz to 6 GHz		-50 dBm to 7 dBm (non-harmonics spurious may limit power range)
6 GHz to 8.5 GHz		-50 dBm to 5 dBm (non-harmonics spurious may limit power range)
Sweep range (source attenuator 0 dB)		
300 kHz to 3 GHz	-15 dBm to 10 dBm	-20 dBm to 10 dBm
3 GHz to 4.25 GHz	-15 dBm to 9 dBm	-20 dBm to 9 dBm
4.25 GHz to 6 GHz	-15 dBm to 7 dBm	-20 dBm to 7 dBm
6 GHz to 8.5 GHz	-15 dBm to 5 dBm	-20 dBm to 5 dBm
Level resolution	0.05 dB	

¹ Source output performance on port 1 only. Other port output performance is typical.

Test port output (source)

Table 1-9 Test port output signal purity

Description	Specification	Supplemental information
Harmonics (2nd or 3rd)		
10 MHz to 2 GHz		< -25 dBc (at 5 dBm, typical)
2 GHz to 3 GHz		< -15 dBc (at 5 dBm, typical)
3 GHz to 8.5 GHz		< -10 dBc (at 5 dBm, typical)
Non-harmonic spurious		
10 MHz to 3 GHz		< -25 dBc (at 5 dBm, typical)
3 GHz to 8.5 GHz		< -10 dBc (at 5 dBm, typical)

Test port input

Table 1-10 Test port input levels

Description	Specification	Supplemental information
Maximum test port input level		
300 kHz to 3 GHz	+10 dBm	
3 GHz to 4.25 GHz	+9 dBm	
3 GHz to 6 GHz	+7 dBm	
6 GHz to 8.5 GHz	+5 dBm	
Damage level		
300 kHz to 8.5 GHz		RF +20 dBm ±14 VDC (source attenuator = 0 dB) ±25 VDC (source attenuator = 5 dB or more, typical)
Crosstalk¹		
3 MHz to 3 GHz	-120 dB	
3 GHz to 6 GHz	-109 dB	
6 GHz to 7.5 GHz	-99 dB	
7.5 GHz to 8.5 GHz	-89 dB	

Table 1-11 Test port input (trace noise²)

Description	Specification	Supplemental information
Trace noise magnitude		
300 kHz to 3 MHz (source power level = +10 dBm)		5 mdB rms (typical) 8 mdB rms (high temperature mode: ON, typical)
3 MHz to 3 GHz (source power level = +10 dBm)	1 mdB rms (23°C ±5°C)	4 mdB rms (high temperature mode: ON, typical)
3 GHz to 4.25 GHz (source power level = +9 dBm)	1.2 mdB rms (23°C ±5°C)	4.8 mdB rms (high temperature mode: ON, typical)
4.25 GHz to 6 GHz (source power level = +7 dBm)	3.6 mdB rms (23°C ±5°C)	7.2 mdB rms (high temperature mode: ON, typical)
6 GHz to 7.5 GHz (source power level = +5 dBm)	3.6 mdB rms (23°C ±5°C)	7.2 mdB rms (high temperature mode: ON, typical)
7.5 GHz to 8.5 GHz (source power level = +5 dBm)	6 mdB rms (23°C ±5°C)	9.6 mdB rms (high temperature mode: ON, typical)
Trace noise phase		
300 kHz to 3 MHz (source power level = +10 dBm)		0.035° rms (23°C ±5°C, typical) 0.05° rms (high temperature mode: ON, typical)
3 MHz to 3 GHz (source power level = +10 dBm)		0.007° rms (23°C ±5°C, typical) 0.02° rms (high temperature mode: ON, typical)
3 GHz to 4.25 GHz (source power level = +9 dBm)		0.008° rms (23°C ±5°C, typical) 0.024° rms (high temperature mode: ON, typical)
4.25 GHz to 6 GHz (source power level = +7 dBm)		0.025° rms (23°C ±5°C, typical) 0.042° rms (high temperature mode: ON, typical)
6 GHz to 7.5 GHz (source power level = +5 dBm)		0.025° rms (23°C ±5°C, typical) 0.042° rms (high temperature mode: ON, typical)
7.5 GHz to 8.5 GHz (source power level = +5 dBm)		0.042° rms (23°C ±5°C, typical) 0.06° rms (high temperature mode: ON, typical)

¹ Response calibration not omitted.

² Trace noise is defined as a ratio measurement of a through, at IF bandwidth = 3 kHz.

Table 1-12 Test port input (stability¹)

Description	Specification	Supplemental information
Stability magnitude		
3 MHz to 3 GHz		0.005 dB/°C (at 23°C ±5°C, typical)
3 GHz to 6 GHz		0.01 dB/°C (at 23°C ±5°C, typical)
6 GHz to 8.5 GHz		0.04 dB/°C (at 23°C ±5°C, typical)
Stability phase		
3 MHz to 3 GHz		0.1°/°C (at 23°C ±5°C, typical)
3 GHz to 6 GHz		0.2°/°C (at 23°C ±5°C, typical)
6 GHz to 8.5 GHz		0.8°/°C (at 23°C ±5°C, typical)

Table 1-13 Test port input (dynamic accuracy)

Accuracy of the test port input power reading is relative to -10 dBm reference input power level.

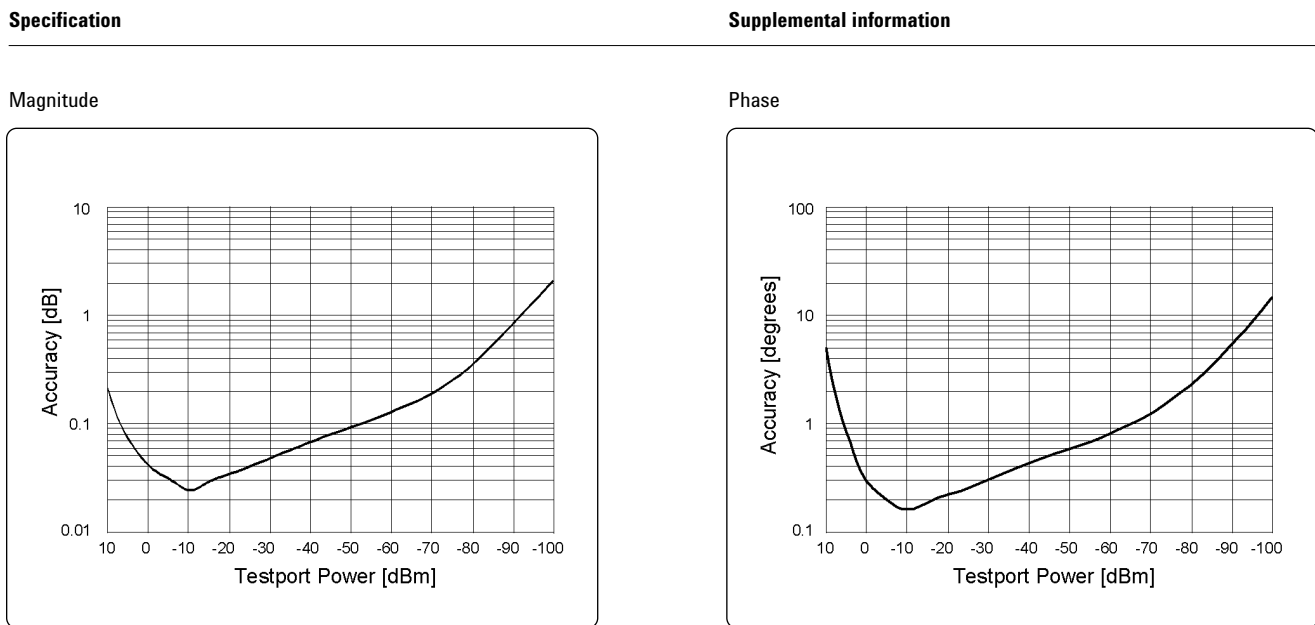

¹ Stability is defined as a ratio measurement at the test port.

Table 1-14 Test port input (group delay¹)

Description	Specification	Supplemental information
Aperture (selectable)	(frequency span)/(number of points -1)	
Maximum aperture	25% of frequency span	
Maximum delay		Limited to measuring no more than 180° of phase change within the minimum aperture.
Accuracy		See graph below, typical

The following graph shows group delay accuracy with type-N full 2-port calibration and a 10 Hz IF bandwidth. Insertion loss is assumed to be < 2 dB.

Group delay (typical)

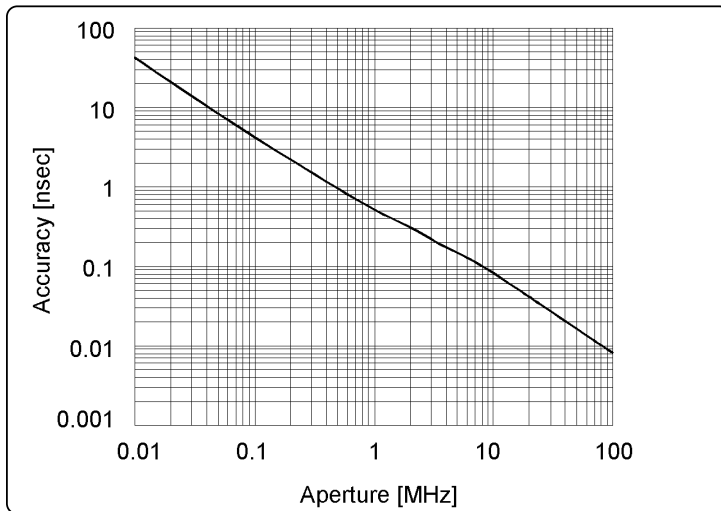

In general, the following formula can be used to determine the accuracy, in seconds, of specific group delay measurement:
 $\pm \text{phase accuracy (deg)}/[360 \times \text{aperture (Hz)}]$

¹ Group delay is computed by measuring the phase change within a specified step (determined by the frequency span and the number of points per sweep).

General information

Table 1-15

System bandwidths

Description	Supplemental information
IF bandwidth settings	
Range	10 Hz to 100 kHz Nominal settings are: 10, 15, 20, 30, 40, 50, 70, 100, 150, 200, 300, 400, 500, 700, 1 k, 1.5 k, 2 k, 3 k, 4 k, 5 k, 7 k, 10 k, 15 k, 20 k, 30 k, 40 k, 50 k, 70 k, 100 kHz

Table 1-16

Front panel information

Description	Supplemental information
RF connectors	
Type	Type-N, female; 50 Ω , nominal
Display	
Size	10.4 in TFT color LCD
Resolution	VGA (640x480)

Table 1-17**Rear panel information**

Description	Supplemental information
External trigger connector	
Type	BNC, female
Input level	LOW threshold voltage: 0.5 V HIGH threshold voltage: 2.1 V Input level range: 0 to +5 V
Pulse width	$\geq 2 \mu\text{sec}$, typical
Polarity	Negative (downward) only
External reference signal input connector	
Type	BNC, female
Input frequency	10 MHz ± 10 ppm, typical
Input level	0 dBm ± 3 dB, typical
Internal reference signal output connector	
Type	BNC, female
Output frequency	10 MHz ± 10 ppm, typical
Signal type	Sine wave, typical
Output level	0 dBm ± 3 dB into 50 Ω , typical
Output impedance	50 Ω , nominal
VGA video output	15-pin mini D-Sub; female; drives VGA compatible monitors
 GPIB	24-pin D-Sub (type D-24), female; compatible with IEEE-488
Parallel port	36-pin D-Sub (type 1284-C), female; provides connection to printers
USB port	Universal serial bus jack, type A configuration (4 contacts inline, contact 1 on left); female; provides connection to printer, ECal module, USB/GPIB interface or multiport test set
Contact 1	Vcc: 4.75 to 5.25 VDC, 500 mA, maximum
Contact 2	-Data
Contact 3	+Data
Contact 4	Ground
LAN	10/100 BaseT Ethernet, 8-pin configuration; auto selects between the two data rates
Handler I/O port	36-pin D-sub, female; provides connection to handler system
Line power¹	
Frequency	47 Hz to 63 Hz
Voltage	90 to 132 VAC, or 198 to 264 VAC (automatically switched)
VA max	350 VA max.

¹ A third-wire ground is required.

Table 1-18

EMC and safety





Description	Supplemental information
EMC	
	European Council Directive 89/336/EEC EN / IEC 61326-1:1997+A1:1998 CISPR 11:1997+A1:1999 / EN 55011:1998+A1:1999 Group 1, Class A IEC 61000-4-2:1995 / EN 61000-4-2:1995+A1:1998 4 kV CD / 4 kV AD IEC 61000-4-3:1995 / EN 61000-4-3:1996+A1:1998 3 V/m, 80-1000 MHz, 80% AM IEC 61000-4-4:1995 / EN 61000-4-4:1995 1 kV power / 0.5 kV Signal IEC 61000-4-5:1995 / EN 61000-4-5:1995 0.5 kV Normal / 1 kV Common IEC 61000-4-6:1996 / EN 61000-4-6:1996 3 V, 0.15-80 MHz, 80% AM IEC 61000-4-11:1994 / EN 61000-4-11:1994 100% 1cycle
ICES/NMB-001	Canada ICES001:1998 Note: The performance of EUT will be within the specification over the RF immunity tests according to EN 61000-4-3 or EN 61000-4-6 except under the coincidence of measurement frequency and interference frequency.
	AS/NZS 2064.1/2 Group 1, Class A
Safety	
	European Council Directive 73/23/EEC IEC 61010-1:1990+A1+A2 / EN 61010-1:1993+A2 INSTALLATION CATEGORY II, POLLUTION DEGREE 2 INDOOR USE IEC60825-1:1994 CLASS 1 LED PRODUCT
	CAN/CSA C22.2 No. 1010.1-92

Table 1-19

Analyzer environment and dimensions

Description	Supplemental information
Operating environment	
Temperature	+5°C to +40°C
Error-corrected temperature range	23°C ± 5°C with < 1°C deviation from calibration temperature
Humidity	20% to 80% at wet bulb temperature < +29°C (non-condensing)
Altitude	0 to 2,000 m (0 to 6,561 feet)
Vibration	0.5 G maximum, 5 Hz to 500 Hz
Non-operating storage environment	
Temperature	-10°C to +60°C
Humidity	20% to 90% at wet bulb temperature < 40°C (non-condensing)
Altitude	0 to 4,572 m (0 to 15,000 feet)
Vibration	0.5 G maximum, 5 Hz to 500 Hz
Dimensions	
	See figure 1-1 through figure 1-3.
Weight	
Net	17.5 kg (option E5070B/E5071B-214, nominal) 19.5 kg (option E5070B/E5071B-414, nominal)

Figure 1-1. Dimensions (front view, E5071B with option E5071B-414, in millimeters, nominal)

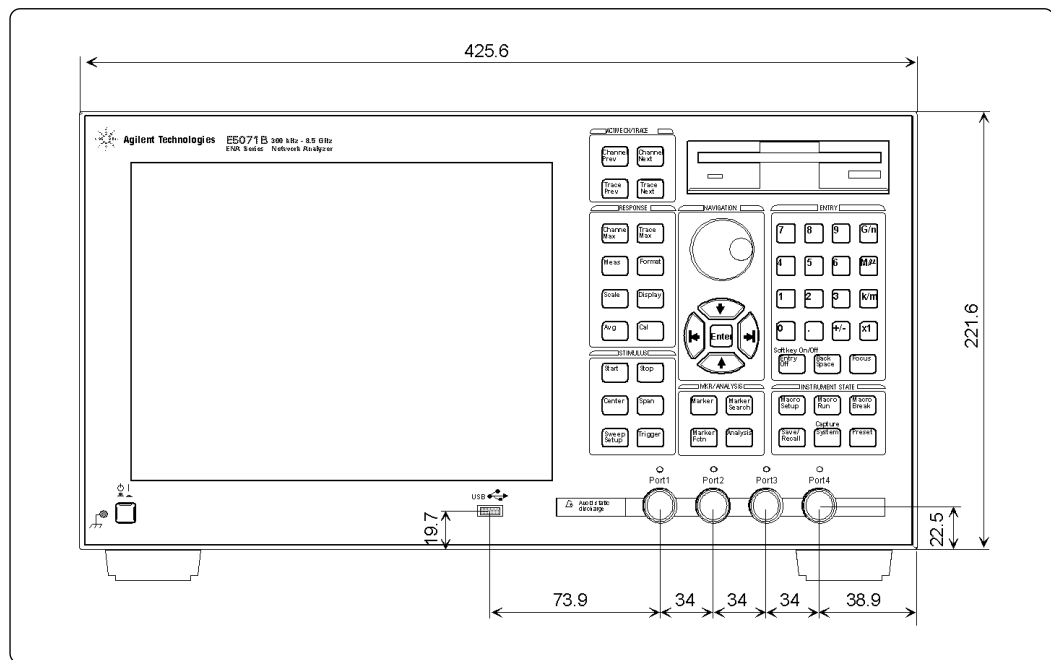

Figure 1-2. Dimensions (rear view, with option E5070B/E5071B-1E5, in millimeters, nominal)

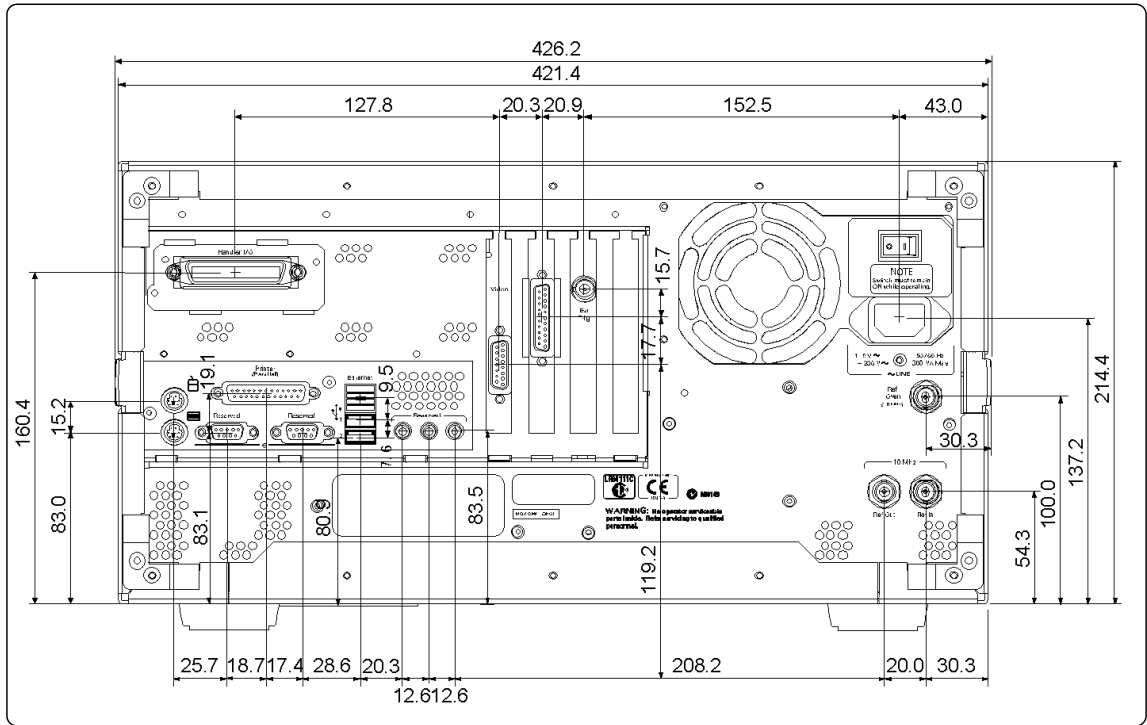
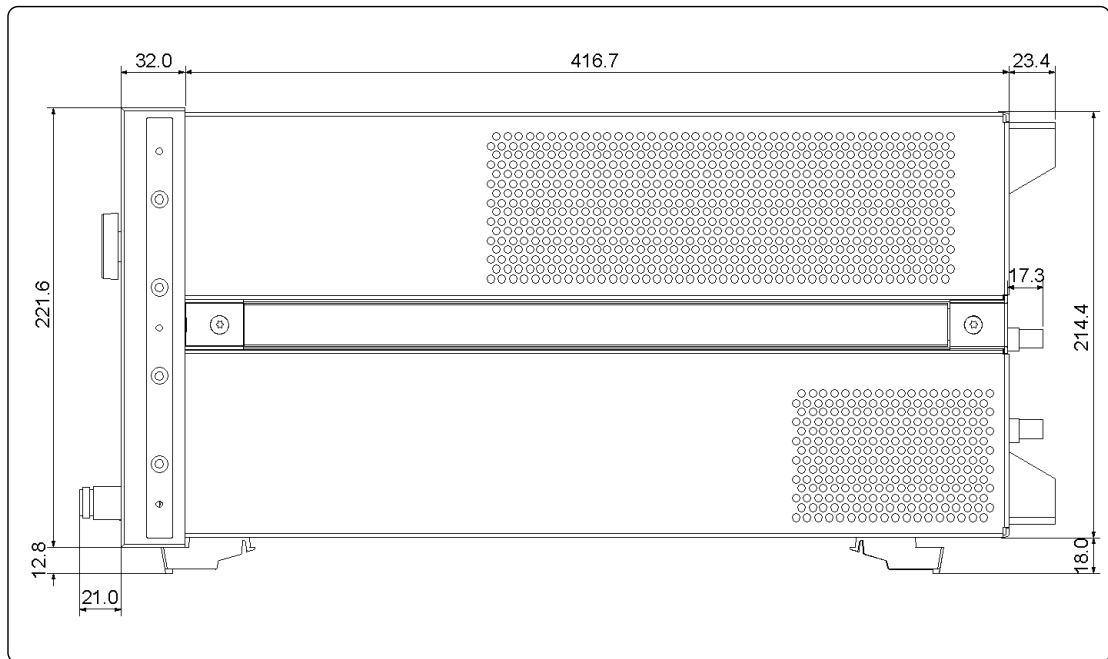

Figure 1-3. Dimensions (side view, in millimeters, nominal)



Measurement throughput summary

Table 1-20 Typical cycle time for measurement completion^{1,2} (ms)

	Number of points			
	51	201	401	1601
Start 1 GHz, stop 1.2 GHz, 100 kHz IF bandwidth				
Uncorrected	4	5	7	18
2-port cal	5	8	13	42
Start 300 kHz, stop 3 GHz, 100 kHz IF bandwidth				
Uncorrected	11	12	13	23
2-port cal	20	23	25	46
Start 300 kHz, stop 8.5 GHz, 100 kHz IF bandwidth				
Uncorrected	19	24	24	24
2-port cal	37	46	48	50

Table 1-21 Typical cycle time for measurement completion^{1,3} (ms)

	Number of points			
	51	201	401	1601
Start 1 GHz, Stop 1.2 GHz, 100 kHz IF bandwidth				
Uncorrected	4	6	8	22
2-port cal	5	10	16	56
Start 300 kHz, Stop 3 GHz, 100 kHz IF bandwidth				
Uncorrected	11	12	13	23
2-port cal	20	24	25	55
Start 300 kHz, Stop 8.5 GHz, 100 kHz IF bandwidth				
Uncorrected	20	24	24	26
2-port cal	37	46	47	57

Table 1-22 Typical cycle time for measurement completion^{1,4} (ms)

	Number of points			
	51	201	401	1601
Start 1 GHz, Stop 1.2 GHz, 100 kHz IF bandwidth				
Uncorrected	7	17	29	90
2-port cal	12	32	55	178
Start 300 kHz, Stop 3 GHz, 100 kHz IF bandwidth				
Uncorrected	14	27	43	130
2-port cal	26	50	84	258
Start 300 kHz, Stop 8.5 GHz, 100 kHz IF bandwidth				
Uncorrected	16	30	49	146
2-port cal	30	57	96	291

¹ Typical performance.

² Fast swept mode. System error correction OFF. Analyzer display turned off with :DISP:ENAB OFF. Number of traces = 1.

³ Fast swept mode. System error correction ON. Analyzer display turned off with :DISP:ENAB OFF. Number of traces = 1.

⁴ Standard stepped mode. System error correction ON. Analyzer display turned off with :DISP:ENAB OFF. Number of traces = 1.

Table 1-23**Cycle time^{1,2} (ms) vs. number of points¹**

Number of points	Fast swept mode system error correction OFF	Fast swept mode system error correction ON	Standard stepped mode system error correction ON
3	4	4	4
11	4	4	4
51	4	4	7
101	4	5	11
201	5	6	17
401	8	8	29
801	11	13	52
1601	18	23	90

Table 1-24**Data transfer time¹ (ms)**

Number of points	51	201	401	1601
SCPI over GPIB³				
64-bit floating point	5	16	29	109
ASCII	21	79	156	617
SCPI over 100 Mbps LAN (telnet)³				
REAL 64	2	2	3	5
ASCII	34	128	254	995
SCPI over 100 Mbps LAN (SICL-LAN)³				
REAL 64	4	4	5	8
ASCII	6	14	26	95
COM (program executed in the analyzer)⁴				
Variant type	1	1	1	1

¹ Typical performance.² Start 1 GHz, stop 1.2 GHz, 100 kHz IF bandwidth, Error correction OFF, display update: OFF, number of traces = 1.³ Measured using a VEE 6.0 program running on a 733 MHz Pentium III HP Kayak, Transferred complex S₁₁ data, using :CALC:DATA?SDATA.⁴ Measured using an E5070B/E5071B VBA macro running inside the analyzer. Transferred complex S₁₁ data.

Measurement capabilities

Number of measurement channels	Up to 16 independent measurement channels. A measurement channel is coupled to stimulus response settings including frequency, IF bandwidth, power level, and number of points.
Number of display windows	Each measurement channel has a display window. Up to 16 display windows (channels) can be displayed.
Number of traces	Four display modes (selectable): 16 data traces and 16 memory traces per channel at 4-channel mode 9 data traces and 9 memory traces per channel at 9-channel mode 6 data traces and 6 memory traces per channel at 12-channel mode 4 data traces and 4 memory traces per channel at 16-channel mode
Measurement choices	Option E5070B/E5071B-214: $S_{11}, S_{21}, S_{12}, S_{22}$ Option E5070B/E5071B-314: $S_{11}, S_{21}, S_{31}, S_{12}, S_{22}, S_{32}, S_{13}, S_{23}, S_{33}$ Mixed-mode S-parameters, balanced parameters, CMRR Option E5070B/E5071B-414: $S_{11}, S_{21}, S_{31}, S_{41}, S_{12}, S_{22}, S_{32}, S_{42}, S_{13}, S_{23}, S_{33}, S_{43}, S_{14}, S_{24}, S_{34}, S_{44}$, mixed mode S-parameters, balanced parameters, CMRR Option E5070B/E5071B-214 and 008: $S_{11}, S_{21}, S_{12}, S_{22}$, absolute parameters. Option E5070B/E5071B-314 and 008: $S_{11}, S_{21}, S_{31}, S_{12}, S_{22}, S_{32}, S_{13}, S_{23}, S_{33}$, Mixed-mode S-parameters, balanced parameters, CMRR, absolute parameters. Option E5070B/E5071B-414 and 008: $S_{11}, S_{21}, S_{31}, S_{41}, S_{12}, S_{22}, S_{32}, S_{42}, S_{13}, S_{23}, S_{33}, S_{43}, S_{14}, S_{24}, S_{34}, S_{44}$, mixed mode S-parameters, balanced parameters, CMRR, absolute parameters.
Measurement parameter conversion	Available to convert S-parameters into reflection impedance, transmission impedance (series), transmission impedance (shunt), reflection admittance, transmission admittance (series), transmission admittance (shunt), and 1/S.
Data formats	Log magnitude, linear magnitude, phase, extended phase, positive phase, group delay, SWR, real, imaginary, Smith chart, polar.
Data markers	10 independent markers per trace. Reference marker available for delta marker operation. Smith chart format includes 5 marker formats: linear magnitude/phase, log magnitude/phase, real/imaginary, $R + jX$, and $G + jB$. Polar chart format includes 3 marker formats: linear magnitude/phase, log magnitude/phase, and real/imaginary.
Marker functions	
Marker search	Max value, min value, peak, peak left, peak right, target, target left, target right, bandwidth parameters with user-defined bandwidth values.
Marker-to functions	Set start, stop, center to active marker stimulus value; set reference to active marker response value; set electrical delay to group delay at active marker.
Search range	User definable.
Tracking	Performs marker search continuously or on demand.
Time domain functions¹	
Transformation	Selectable transformation type from bandpass, lowpass impulse, lowpass step. Selectable window from maximum, normal and minimum.
Gated functions	Selectable gated filter type from bandpass, notch. Selectable gate shape from maximum, normal and wide.

¹ Option E5070B-010 or E5071B-010 is required.

Source control

Measured number of points per sweep	User definable from 2 to 1601.
Sweep mode	Standard stepped, standard swept, fast stepped and fast swept.
Sweep type	Linear sweep, segment sweep, log sweep and power sweep.
Segment sweep	Define independent sweep segments. Set number of points, test port power levels, IF bandwidth, delay time, sweep time and sweep mode independently for each segment.
Sweep trigger	Set to continuous, hold, or single, sweep with internal, external, manual, or bus trigger.
Trigger event	Set trigger event dependent on sweep or data point.
Power	Set source power from -50 dBm to 10 dBm. The power slope function and the power calibration function compensate source power level error.
Frequency-offset¹	Set source frequency independently from where the receivers are tuned.

Trace functions

Display data	Display current measurement data, memory data, or current measurement and memory data simultaneously.
Trace math	Vector addition, subtraction, multiplication or division of measured complex values and memory data.
Title	Add custom title to each channel window. Titles are printed on hardcopies of displayed measurements.
Autoscale	Automatically selects scale resolution and reference value to vertically center the trace.
Electrical delay	Offset measured phase or group delay by a defined amount of electrical delay, in seconds.
Phase offset	Offset measured phase or group delay by a defined amount in degrees.
Statistics	Calculates and displays mean, standard deviation and peak-to-peak deviation of the data trace.

¹ Option E5070B-008 or E5071B-008 is required.

Data accuracy enhancement

Measurement calibration	Measurement calibration significantly reduces measurement uncertainty due to errors caused by system directivity, source and load match, tracking and crosstalk. Full 2-port, 3-port, or 4-port calibration removes all the systematic errors for the related test ports to obtain the most accurate measurements.
Calibration types available	
Response	Simultaneous magnitude and phase correction of frequency response errors for either reflection or transmission measurements.
Response and isolation	Compensates for frequency response and crosstalk errors of transmission measurements.
One-port calibration	Available on test set port 1, port 2, port 3, or port 4 to correct for directivity, frequency response and source match errors.
Full 2-port/3-port/4-port calibration TRL/LRM calibration	Compensates for directivity, source match, reflection tracking, load match, transmission tracking and crosstalk. Crosstalk calibration can be omitted.
Interpolated error correction	With any type of accuracy enhancement applied, interpolated mode recalculates the error coefficients when the test frequencies are changed. The number of points can be increased or decreased and the start/stop frequencies can be changed.
Velocity factor	Enter the velocity factor to calculate the equivalent physical length.
Reference port extension	Redefine the measurement plane from the plane where the calibration was done.
Mixer calibration	
Scalar-mixer calibration	Scalar-mixer calibration corrects the conversion loss for input port source match and output port load match. Scalar-mixer calibration also corrects the input match measurements for input port directivity, frequency response, and source match at the input frequencies and corrects the output match measurements for output port directivity, frequency response, and source match at output frequencies. This calibration offers the conversion loss/gain measurements with correcting the mismatches of both input and output test ports.
Vector-mixer calibration	Vector-mixer calibration corrects for directivity, source match, load match, and reflection frequency response at each test port by using a characterized calibration mixer with de-embedding function. This calibration provides the measurements of phase and absolute group delay. The characterization of the calibration mixer is part of the calibration process.

Storage

Internal hard disk drive	Store and recall instrument states, calibration data, and trace data on 3 GB, minimum, internal hard drive. Trace data can be saved in CSV (comma separated value) format. All files are MS-DOS [®] -compatible. Instrument states include all control settings, limit lines, segment sweep tables, and memory trace data.
File sharing	Internal hard disk drive (D:) can be accessed from an external Windows [®] PC through LAN.
Disk drive	Instrument states, calibration data, and trace data can be stored on an internal 3.5 inch 1.4 MB floppy disk in MS-DOS [®] -compatible format.
Screen hardcopy	Printouts of instrument data are directly produced on a printer. The analyzer provides USB and parallel interfaces.

System capabilities

Familiar graphical user interface	The ENA Series analyzer employs a graphical user interface based on Windows® operating system. There are three ways to operate the instrument manually: you can use a hardkey interface, touch screen interface (option E5070B/E5071B-016) or a mouse interface.
Limit lines	Define the test limit lines that appear on the display for pass/fail testing. Defined limits may be any combination of horizontal/sloping lines and discrete data points.
Fixture simulator	
Balance-unbalance conversion	Convert data from single-ended measurement to balanced measurement parameters (mixed-mode S-parameters), balanced parameters or CMRR by using internal software.
Network de-embedding	De-embed an arbitrary circuit defined by a two-port Touchstone data file (50 Ω system) for each test port. This function eliminates error factors between calibration plane and DUT and expands the calibration plane for each test port. This function can be used with the port extension function.
Port reference impedance conversion	Convert S-parameters measured in 50 Ω reference impedance to data in other reference impedance levels by using internal software. This conversion can be performed for both single-ended (unbalance) measurement ports and converted balanced measurement ports.
Matching circuit	Add one of predefined matching circuits or a circuit defined by a two-port Touchstone data file to each single-ended test port or converted balanced (differential) test port by using internal software.

Automation

	 GPIB 	 Internal
SCPI	X	X
COM		X

Methods

Internal analyzer execution	Applications can be developed in a built-in VBA® (Visual Basic for Applications) language. Applications can be executed from within the analyzer via COM (component object model) or using SCPI.
Controlling via GPIB	The GPIB interface operates to IEEE 488.2 and SCPI protocols. The analyzer can be controlled by a GPIB external controller. The analyzer can control external devices using a USB/GPIB interface.

LAN

Standard conformity	10 BaseT or 100 BaseTX (automatically switched), Ethertwist, RJ45 connector
Protocol	TCP/IP
Function	Telnet, SICL-LAN

E5091A multiport test set

The section provides test set input/output performance without calibration by the E5070B/E5071B.

Table 2-1 Test set input/output performance

Description	Specification	Supplemental information
Range	50 MHz to 8.5 GHz	
Damage level		20 dBm, ± 25 VDC (typical)

Table 2-2 Option E5091A-007 port performance

Description	Specification				
	50 MHz to 300 MHz	300 MHz to 1.3 GHz	1.3 GHz to 3 GHz	3 GHz to 6 GHz	6 GHz to 8.5 GHz
Load match					
Test port selected					
A, T2, R1+, R1-, R2+, R2-	19 dB	20 dB	18 dB	12 dB	10 dB
T1	15 dB	17 dB	15 dB	11 dB	8 dB
Test port unselected					
A, T2, R1+, R1-, R2+, R2-	23 dB	25 dB	19 dB	12 dB	11 dB
T1	18 dB	20 dB	16 dB	12 dB	9 dB
Interconnect port, typical					
P1, P2, P3, P4	19 dB	19 dB	17 dB	13 dB	9 dB
Insertion loss					
Test port					
A, T2, R1+, R1-, R2+, R2-	3 dB	3 dB	4 dB	5 dB	6 dB
T1	5 dB	5 dB	7 dB	8 dB	9.5 dB
Stability, typical	0.005 dB/°C	0.005 dB/°C	0.005 dB/°C	0.01 dB/°C	0.015 dB/°C
Isolation					
Over arbitrarily test ports	-100 dB	-100 dB	-100 dB	-100 dB	-90 dB

Table 2-3**Option E5091A-009 port performance**

Description	Specification				
	50 MHz to 300 MHz	300 MHz to 1.3 GHz	1.3 GHz to 3 GHz	3 GHz to 6 GHz	6 GHz to 8.5 GHz
Load match					
Test port selected					
A, T2, R1+, R1–	19 dB	20 dB	18 dB	12 dB	10 dB
T1, R2+, R2–, R3+, R3–	15 dB	17 dB	15 dB	11 dB	8 dB
Test port unselected					
A, T2, R1+, R1–, R3+, R3–	23 dB	25 dB	19 dB	12 dB	11 dB
T1, R2+, R2–	18 dB	20 dB	16 dB	12 dB	9 dB
Interconnect port, typical					
P1, P2, P3, P4	19 dB	19 dB	17 dB	13 dB	9 dB
Insertion loss					
Test port					
A, T2, R1+, R1–	3 dB	3 dB	4 dB	5 dB	6 dB
T1, R2+, R2–, R3+, R3–	5 dB	5 dB	7 dB	8 dB	9.5 dB
Stability, typical	0.005 dB/°C	0.005 dB/°C	0.005 dB/°C	0.01 dB/°C	0.015 dB/°C
Isolation					
Over arbitrarily test ports	-100 dB	-100 dB	-100 dB	-100 dB	-90 dB

Table 2-4**Front panel information**

Description	Supplemental information
RF connectors	
Type	Type-N, female, 50 Ω, nominal
Number of ports	Option E5091A-007: 11 (4 interconnect ports, 7 test ports) Option E5091A-009: 13 (4 interconnect ports, 9 test ports)
Control line	15 pin D-sub, female

Table 2-5**Rear panel information**

Description	Supplemental information
USB port	Type B-receptacles, provide connection to the E5070B/E5071B
Line power¹	
Frequency	47 Hz to 63 Hz
Voltage	90 to 132 VAC, or 198 to 264 VAC (automatically switched)
VA max	70 VA max.

For EMC, safety and environment information, refer to E5070B/E5071B section.

¹ A third-wire ground is required.

Table 2-6 Test set dimensions and block diagram

Description	Supplemental information
Dimensions	See figure 2-1 through figure 2-3.
Weight	
Net	6 kg (option E5091A-007/009, nominal)
Block diagram	See figure 2-4

Figure 2-1. Dimensions (front view, with option E5091A-009, in millimeters, nominal)

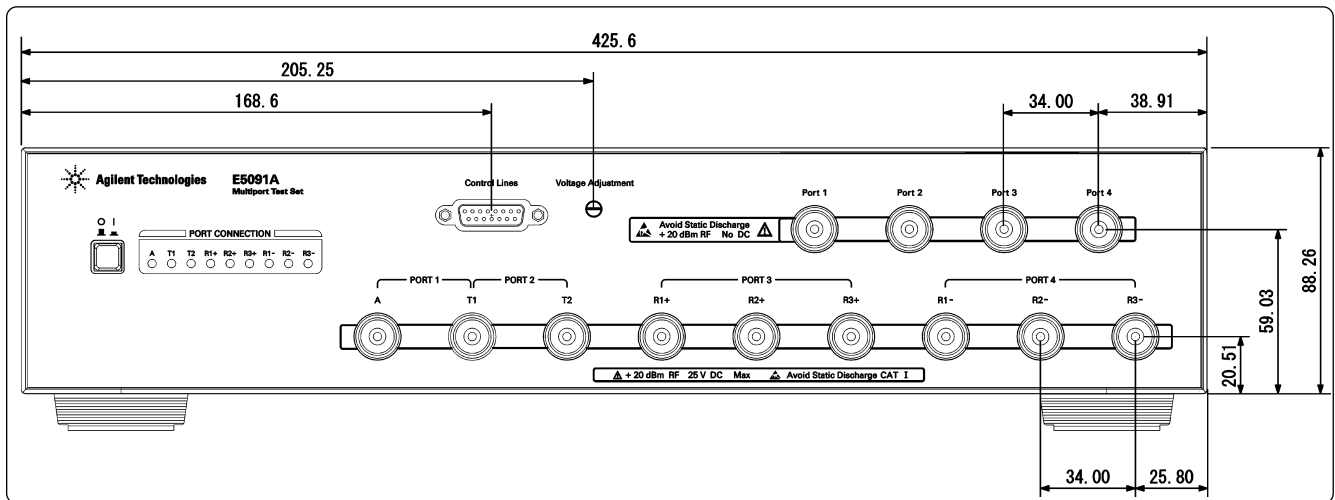

Figure 2-2. Dimensions (rear view, in millimeters, nominal)

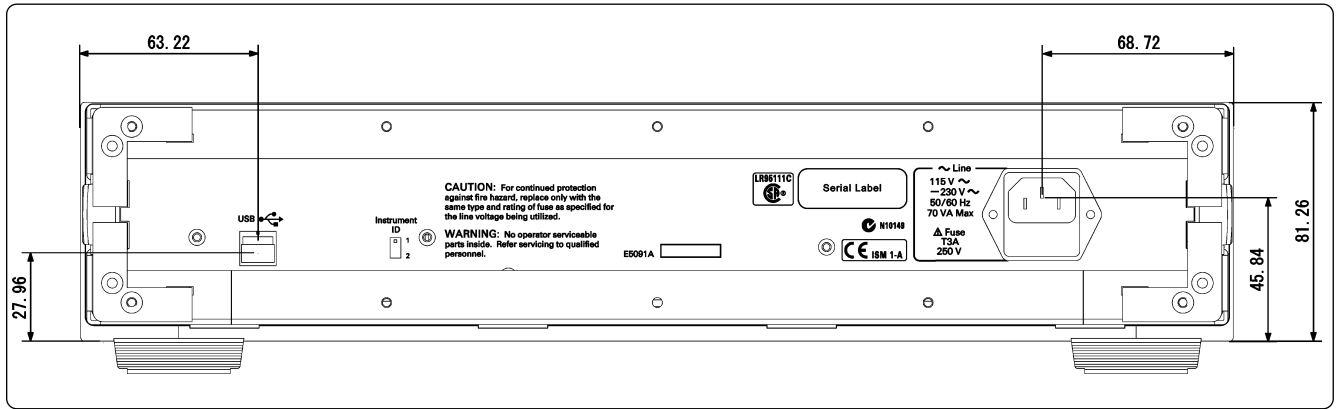

Figure 2-3. Dimensions (side view, in millimeters, nominal)

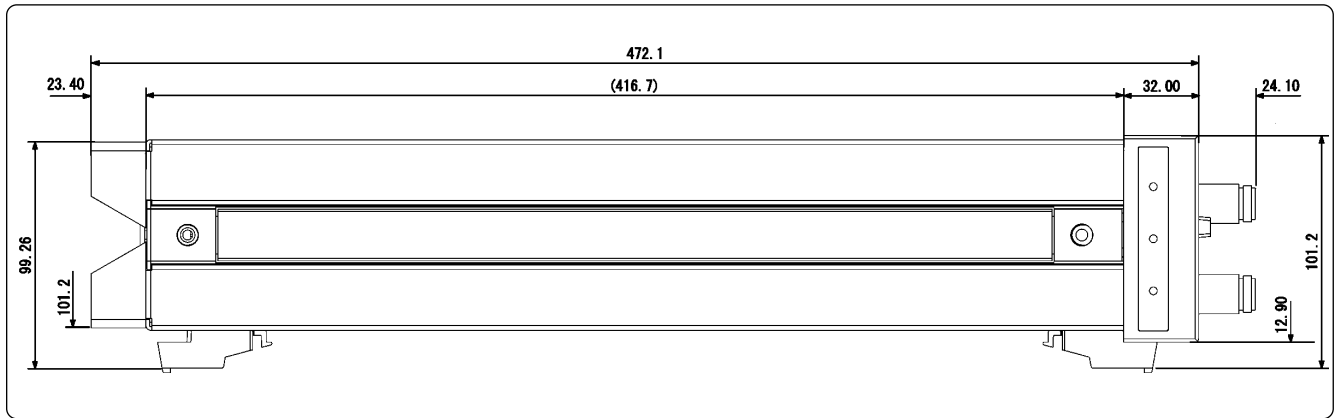
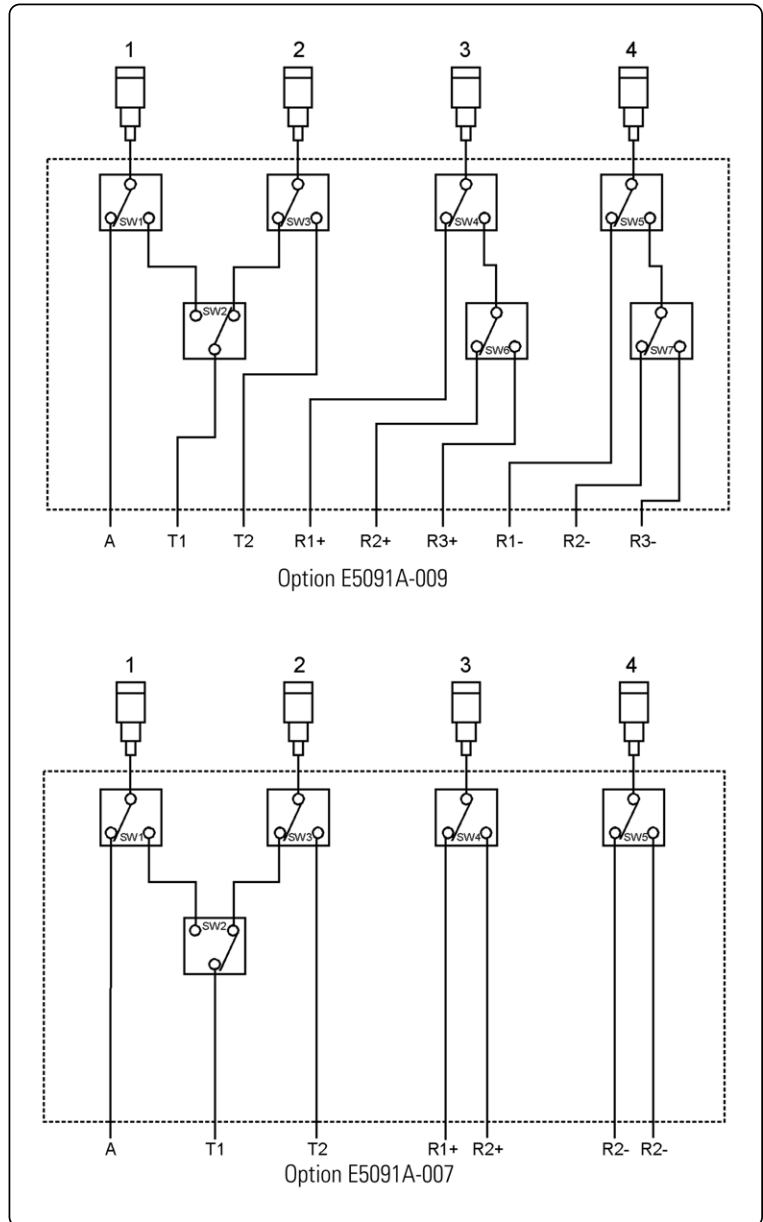

Figure 2-4. Block diagram



Corrected system performance for 75 Ω measurements with 11852B 50 Ω to 75 Ω minimum-loss pads (supplemental information)

Table 3-1 Corrected system performance with type-N 75 Ω device connectors, 85036E calibration kit

Network analyzer: E5070B/E5071B, calibration kit: 85036E (type-N 75 Ω), 50 Ω to 75 Ω adapters: 11852B, calibration: full 2-port

IF bandwidth = 10 Hz, no averaging applied to data, environmental temperature = 23°C ± 5°C with < 1°C deviation from calibration temperature, Isolation calibration not omitted

Description	Supplemental information (dB, typical)
	3 MHz to 3 GHz
Directivity	37
Source match	33
Load match	37
Reflection tracking	±0.017
Transmission tracking	±0.021

Transmission uncertainty 3 MHz to 3 GHz (supplemental information, typical)

Magnitude

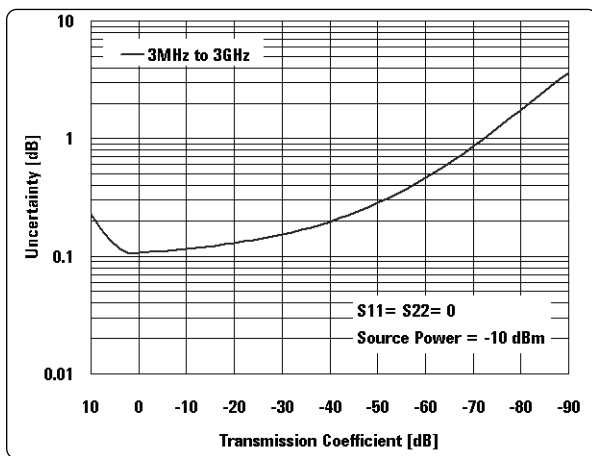

Phase

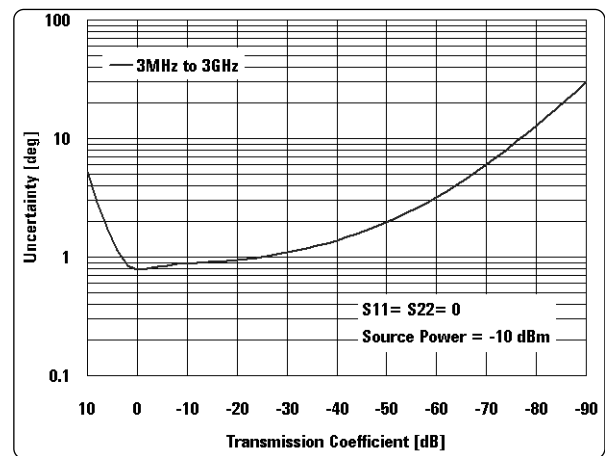

Reflection uncertainty 3 MHz to 3 GHz (supplemental information, typical)

Magnitude

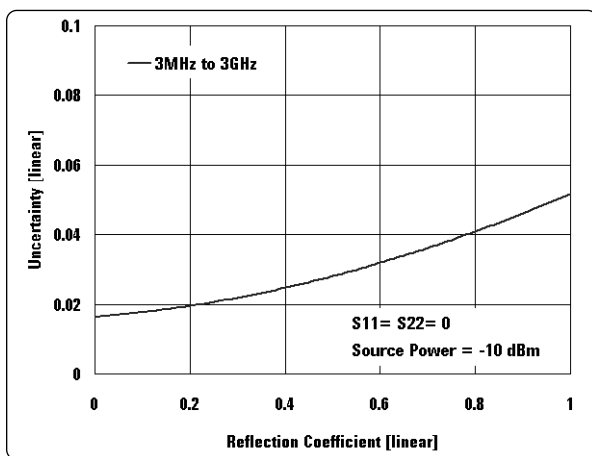

Phase

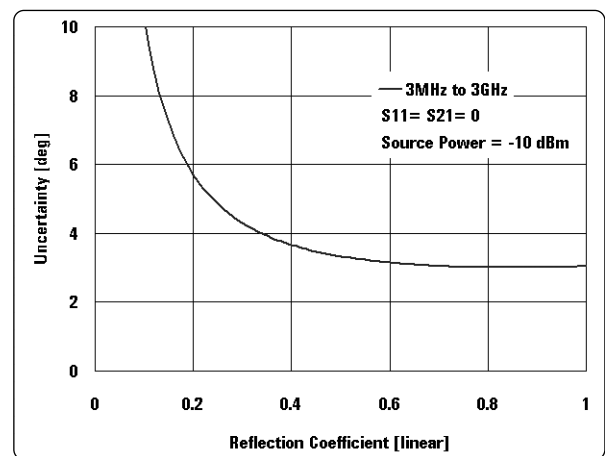

Agilent Technologies' Test and Measurement Support, Services, and Assistance

Agilent Technologies aims to maximize the value you receive, while minimizing your risk and problems. We strive to ensure that you get the test and measurement capabilities you paid for and obtain the support you need. Our extensive support resources and services can help you choose the right Agilent products for your applications and apply them successfully. Every instrument and system we sell has a global warranty. Support is available for at least five years beyond the production life of the product. Two concepts underlie Agilent's overall support policy: "Our Promise" and "Your Advantage."

Our Promise

Our Promise means your Agilent test and measurement equipment will meet its advertised performance and functionality. When you are choosing new equipment, we will help you with product information, including realistic performance specifications and practical recommendations from experienced test engineers. When you use Agilent equipment, we can verify that it works properly, help with product operation, and provide basic measurement assistance for the use of specified capabilities, at no extra cost upon request. Many self-help tools are available.

Your Advantage

Your Advantage means that Agilent offers a wide range of additional expert test and measurement services, which you can purchase according to your unique technical and business needs. Solve problems efficiently and gain a competitive edge by contracting with us for calibration, extra-cost upgrades, out-of-warranty repairs, and onsite education and training, as well as design, system integration, project management, and other professional engineering services. Experienced Agilent engineers and technicians worldwide can help you maximize your productivity, optimize the return on investment of your Agilent instruments and systems, and obtain dependable measurement accuracy for the life of those products.



Agilent Email Updates

www.agilent.com/find/emailupdates

Get the latest information on the products and applications you select.

Agilent T&M Software and Connectivity

Agilent's Test and Measurement software and connectivity products, solutions and developer network allows you to take time out of connecting your instruments to your computer with tools based on PC standards, so you can focus on your tasks, not on your connections. Visit **www.agilent.com/find/connectivity** for more information.

By internet, phone, or fax, get assistance with all your test & measurement needs

Phone or Fax

United States:

(tel) 800 829 4444

Canada:

(tel) 877 894 4414

(fax) 905 282 6495

China:

(tel) 800 810 0189

(fax) 800 820 2816

Europe:

(tel) (31 20) 547 2323

(fax) (31 20) 547 2390

Japan:

(tel) (81) 426 56 7832

(fax) (81) 426 56 7840

Korea:

(tel) (82 2) 2004 5004

(fax) (82 2) 2004 5115

Latin America:

(tel) (305) 269 7500

(fax) (305) 269 7599

Taiwan:

(tel) 0800 047 866

(fax) 0800 286 331

Other Asia Pacific Countries:

(tel) (65) 6375 8100

(fax) (65) 6836 0252

Email: tm_asia@agilent.com

Online Assistance:

www.agilent.com/find/assist

Product specifications and descriptions in this document subject to change without notice.

© Agilent Technologies, Inc. 2002, 2004

Printed in USA April 29, 2004

5988-3780EN

Microsoft, Windows and Visual Basic are U.S. registered trademarks of Microsoft Corporation.



Agilent Technologies