

Agilent 8720E Family Microwave Vector Network Analyzers

Data Sheet

8719ET Transmission/reflection vector network analyzer
8719ES S-Parameter vector network analyzer
50 MHz to 13.5 GHz

8720ET Transmission/reflection vector network analyzer
8720ES S-parameter vector network analyzer
50 MHz to 20 GHz

8722ET Transmission/reflection vector network analyzer
8722ES S-parameter vector network analyzer
50 MHz to 40 GHz



This document describes the performance and features of the Agilent Technologies 8720E family of network analyzers. For more information about these analyzers, please refer to the following documents:

Agilent 8720E family network analyzers overview, Agilent literature number 5968-5161E

Agilent 8720E family network analyzers configuration guide, Agilent literature number 5968-5162E



Agilent Technologies

Table of Contents

3	Definitions and test conditions
4	System performance
18	Specifications and characteristics
20	Measurement throughput summary
21	Options
23	System capabilities
30	Software
31	Accessories

Definitions and test conditions

Specifications describe the instrument's warranted performance after a half-hour warm-up and over the temperature range of $23^{\circ}\text{C} \pm 3^{\circ}\text{C}$, unless otherwise stated.

Supplemental characteristics are typical but non-warranted performance parameters. These are denoted as "typical," "nominal," or "approximate."

Dynamic range

System dynamic range is calculated as the difference between the receiver noise floor and the lesser of either the source maximum output or the receiver maximum input level. System dynamic range applies to transmission measurements only, since reflection measurements are limited by directivity.

Noise floor is specified as the mean plus three standard deviations of the linear magnitude noise floor trace over frequency. Noise floor is measured with the test ports terminated in loads, full two-port error correction for the 8719ES/8720ES/8722ES and enhanced response error correction for the 8719ET/8720ET/8722ET (with 16 averages used during isolation), 10 Hz IF bandwidth (BW), maximum test port power, and no averaging during the measurement.

Measurement uncertainty

Measurement uncertainty curves utilize an RSS (Root Sum Square) model for the contribution of random errors such as noise, typical connector repeatabilities, and test set switch; this is combined with a worst-case model for the contributions of dynamic accuracy and residual systematic errors.

Curves show the worst-case magnitude and phase uncertainty for reflection and transmission measurements, after a full two-port error correction for the 8719ES/8720ES/8722ES and enhanced-response error correction for the 8719ET/8720ET/8722ET (with 8 averages used during isolation), using the specified cal kit, with 10 Hz IF bandwidth (BW) and no averaging during the measurement.

Measurement port characteristics

Characteristics show the residual system uncertainties for both uncorrected performance and corrected performance using full two-port error correction for the 8719ES/8720ES/8722ES and enhanced-response error correction for the 8719ET/8720ET/8722ET. These characteristics apply for an environmental temperature of $23^{\circ}\text{C} \pm 3^{\circ}\text{C}$, with less than 1°C deviation from the calibration temperature. 8719ET/8720ET/8722ET Option 004 may degrade transmission source match as much as 2 dB, resulting in up to 0.05 dB additional uncertainty in transmission tracking.

Corrected performance indicates residual error after calibration. It is determined by the quality of calibration standards, plus system repeatability, stability, and noise.

Uncorrected performance indicates intrinsic errors without calibration correction applied. This is related to the ultimate stability of a calibration.

System performance

Agilent 8719ES and 8720ES with 3.5 mm test ports

Standard, Options 400, 012¹, 089, or any combination of these options.

Calibration kit: 85052B, 3.5-mm with sliding loads
Cables: HP 85131F 3.5-mm flexible cable set
IF bandwidth: 10 Hz
Averaging: None (8 during isolation calibration)

System dynamic range

0.05 to 0.84 GHz	77 dB
0.84 to 20 GHz	100 dB

Corrected measurement port specifications

	Frequency range (GHz)			
	0.05 to 0.5	0.5 to 2	2 to 8	8 to 20
Directivity	48 dB	48 dB	44 dB	44 dB
Source match	40 dB	40 dB	33 dB	31 dB
Load match	48 dB	48 dB	44 dB	44 dB
Reflection tracking	$\pm(0.006 \text{ dB} + 0.02 \text{ dB}/^\circ\text{C})$	$\pm(0.006 \text{ dB} + 0.03 \text{ dB}/^\circ\text{C})$	$\pm(0.006 \text{ dB} + 0.03 \text{ dB}/^\circ\text{C})$	$\pm(0.008 \text{ dB} + 0.04 \text{ dB}/^\circ\text{C})$
Transmission tracking	$\pm(0.017 \text{ dB} + 0.02 \text{ dB}/^\circ\text{C})$	$\pm(0.018 \text{ dB} + 0.03 \text{ dB}/^\circ\text{C})$	$\pm(0.066 \text{ dB} + 0.03 \text{ dB}/^\circ\text{C})$	$\pm(0.099 \text{ dB} + 0.04 \text{ dB}/^\circ\text{C})$

Maximum output power

+5 dBm

Measurement uncertainty

Reflection measurements

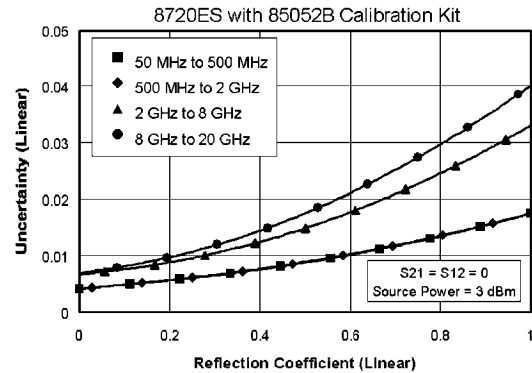

Magnitude

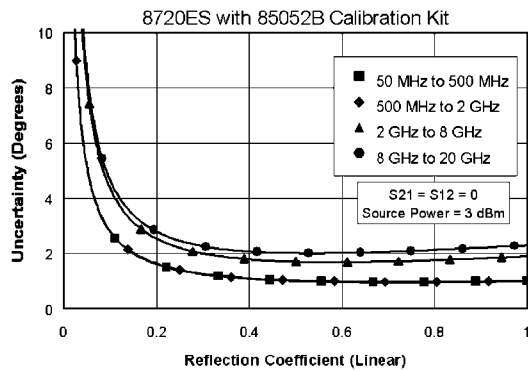

Phase

Transmission measurements

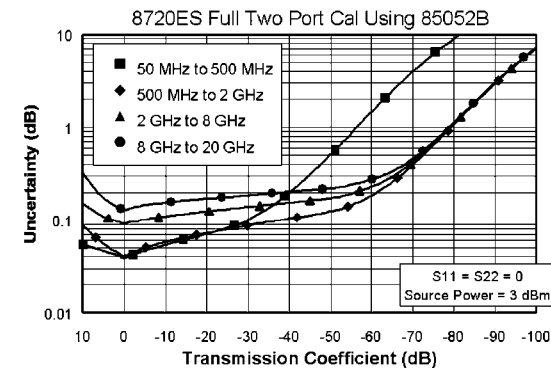

Magnitude

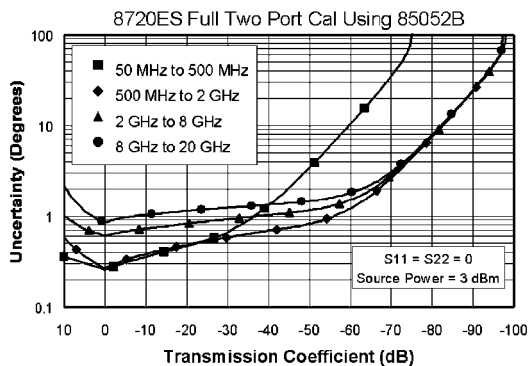

Phase

Agilent 8722ES with 2.4 mm test ports

Standard, Options 400, 012¹, 089, or any combination of these options.

Calibration kit: 85056A, 2.4-mm with sliding loads

Cables: 85133F 2.4-mm flexible cable set

IF bandwidth: 10 Hz

Averaging: None (8 during isolation calibration)

System dynamic range

0.05 to 0.84 GHz	67 dB
0.84 to 8 GHz	93 dB
8 to 20 GHz	91 dB
20 to 40 GHz	80 dB ²

Corrected measurement port specifications

	Frequency range (GHz)			
	0.05 to 2	2 to 8	8 to 20	20 to 40
Directivity	42 dB	42 dB	42 dB	38 dB
Source match	42 dB	38 dB	38 dB	33 dB
Load match	42 dB	42 dB	42 dB	38 dB
Reflection tracking	$\pm(0.005 \text{ dB} + 0.03 \text{ dB}/^\circ\text{C})$	$\pm(0.010 \text{ dB} + 0.03 \text{ dB}/^\circ\text{C})$	$\pm(0.010 \text{ dB} + 0.04 \text{ dB}/^\circ\text{C})$	$\pm(0.021 \text{ dB} + 0.06 \text{ dB}/^\circ\text{C})$
Transmission tracking	$\pm(0.020 \text{ dB} + 0.03 \text{ dB}/^\circ\text{C})$	$\pm(0.038 \text{ dB} + 0.03 \text{ dB}/^\circ\text{C})$	$\pm(0.048 \text{ dB} + 0.04 \text{ dB}/^\circ\text{C})$	$\pm(0.110 \text{ dB} + 0.06 \text{ dB}/^\circ\text{C})$

Maximum output power

0.05 to 20 GHz: -5 dBm

20 to 40 GHz: -10 dBm

Measurement uncertainty

Reflection measurements

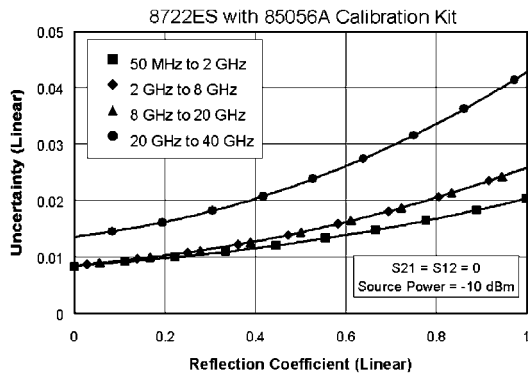

Magnitude

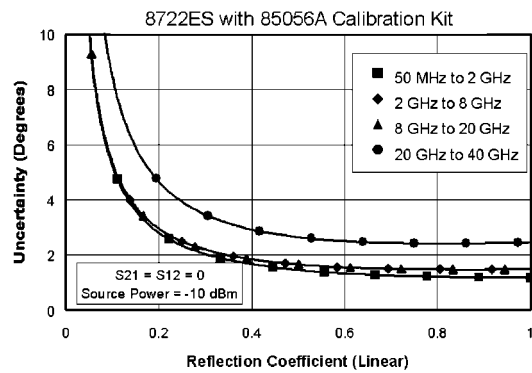

Phase

Transmission measurements

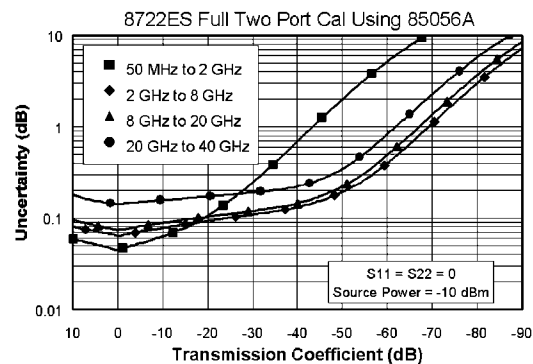

Magnitude

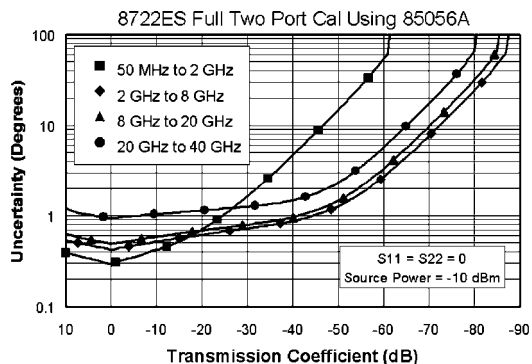

Phase

1. Internal test set not bypassed.
2. 3 dB less with Option 012.

System performance, continued

Agilent 8719ES and 8720ES

with 3.5 mm test ports

Standard, Options 400, 012¹, 089, or any combination of these options.

Calibration kit: 85052D, 3.5-mm with broadband loads

Cables: 85131F 3.5-mm flexible cable set

IF bandwidth: 10 Hz

Averaging: None (8 during isolation calibration)

System dynamic range

0.05 to 0.84 GHz	77 dB
0.84 to 20 GHz	100 dB

Corrected measurement port specifications

	Frequency range (GHz)			
	0.05 to 0.5	0.5 to 2	2 to 8	8 to 20
Directivity	42 dB	42 dB	38 dB	36 dB
Source match	37 dB	37 dB	31 dB	28 dB
Load match	42 dB	42 dB	38 dB	36 dB
Reflection tracking	$\pm(0.006 \text{ dB} + .02 \text{ dB}/^\circ\text{C})$	$\pm(0.006 \text{ dB} + .03 \text{ dB}/^\circ\text{C})$	$\pm(0.006 \text{ dB} + .03 \text{ dB}/^\circ\text{C})$	$\pm(0.009 \text{ dB} + .04 \text{ dB}/^\circ\text{C})$
Transmission tracking	$\pm(0.028 \text{ dB} + .02 \text{ dB}/^\circ\text{C})$	$\pm(0.03 \text{ dB} + .03 \text{ dB}/^\circ\text{C})$	$\pm(0.096 \text{ dB} + .03 \text{ dB}/^\circ\text{C})$	$\pm(0.158 \text{ dB} + .04 \text{ dB}/^\circ\text{C})$

Maximum output power

+5 dBm

Measurement uncertainty

Reflection measurements

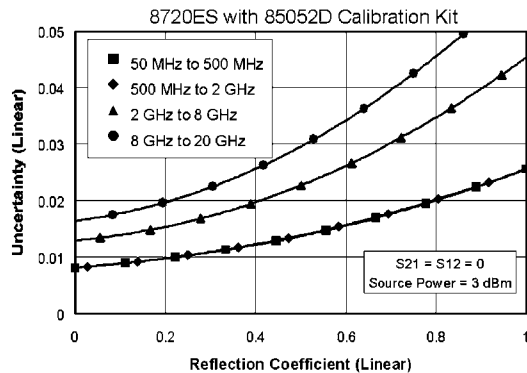

Magnitude

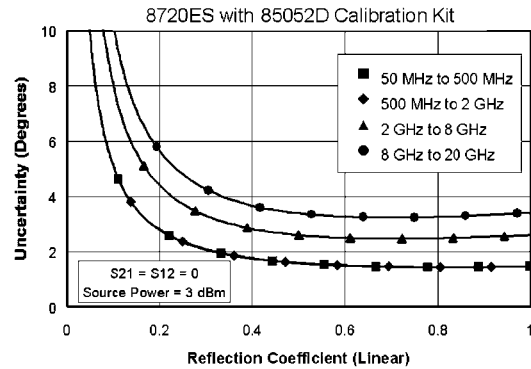

Phase

Transmission measurements

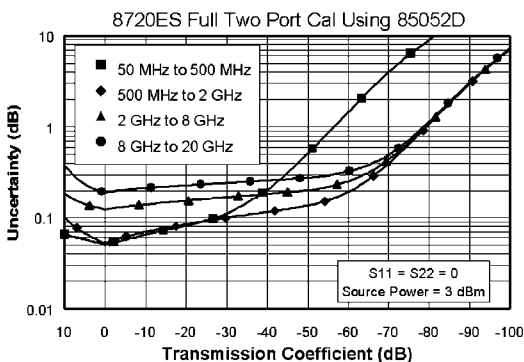

Magnitude

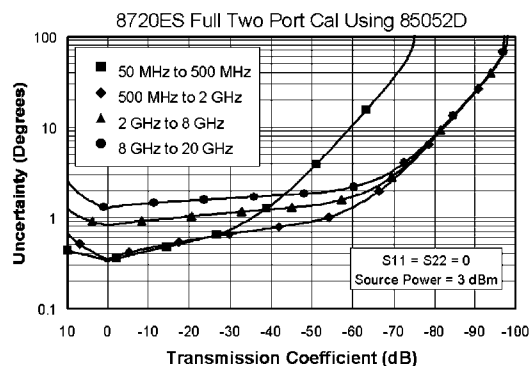

Phase

Agilent 8722ES with 2.4 mm test ports

Standard, Options 400, 012¹, 089, or any combination of these options.

Calibration kit: 85056D, 2.4-mm with broadband loads

Cables: 85133F 2.4-mm flexible cable set

IF bandwidth: 10 Hz

Averaging: None (8 during isolation calibration)

System dynamic range

0.05 to 0.84 GHz	67 dB
0.84 to 8 GHz	93 dB
8 to 20 GHz	91 dB
20 to 40 GHz	80 dB ²

Corrected measurement port specifications

	Frequency range (GHz)			
	0.05 to 2	2 to 8	8 to 20	20 to 40
Directivity	42 dB	42 dB	34 dB	26 dB
Source match	40 dB	40 dB	30 dB	23 dB
Load match	42 dB	42 dB	34 dB	26 dB
Reflection tracking	$\pm(0.006 \text{ dB} + 0.03 \text{ dB}/^\circ\text{C})$	$\pm(0.029 \text{ dB} + 0.03 \text{ dB}/^\circ\text{C})$	$\pm(0.029 \text{ dB} + 0.04 \text{ dB}/^\circ\text{C})$	$\pm(0.080 \text{ dB} + 0.06 \text{ dB}/^\circ\text{C})$
Transmission tracking	$\pm(0.022 \text{ dB} + 0.03 \text{ dB}/^\circ\text{C})$	$\pm(0.034 \text{ dB} + 0.03 \text{ dB}/^\circ\text{C})$	$\pm(0.116 \text{ dB} + 0.04 \text{ dB}/^\circ\text{C})$	$\pm(0.372 \text{ dB} + 0.06 \text{ dB}/^\circ\text{C})$

Maximum output power

0.05 to 20 GHz: -5 dBm

20 to 40 GHz: -10 dBm

Measurement uncertainty

Reflection measurements

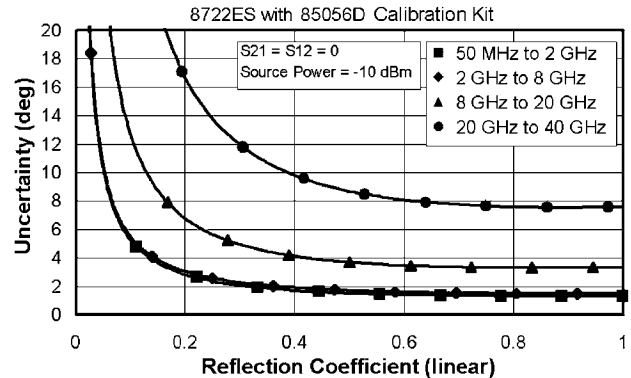
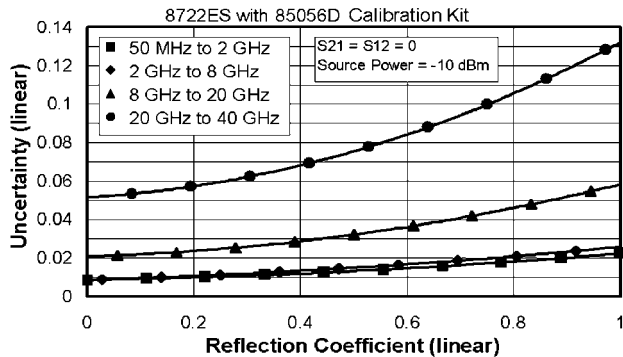

Magnitude

Transmission measurements

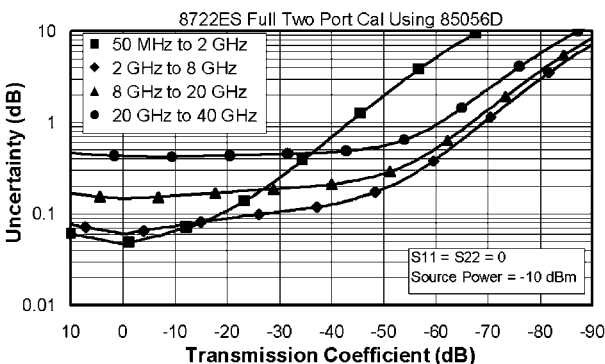

Phase

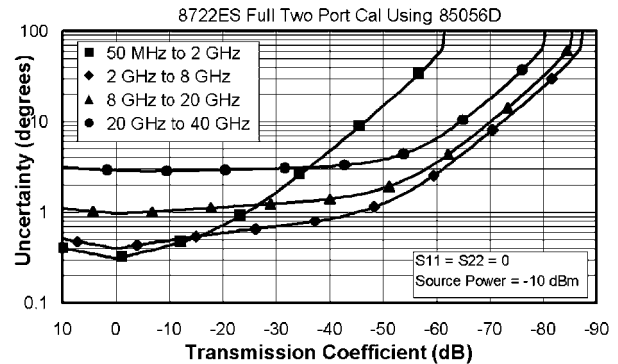

Magnitude

1. Internal test set not bypassed.
2. 3 dB less with Option 012.

Phase

System performance, continued

Agilent 8719ES Option 400, 8720ES Option 400, and 8722ES Option 400 with 3.5 mm test ports using TRL

Includes instruments with Options 012¹ and/or 089.

Calibration kit: 85052C, 3.5-mm for TRL

Cables: 85131F 3.5-mm flexible cable set

IF bandwidth: 10 Hz

Averaging: None (8 during isolation calibration)

Corrected measurement port specifications

8719ES/8720ES Option 400

	Frequency range (GHz)			
	0.05 to 0.5	0.5 to 2	2 to 8	8 to 20
Directivity	48 dB	48 dB	50 dB	50 dB
Source match	40 dB	40 dB	50 dB	50 dB
Load match	48 dB	48 dB	50 dB	50 dB
Reflection tracking	±(0.006 dB + 0.02 dB/°C)	±(0.006 dB + 0.03 dB/°C)	±(0.005 dB + 0.03 dB/°C)	±(0.005 dB + 0.04 dB/°C)
Transmission tracking	±(0.013 dB + 0.02 dB/°C)	±(0.017 dB + 0.03 dB/°C)	±(0.06 dB + 0.03 dB/°C)	±(0.019 dB + 0.04 dB/°C)

8722ES Option 400

	Frequency range (GHz)			
	0.05 to 2	2 to 8	8 to 20	20 to 26.5
Directivity	48 dB	50 dB	50 dB	50 dB
Source match	40 dB	50 dB	50 dB	50 dB
Load match	48 dB	50 dB	50 dB	50 dB
Reflection tracking	±(0.006 dB + 0.03 dB/°C)	±(0.005 dB + 0.03 dB/°C)	±(0.005 dB + 0.04 dB/°C)	±(0.005 dB + 0.06 dB/°C)
Transmission tracking	±(0.017 dB + 0.03 dB/°C)	±(0.013 dB + 0.03 dB/°C)	±(0.016 dB + 0.04 dB/°C)	±(0.023 dB + 0.06 dB/°C)

System dynamic range

Frequency range	8719ES/8720ES	8722ES
0.05 to 0.084 GHz	77 dB	67 dB
0.084 to 8 GHz	100 dB	93 dB
8 to 20 GHz	100 dB	91 dB
20 to 40 GHz	—	80 dB ²

Maximum output power

8719ES/8720ES: +5 dBm

8722ES (0.05 to 20 GHz): -5 dBm

(20 to 40 GHz): -10 dBm

Measurement uncertainty

Reflection measurements

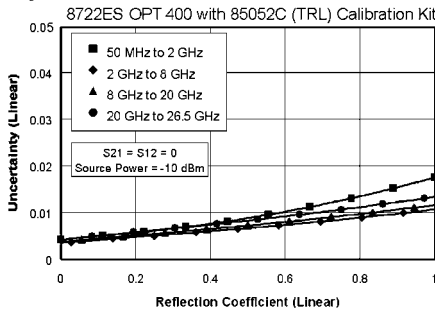

Magnitude

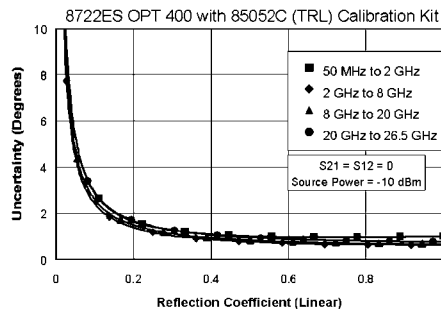

Phase

Transmission measurements

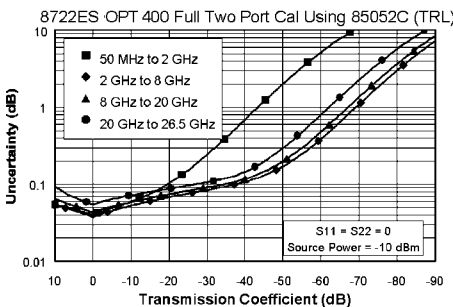

Magnitude

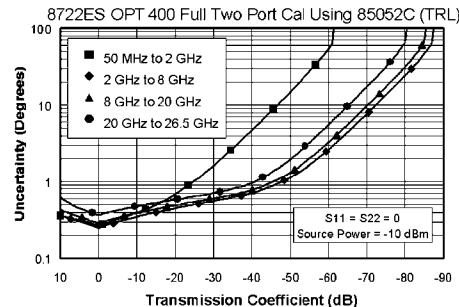

Phase

1. Internal test set not bypassed.
2. 3 dB less with Option 012.

Agilent 8719ES, 8720ES, and 8722ES Option 007 Agilent 8719ES, 8720ES, and 8722ES Option 085

Includes instruments with Options 012¹ and/or 089.

Option 007 replaces the standard solid-state transfer switch with a mechanical switch to provide higher output power.

Option 085 adds internally controlled 0 to 55 dB step attenuators (5 dB steps) in the receiver path of both ports, an RF loop that allows the addition of an amplifier before the transfer switch, and RF loops after the switch that allow insertion of isolators, required for measurements above 1 watt. An internal reference channel switch is added and internal bias tees are deleted. This system is capable of full two-port calibrated measurements to 20 watts. Measurements up to 100 watts may be possible using specific configurations. Option 085 includes direct sampler access (Option 012). Option 085 is not compatible with Option 400.

System dynamic range

Frequency range (GHz)	Option 007		Option 085	
	8719ES/20ES	8722ES	8719D/20ES	8722ES
0.05 to 0.84	82 dB	72 dB	82 dB	72 dB
0.84 to 8	105 dB	98 dB	105 dB	98 dB
8 to 20	105 dB	96 dB	105 dB	96 dB
20 to 40	—	85 dB	—	82 dB

Maximum output power

	Option 007	Option 085 ²
8719ES/8720ES	+10 dBm	+5 dBm
8722ES (0.05 to 20 GHz)	0 dBm	-5 dBm
8722ES (20 to 40 GHz)	-5 dBm	-10 dBm

Supplemental characteristics (Option 085)

Maximum R-channel input level: 0 dBm

Minimum R-channel input level: -34 dBm

Maximum RF port input: +43 dBm

Attenuators: 55 dB maximum, 5 dB steps

Maximum test port power (no isolators): +30 dBm

Maximum test port power (with high power isolators): +43 dBm

Option 085 block diagram and example high power measurement setup

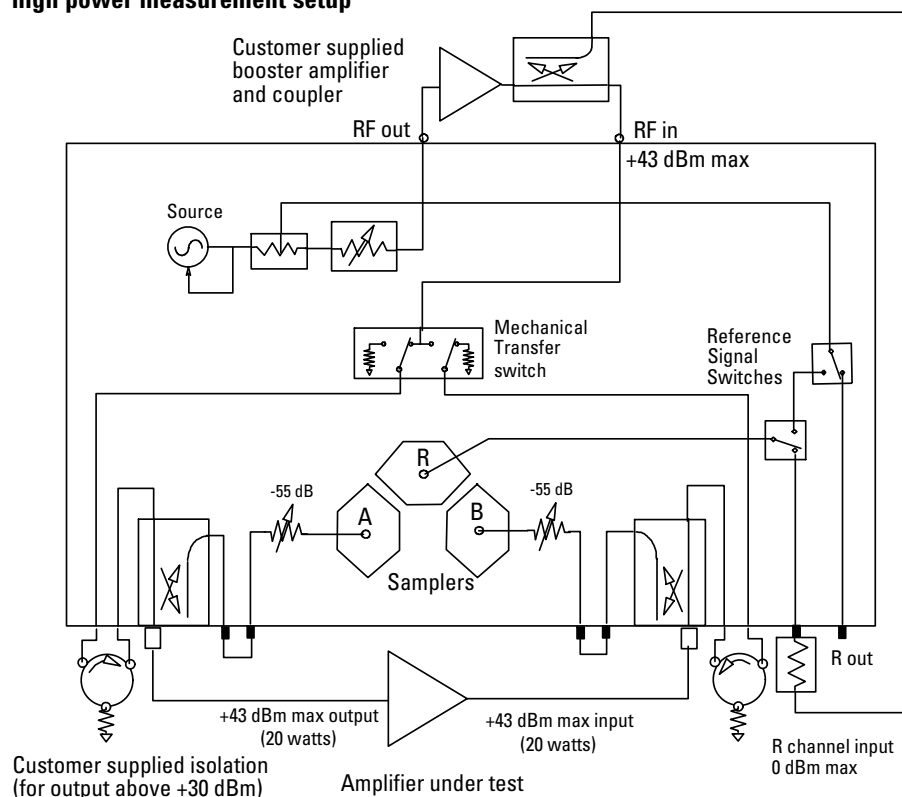

1. Internal test set not bypassed.
2. With jumper cable installed between RF out and RF in ports: that is, no external amplification.

System performance, continued

Agilent 8719ES or 8720ES with Option 007 or 085

Calibration kit: 85052B 3.5-mm with sliding loads

Cables: 85131F 3.5-mm flexible cable set

IF bandwidth: 10 Hz

Averaging: None (8 during isolation calibration)

Corrected measurement port specifications

	Frequency range (GHz)			
	0.05 to 0.5	0.5 to 2	2 to 8	8 to 20
Directivity	48 dB	48 dB	44 dB	44 dB
Source match	40 dB	39 dB	32 dB	30 dB
Load match	48 dB	48 dB	44 dB	44 dB
Reflection tracking	$\pm(0.006 \text{ dB} + .02 \text{ dB}/^\circ\text{C})$	$\pm(0.010 \text{ dB} + .03 \text{ dB}/^\circ\text{C})$	$\pm(0.030 \text{ dB} + .03 \text{ dB}/^\circ\text{C})$	$\pm(0.031 \text{ dB} + .04 \text{ dB}/^\circ\text{C})$
Transmission tracking	$\pm(0.011 \text{ dB} + .02 \text{ dB}/^\circ\text{C})$	$\pm(0.016 \text{ dB} + .03 \text{ dB}/^\circ\text{C})$	$\pm(0.066 \text{ dB} + .03 \text{ dB}/^\circ\text{C})$	$\pm(0.108 \text{ dB} + .04 \text{ dB}/^\circ\text{C})$

Measurement uncertainty

Reflection measurements

8720ES OPT 007 or 085 with 85052B
Calibration Kit

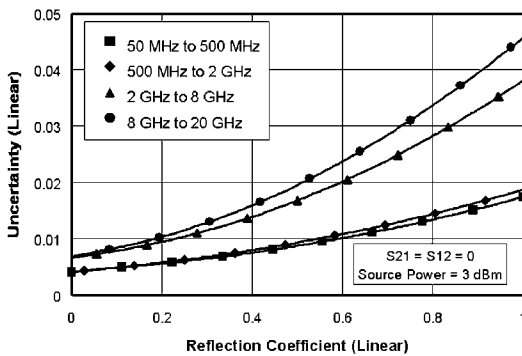

8720ES OPT 007 or 085 with 85052B
Calibration Kit

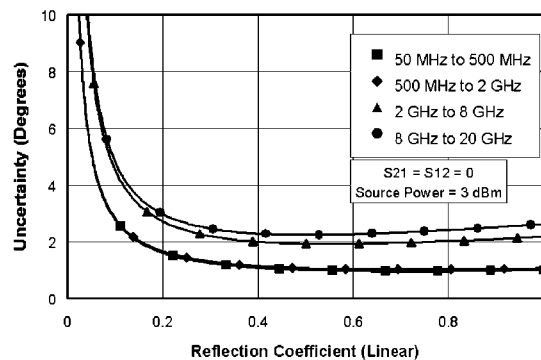

Magnitude

Phase

Transmission measurements

8720ES OPT 007 or 085 with 85052B
Calibration Kit

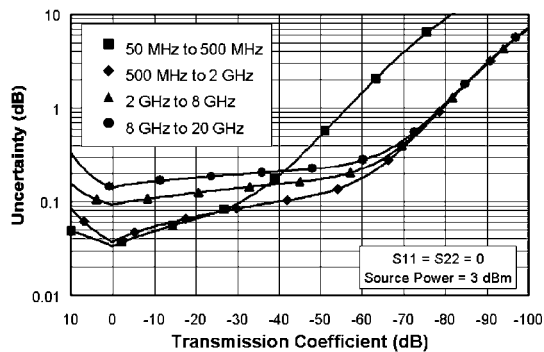

8720ES OPT 007 or 085 with 85052B
Calibration Kit

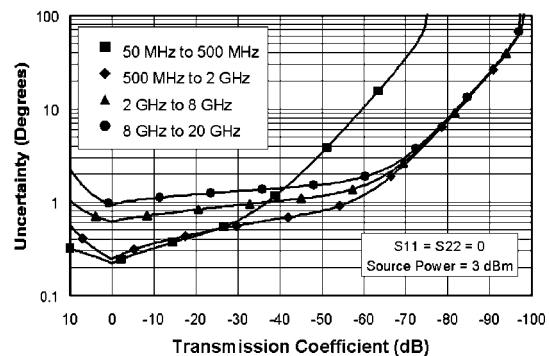

Magnitude

Phase

Agilent 8719ES or 8720ES with Option 007 or 085

Calibration kit: 85052D 3.5-mm with fixed loads

Cables: 85131F 3.5-mm flexible cable set

IF bandwidth: 10 Hz

Averaging: None (8 during isolation calibration)

Corrected measurement port specifications

	Frequency range (GHz)			
	0.05 to 0.5	0.5 to 2	2 to 8	8 to 20
Directivity	42 dB	42 dB	38 dB	36 dB
Source match	37 dB	37 dB	30 dB	28 dB
Load match	42 dB	41 dB	36 dB	34 dB
Reflection tracking	$\pm(0.006 \text{ dB} + .02 \text{ dB}/^\circ\text{C})$	$\pm(0.01 \text{ dB} + .03 \text{ dB}/^\circ\text{C})$	$\pm(0.03 \text{ dB} + .03 \text{ dB}/^\circ\text{C})$	$\pm(0.31 \text{ dB} + .04 \text{ dB}/^\circ\text{C})$
Transmission tracking	$\pm(0.018 \text{ dB} + .02 \text{ dB}/^\circ\text{C})$	$\pm(0.019 \text{ dB} + .03 \text{ dB}/^\circ\text{C})$	$\pm(0.080 \text{ dB} + .03 \text{ dB}/^\circ\text{C})$	$\pm 0.141 \text{ dB} + .04 \text{ dB}/^\circ\text{C}$

Measurement uncertainty

Reflection measurements

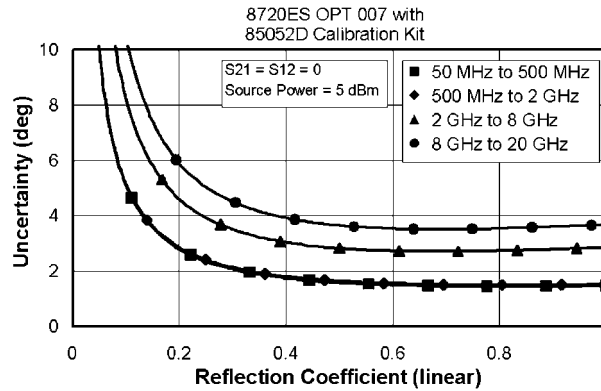
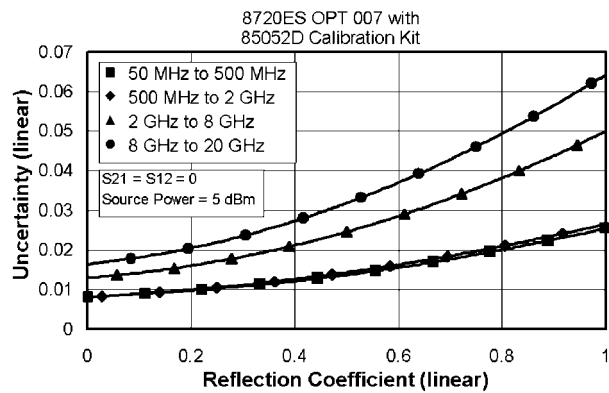

Magnitude

Transmission measurements

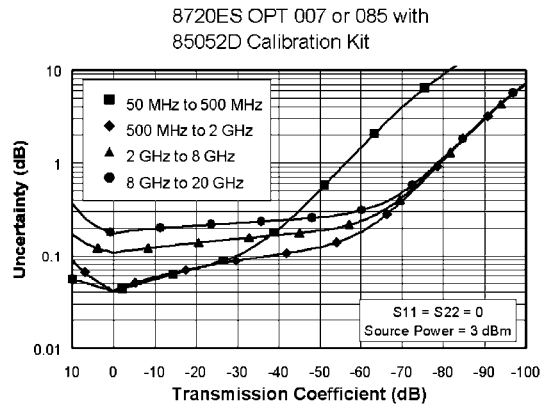

Magnitude

Phase

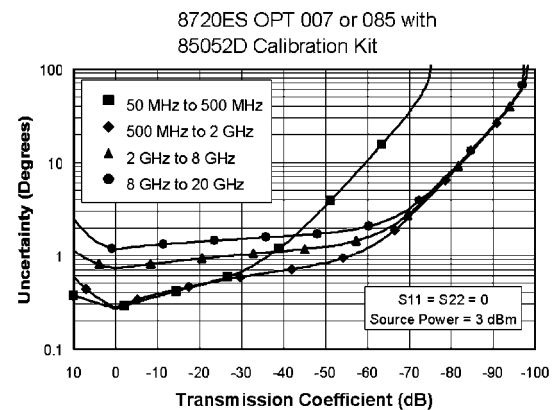

Phase

System performance, continued

Agilent 8722ES with Option 007 or 085

Calibration kit: 85056A 2.4-mm with sliding loads

Cables: 85133F 2.4-mm flexible cable set

IF bandwidth: 10 Hz

Averaging: None (8 during isolation calibration)

Corrected measurement port specifications

	Frequency range (GHz)			
	0.05 to 2	2 to 8	8 to 20	20 to 40
Directivity	42 dB	42 dB	42 dB	38 dB
Source match	40 dB	35 dB	34 dB	31 dB
Load match	41 dB	38 dB	37 dB	35 dB
Reflection tracking	$\pm(0.011 \text{ dB} + .03 \text{ dB}/^\circ\text{C})$	$\pm(0.037 \text{ dB} + .03 \text{ dB}/^\circ\text{C})$	$\pm(0.039 \text{ dB} + .04 \text{ dB}/^\circ\text{C})$	$\pm(0.047 \text{ dB} + .06 \text{ dB}/^\circ\text{C})$
Transmission tracking	$\pm(0.021 \text{ dB} + .03 \text{ dB}/^\circ\text{C})$	$\pm(0.054 \text{ dB} + .03 \text{ dB}/^\circ\text{C})$	$\pm(0.085 \text{ dB} + .04 \text{ dB}/^\circ\text{C})$	$\pm(0.149 \text{ dB} + .06 \text{ dB}/^\circ\text{C})$

Measurement uncertainty

Reflection measurements

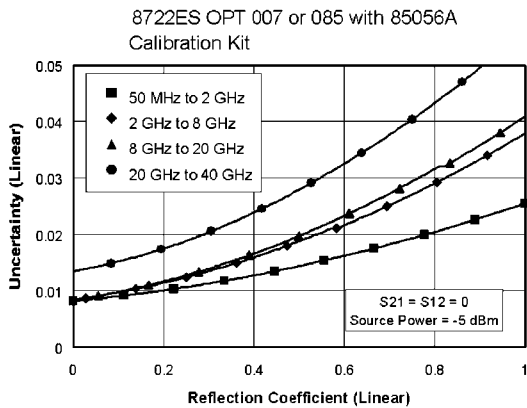

Magnitude

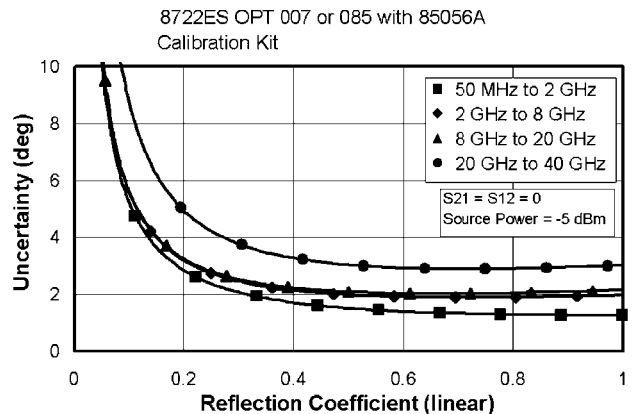

Phase

Transmission measurements

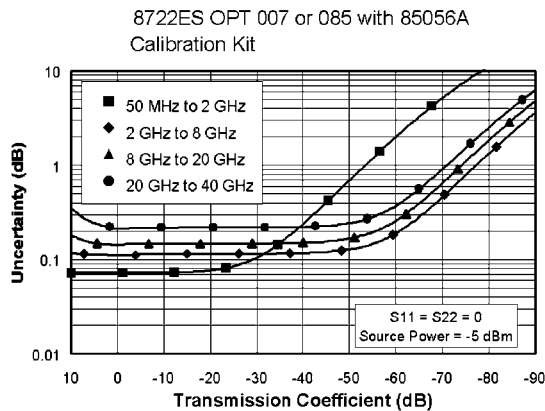

Magnitude

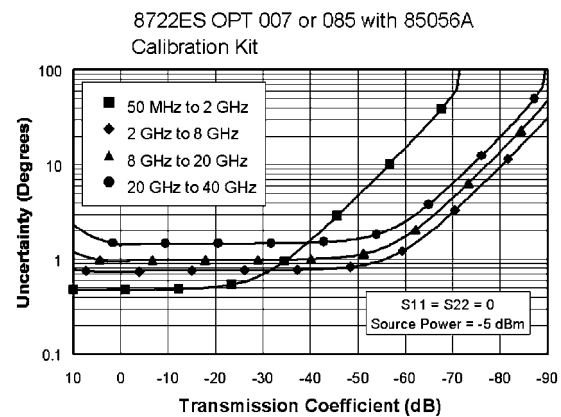

Phase

Agilent 8722ES with Option 007 or 085

Calibration kit: 85056D 2.4-mm with fixed loads

Cables: 85133F 2.4-mm flexible cable set

IF bandwidth: 10 Hz

Averaging: None (8 during isolation calibration)

Corrected measurement port specifications

	Frequency range (GHz)			
	0.05 to 2	2 to 8	8 to 20	20 to 40
Directivity	42 dB	42 dB	34 dB	26 dB
Source match	39 dB	36 dB	29 dB	23 dB
Load match	41 dB	38 dB	33 dB	26 dB
Reflection tracking	$\pm(0.011 \text{ dB} + .03 \text{ dB}/^\circ\text{C})$	$\pm(0.046 \text{ dB} + .03 \text{ dB}/^\circ\text{C})$	$\pm(0.048 \text{ dB} + .04 \text{ dB}/^\circ\text{C})$	$\pm(0.090 \text{ dB} + .06 \text{ dB}/^\circ\text{C})$
Transmission tracking	$\pm(0.022 \text{ dB} + .03 \text{ dB}/^\circ\text{C})$	$\pm(0.053 \text{ dB} + .03 \text{ dB}/^\circ\text{C})$	$\pm(0.130 \text{ dB} + .04 \text{ dB}/^\circ\text{C})$	$\pm(0.367 \text{ dB} + .06 \text{ dB}/^\circ\text{C})$

Measurement uncertainty

Reflection measurements

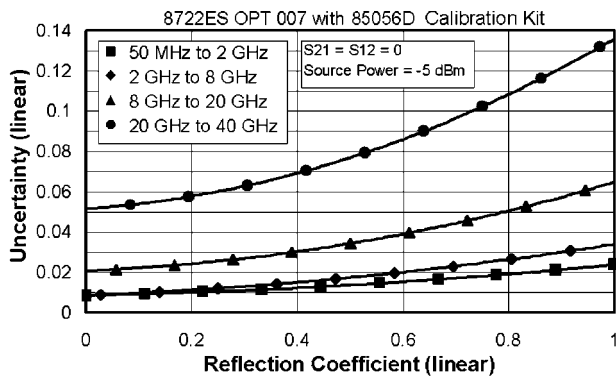

Magnitude

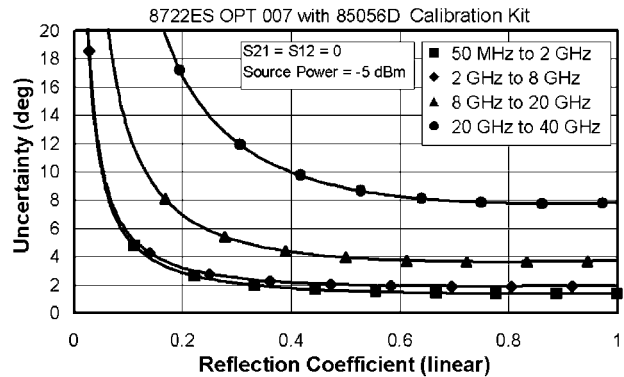

Phase

Transmission measurements

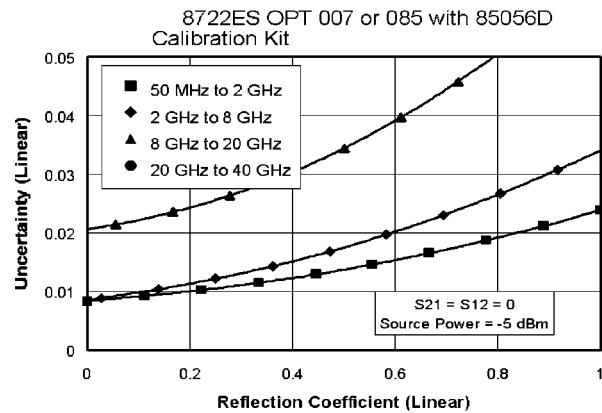

Magnitude

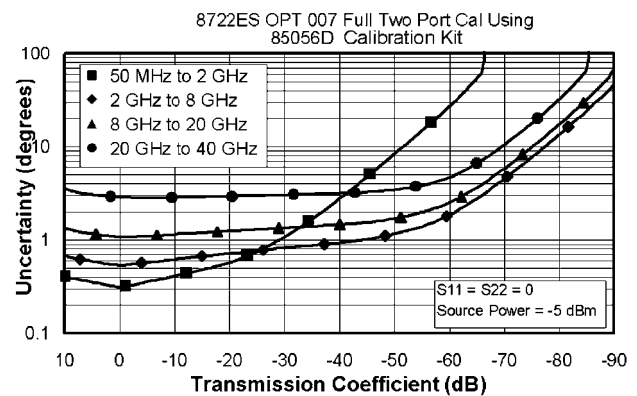

Phase

System performance, continued

Agilent 8719ET and 8720ET with 3.5 mm test ports

Standard or Option 004

Calibration kit: 85052B 3.5-mm with sliding loads

Cables: 85131F 3.5-mm flexible cable set

IF bandwidth: 10 Hz

Averaging: None (8 during isolation calibration)

System dynamic range

0.05 to 0.84 GHz	102 dB
0.84 to 20 GHz	104 dB

Power range:

Standard: -10 to +10 dBm

Option 004: -65 to +10 dBm

Measurement uncertainty

Reflection measurements

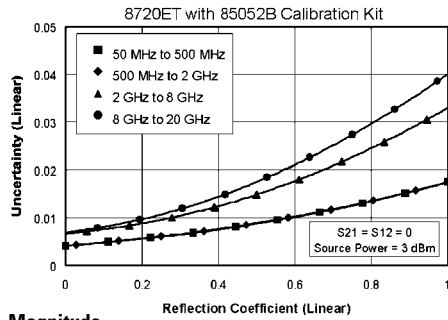

Magnitude

Corrected measurement port specifications (3.5 mm)

	Frequency range (GHz)			
	0.050 to 0.5	0.5 to 2	2 to 8	8 to 20
Reflection Measurements¹				
Directivity	48 dB	48 dB	44 dB	44 dB
Source match	40 dB	40 dB	33 dB	31 dB
Load match				
One-port Cal	22 dB	22 dB	22 dB	17 dB
Enhanced Reflection Cal	22 dB	22 dB	22 dB	17 dB
Reflection tracking	±(0.006 dB +0.02 dB/°C)	±(0.006 dB +0.03 dB/°C)	±(0.006 dB +0.03 dB/°C)	±(0.008 dB +0.04 dB/°C)
Transmission measurements²				
Source match				
Enhanced Response Cal	40 dB	40 dB	33 dB	31 dB
Response Only Cal	16 dB	20 dB	14 dB	11 dB
Transmission tracking				
Enhanced Response Cal	±(0.014 dB +0.02 dB/°C)	±(0.012 dB +0.03 dB/°C)	±(0.027 dB +0.03 dB/°C)	±(0.050 dB +0.04 dB/°C)
Response Only Cal	±(0.109 dB +0.02 dB/°C)	±(0.069 dB +0.03 dB/°C)	±(0.137 dB +0.03 dB/°C)	±(0.339 dB +0.04 dB/°C)
Load match	22 dB	22 dB	22 dB	17 dB

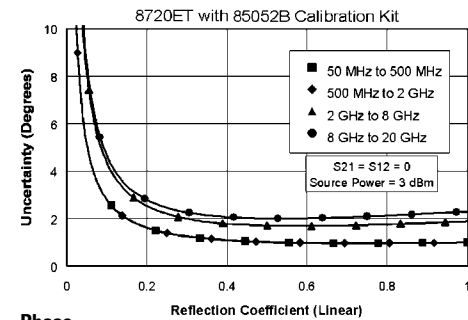

Phase

Transmission measurements

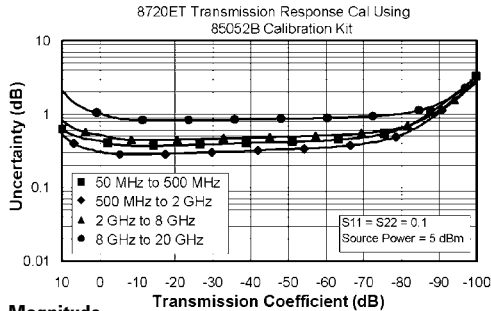

Magnitude

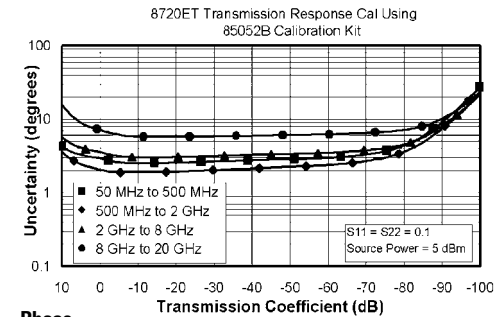

Phase

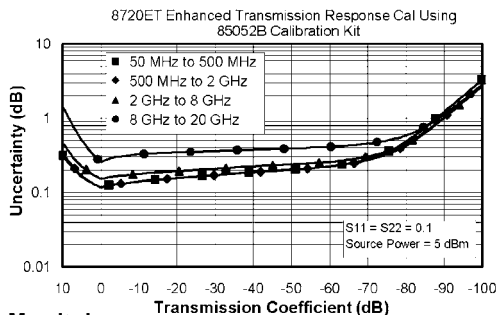

Magnitude

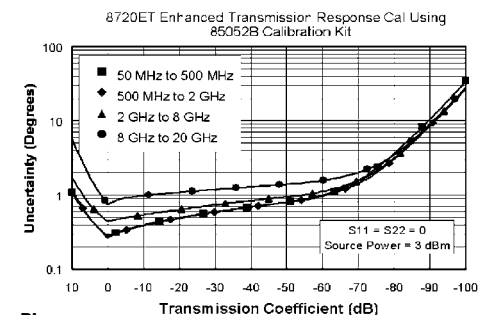

Phase

1. One-port or enhanced-response calibration
2. Enhanced-response or response-only calibration
3. Option 004 may degrade uncorrected source match as much as 2 dB.

Agilent 8722ET with 2.4 mm test ports

Standard or Option 004

Calibration kit: 85056A 2.4-mm with sliding loads
 Cables: 85133F 2.4-mm flexible cable set
 IF bandwidth: 10 Hz
 Averaging: None (8 during isolation calibration)

System dynamic range

0.05 to 0.84 GHz	98 dB
0.84 to 8 GHz	102 dB
8 to 20 GHz	100 dB
20 to 40 GHz	89 dB

Power range

0.05 to 20 GHz: -15 to 0 dBm
 20 to 40 GHz: -15 to -5 dBm
 Option 004
 0.05 to 20 GHz: -70 to 0 dBm
 20 to 40 GHz: -70 to -5 dBm

Measurement uncertainty

Reflection measurements

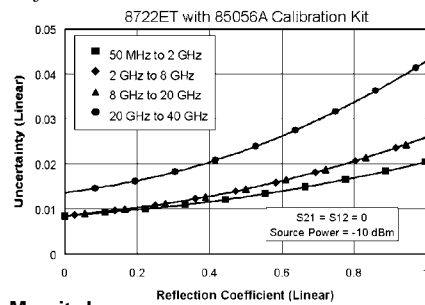

Magnitude

Transmission measurements

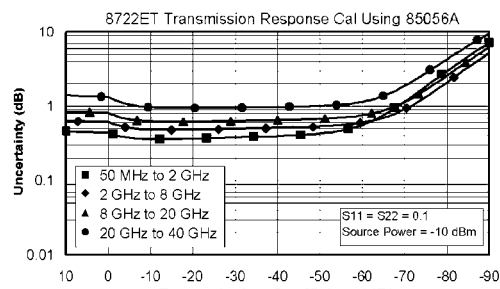

Magnitude

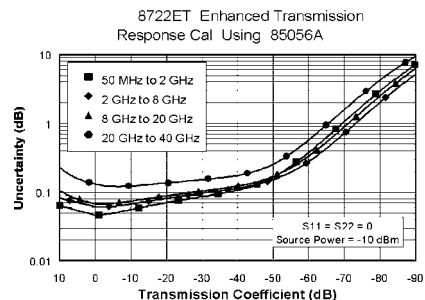

Magnitude

Corrected measurement port specifications (2.4 mm)

	Frequency range (GHz)			
	0.050 to 2	2 to 8	8 to 20	20 to 40
Reflection Measurements¹				
Directivity	42 dB	42 dB	42 dB	38 dB
Source match	41 dB	38 dB	38 dB	33 dB
Load match				
One-port Cal	20 dB	20 dB	20 dB	15 dB
Enhanced Reflection Cal	20 dB	20 dB	20 dB	15 dB
Reflection tracking	±(0.005 dB +0.03 dB/°C)	±(0.010 dB +0.03 dB/°C)	±(0.010 dB +0.04 dB/°C)	±(0.021 dB +0.06 dB/°C)
Transmission measurements²				
Source match				
Enhanced Response Cal	41 dB	38 dB	38 dB	33 dB
Response Only Cal	16 dB	14 dB	11 dB	10 dB
Transmission tracking				
Enhanced Response Cal	±(0.018 dB +0.03 dB/°C)	±(0.026 dB +0.03 dB/°C)	±(0.031 dB +0.04 dB/°C)	±(0.069 dB +0.06 dB/°C)
Response Only Cal	±(0.109 dB +0.03 dB/°C)	±(0.172 dB +0.03 dB/°C)	±(0.241 dB +0.04 dB/°C)	±(0.475 dB +0.06 dB/°C)
Load match	20 dB	20 dB	20 dB	15 dB

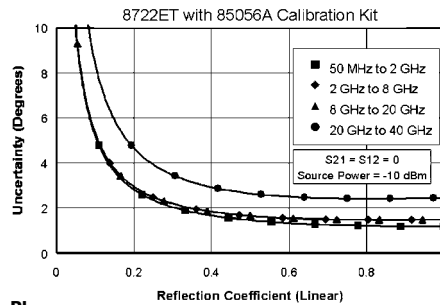

Phase

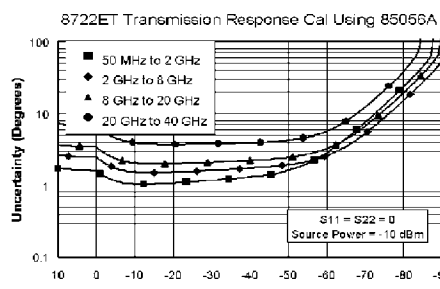

Phase

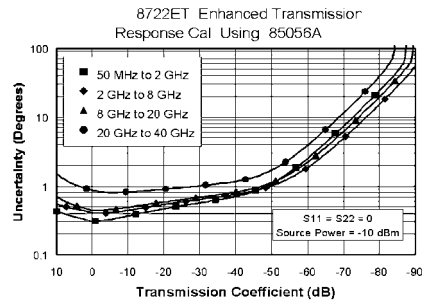

Phase

- One-port or enhanced-response calibration
- Enhanced-response or response-only calibration
- Option 004 may degrade uncorrected source match as much as 2 dB.

System performance, continued

Agilent 8719ES, 8720ES, or 8722ES Option 012

Option 012 adds RF loops that provide direct access to the A and B samplers in the port 1 and port 2 receivers. This allows transmission measurements that bypass the receiver coupler for improved signal-to-noise and sensitivity. The system is capable of antenna measurements to -110 dBm at 40 GHz, and filter rejection measurements to 120 dB. Use of multiple antennae provides improved signal-to-noise for free-space transmission and reflection measurements. The RF loops can also be used to integrate components into the test set. Adding a 20 dB attenuator increases the test port 0.1 dB compression level to +30 dBm. With front panel jumpers installed, the system operates as a standard system and meets standard instrument specifications.

Option 012 test set block diagram

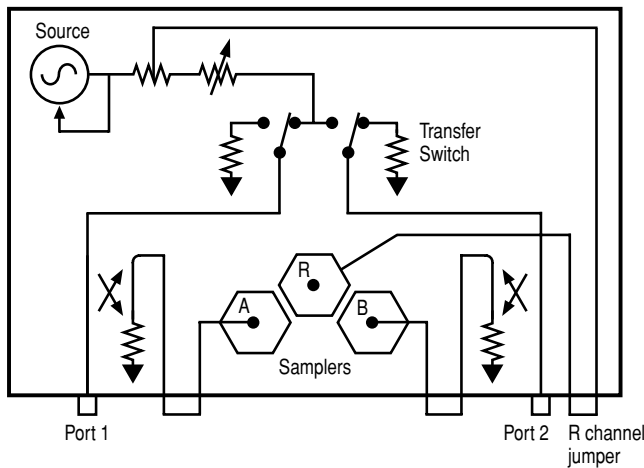

Option 400 and 012 test set block diagram

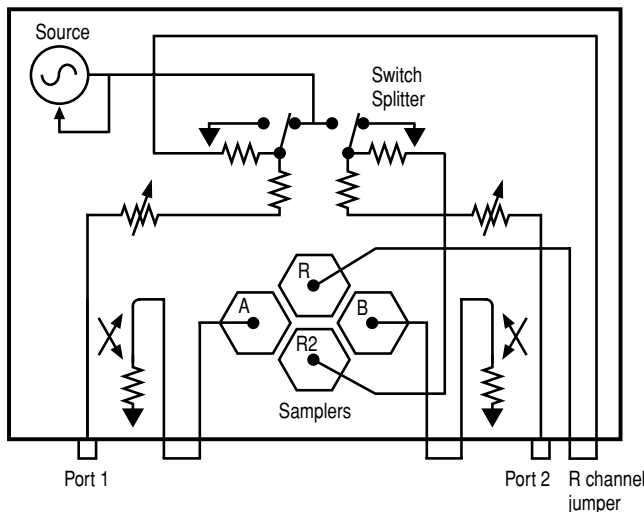

Supplemental characteristics (Option 012)

	Frequency range (GHz)				
	0.05 to 0.5	0.5 to 2	2 to 8	8 to 20	20 to 40
Compression¹					
Test Port^{1,2}	13 dB	10 dB	10 dB	10 dB	10 dB
Compression¹					
Direct Sampler Input	-5 dBm	-5 dBm	-5 dBm	-5 dBm	-5 dBm
Average					
Noise Floor²	-120 dBm	-120 dBm	-120 dBm	-118 dBm	-113 dBm
Receiver					
Dynamic Range	115 dB	115 dB	115 dB	113 dB	108 dB

Measure filter rejection to -120 dB

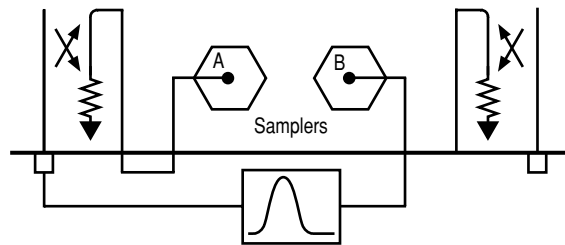

Measure amplifier output to +43 dBm

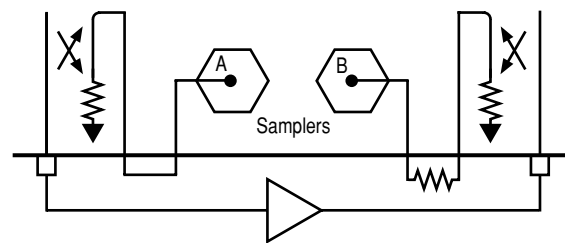

16 dB more sensitivity for antenna test. Improved signal-to-noise for free-space materials test.

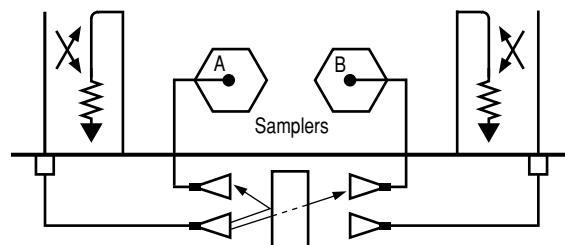

1. Input power level that causes 0.1 dB compression in the receiver.
 2. 10 Hz IF BW.

Agilent 8719ES, 8720ES, and 8722ES Option 089

Option 089 adds frequency offset mode, allowing the receiver to be offset from the source frequency. This allows direct conversion loss measurement of mixers without need for a reference mixer. RF and IF frequencies must be within the specified operating range of the instrument. This test set modification adds an internal reference channel switch and deletes the reference channel output. Firmware guides the user through the test setup. When not in frequency offset mode, the system operates as a standard system and meets standard instrument specifications.

Supplemental characteristics (Option 089)

	8719ES/8720ES	8722ES
Reference (R) Input Level		
Minimum	-34 dBm	-34 dBm
Maximum (for 0.1 dB compression)	-7 dBm	-12 dBm
Maximum (damage level)	0 dBm	0 dBm

Note: To utilize full instrument receiver dynamic range, measure test signal at port 2. This configuration requires a power splitter and reference mixer to provide a phase lock signal to the R channel input.

Option 089 test set block diagram

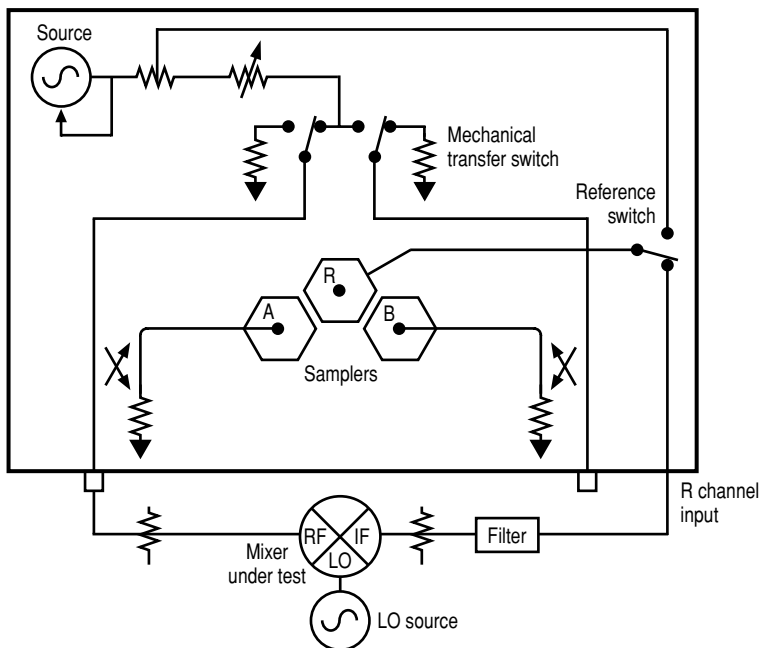

Analyzer's guided test setup display

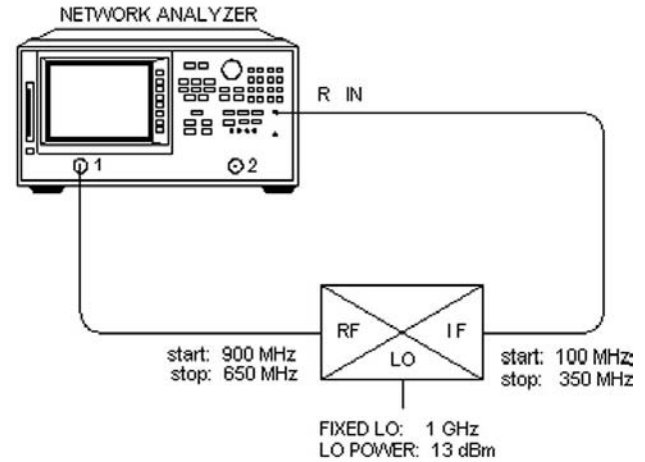

Specifications and characteristics

Agilent 8719ES, 8720ES, and 8722ES

Description		Code
Frequency		
Range		
8719ES	0.05 to 13.51 GHz	S
8720ES	0.05 to 20.05 GHz	S
8722ES	0.05 to 40.05 GHz	S
Accuracy (at 23° C ±3° C)	±10 ppm	S
Stability		
0° to 55° C	±7.5 ppm	C
Option 1D5	±0.05 ppm	C
Per year (aging)	±3 ppm	C
Option 1D5	±0.5 ppm	C
Resolution	1 Hz	S
System		
Maximum input level	10 dBm	S
Damage level (test port)	30 dBm or 40V dc	C
Trace noise ¹		
Magnitude (RMS of peak-to-peak value)		
0.05 to 13.5 GHz	<0.03 dB	C
13.5 to 20 GHz	<0.04 dB	C
20 to 40 GHz	<0.15 dB	C
Phase (RMS of peak-to-peak value)		
0.05 to 13.5 GHz	<0.3°	C
13.5 to 20 GHz	<0.4°	C
20 to 40 GHz	<1.5°	C
Spectral purity		
Harmonics at maximum output level	<-15 dBc	C
Phase noise		
to 60 kHz from carrier at 2 GHz	<-55 dBc	T
to 60 kHz from carrier at 20 GHz	<-35 dBc	T
Nonharmonic spurious signals		
at 100 kHz offset	<-40 dBc	T
at 200 kHz offset	<-45 dBc	T
at >200 kHz offset	<-65 dBc	T

Description		Code
Power		
Power range		
8719ES/8720ES	75 dB	C
8722ES		
0.05 to 20 GHz	70 dB	C
20 to 40 GHz	65 dB	C
Maximum output power		
8719ES/8720ES (standard, Options 085, 400)	+5 dBm	C
8719ES/8720ES (Option 007)	+10 dBm	C
8722ES (standard, Options 085, 400)		
0.05 to 20 GHz	-5 dBm	C
20 to 40 GHz	-10 dBm	C
8722ES (Option 007)		
0.05 to 20 GHz	0 dBm	C
20 to 40 GHz	-5 dBm	C
Resolution	0.01 dB	S
Level accuracy (at 5 dB below maximum output power)		
8719ES/8720ES	±2 dB	S
8722ES	±3 dB	S
Power sweep range		
8719ES/8720ES	20 dB	S
8719ES/8720ES	30 dB	T
8722ES	15 dB	S
8722ES	25 dB	T
8722ES	10 dB	S
8722ES	20 dB	T
Power linearity		
-5 dB from reference:		
8719ES/8720ES	±0.35	S
8722ES	±0.35	S
8722ES	±0.60	S
+5 dB from reference:		
8719ES/8720ES	±0.35	S
8722ES	±0.35	S
8722ES	N/A	
-10 dB from reference:		
8719ES/8720ES/8722ES	±0.60	S
+10 dB from reference:		
8719ES/8720ES	±1.0	S
8722ES	N/A	
Test reference power levels:		
8719ES/8720ES (standard, Options 085, 400)	-5 dBm	S
8719ES/8720ES (Option 007)	0 dBm	S
8722ES (standard, Options 085, 400)	-10 dBm	S
8722ES (Option 007)	-5 dBm	S

Frequency range (GHz)

Description	0.05 to 0.84	0.84 to 2	2 to 8	8 to 20	20 to 40	Code
System						
Dynamic range ²						
8719ES/8720ES (standard, Options 085, 400)	77 dB	100 dB	100 dB	100 dB		S
8719ES/8720ES (Option 007)	82 dB	105 dB	105 dB	105 dB		S
8722ES (standard ³ , Options 085, 400)	67 dB	93 dB	93 dB	91 dB	80 dB ⁴	S
8722ES (Option 007)	72 dB	98 dB	98 dB	96 dB	85 dB	S
Receiver 0.1 dB compression input level ⁵	13 dBm	10 dBm	10 dBm	10 dBm	10 dBm	T

Codes

- (S) Specification: warranted performance. Specifications include guardbands to account for expected statistical performance distribution, measurement uncertainties, and changes in performance due to environmental conditions.
- (C) Characteristic: a performance parameter that the product is expected to meet before it leaves the factory, but that is not verified in the field and is not covered by the warranty. A characteristic includes the same guardbands as a specification.
- (T) Typical (typ.): expected performance of an average unit which does not include guardbands. It is not covered by the product warranty.
- (N) Nominal (nom.): a general, descriptive term that does not imply a level of performance. It is not covered by the product warranty.

- Trace noise is defined as variation of a high signal level trace due to noise. The value given represents a noise variation that is the RMS of the peak-to-peak value as measured in a 3 kHz IF bandwidth in the fast sweep mode (STEP SWP OFF).
- The dynamic range specifications apply to transmission measurements using 10 Hz IF BW and response and isolation correction or full two-port correction. Dynamic range is limited by the maximum test port power and the receiver's noise floor.
- With 85133E flexible cable on test port.
- 77 dB for Option 085.
- For Option 012 direct sampler input compression levels, refer to page 16.

Agilent 8719ET, 8720ET, and 8722ET

Description	Code		
Frequency			
Range			
8719ET	0.05 to 13.51 GHz	S	
8720ET	0.05 to 20.05 GHz	S	
8722ET	0.05 to 40.05 GHz	S	
Accuracy (at 23° C ±3° C)	±10 ppm	S	
Stability			
0° to 55° C	±7.5 ppm	C	
Option 1D5	±0.05 ppm	C	
Per year (aging)	±3 ppm	C	
Option 1D5	±0.5 ppm	C	
Resolution	1 Hz	S	
System			
Maximum input level	+5 dBm transmission	S	
	+10 dBm reflection	S	
Damage level (test port)	27 dBm or 0V dc	C	
Trace noise ²			
Magnitude (RMS of peak-to-peak value)			
0.05 to 13.5 GHz	<0.03 dB	C	
13.5 to 20 GHz	<0.04 dB	C	
20 to 40 GHz	<0.15 dB	C	
Phase (RMS of peak-to-peak value)			
0.05 to 13.5 GHz	<0.3°	C	
13.5 to 20 GHz	<0.4°	C	
20 to 40 GHz	<1.5°	C	
Spectral purity			
Harmonics at maximum output level	<-15 dBc	C	
Phase noise			
to 60 kHz from carrier at 2 GHz	<-55 dBc	T	
to 60 kHz from carrier at 20 GHz	<-35 dBc	T	
Nonharmonic spurious signals			
at 100 kHz offset	<-40 dBc	T	
at 200 kHz offset	<-45 dBc	T	
at >200 kHz offset	<-65 dBc	T	

Description	Code
Power	
Power range	
8719ET/8720ET	20 dB C
8722ET	
0.05 to 20 GHz	15 dB C
20 to 40 GHz	10 dB C
Power range (Option 004)	
8719ET/8720ET	75 dB C
8722ET	
0.05 to 20 GHz	70 dB C
20 to 40 GHz	65 dB C
Maximum output power	
8719ET/8720ET	+10 dBm C
8722ET	
0.05 to 20 GHz	0 dBm C
20 to 40 GHz	-5 dBm C
Resolution	
Level accuracy (at 5 dB below maximum output power)	0.01 dB S
8719ET/8720ET	±2 dB S
8722ET	±3 dB S
Power sweep range	
8719ET/8720ET	20 dB S
8719ET/8720ET	30 dB T
8722ET	
0.05 to 20 GHz	15 dB S
8722ET	
0.05 to 20 GHz	25 dB T
8722ET	
20 to 40 GHz	10 dB S
8722ET	
20 to 40 GHz	20 dB T
Power linearity	
-5 dB from reference:	
8719ET/8720ET	±0.35 S
8722ET	
0.05 to 20 GHz	±0.35 S
8722ET	
20 to 40 GHz	±0.60 S
+5 dB from reference:	
8719ET/8720ET	±0.35 S
8722ET	
0.05 to 20 GHz	±0.35 S
8722ET	
20 to 40 GHz	N/A
-10 dB from reference:	
8719ET/8720ET/8722ET	±0.60 S
+10 dB from reference:	
8719ET/8720ET	±1.0 S
8722ET	N/A
Test reference power levels:	
8719ET/8720ET (standard, Option 004)	0 dBm S
8722 ET (standard, Option 004)	-5 dBm S

Frequency range (GHz)

Description	0.05 to 0.84	0.84 to 2	2 to 8	8 to 20	20 to 40	Code
System						
Dynamic range ³						
8719ET/8720ET (standard, Options 004)	102 dB	104 dB	104 dB	104 dB		S
8722D (standard ⁴ , Option 400)	98 dB	102 dB	102 dB	100 dB	89 dB	S
Receiver 0.1 dB compression input level	13 dBm	10 dBm	10 dBm	10 dBm	10 dBm	T

Codes

(S) Specification: warranted performance. Specifications include guardbands to account for expected statistical performance distribution, measurement uncertainties, and changes in performance due to environmental conditions.

(C) Characteristic: a performance parameter that the product is expected to meet before it leaves the factory, but that is not verified in the field and is not covered by the warranty. A characteristic includes the same guardbands as a specification.

(T) Typical (typ.): expected performance of an average unit which does not include guardbands. It is not covered by the product warranty.

(N) Nominal (nom.): a general, descriptive term that does not imply a level of performance. It is not covered by the product warranty.

- Does not apply to 8722ET.
- Trace noise is defined as variation of a high signal level trace due to noise. The value given represents a noise variation that is the RMS of the peak-to-peak value as measured in a 3 kHz IF bandwidth in the fast sweep mode (STEP SWP OFF).
- The dynamic range specifications apply to transmission measurements using 10 Hz IF BW and response and isolation correction or full two-port correction. Dynamic range is limited by the maximum test port power and the receiver's noise floor.
- With 85133E flexible cable on test port.

Measurement throughput summary

Full frequency band sweep time (ms)¹

Measurement	Number of Points			
	51	201	401	1601
	(Swept mode/Stepped mode)			
Single band sweep (10 to 12 GHz)				
Uncorrected	27 / 134	65 / 492	116 / 970	419 / 3836
One-port calibration ²	27 / 134	65 / 492	116 / 970	419 / 3836
Two-port calibration ³	80 / 492	158 / 1034	259 / 2010	866 / 7885
8719E full sweep (0.05 to 13.5 GHz)				
Uncorrected	484 / 597	553 / 1014	614 / 1490	926 / 4336
One-port calibration ²	484 / 597	553 / 1014	614 / 1490	926 / 4336
Two-port calibration ³	996 / 1222	1133 / 2069	1259 / 3057	1876 / 8892
8720E full sweep (0.05 to 20 GHz)				
Uncorrected	449 / 581	538 / 1017	598 / 1490	900 / 4335
One-port calibration ²	449 / 581	538 / 1017	598 / 1490	900 / 4335
Two-port calibration ³	930 / 1192	1106 / 2172	1227 3053	1826 / 8892
8722E full sweep (0.05 to 40 GHz)				
Uncorrected	570 / 731	651 / 1162	707 / 1690	961 / 4519
One-port calibration ²	570 / 731	651 / 1162	707 / 1690	961 / 4519
Two-port calibration ³	1168 / 1162	1333 / 2367	1444 / 3439	1949 / 9269
Time-domain conversion⁴				
	13	42	87	380
	15	41	81	350
GPIB data transfer⁵				
Binary (Internal)	35	15	20	54
IEEE754 floating point format				
32 bit	11	18	26	78
64 bit	13	24	40	134
ASCII	33	105	203	781

1. All values are typical.

2. S11 one-port calibration, with a 6 kHz IF bandwidth. Includes system retrace time. time-domain gating is assumed off.

3. S21 measurement with full two-port calibration, using a 6 kHz IF bandwidth. Includes system retrace time and RF switching time. Time-domain gating is assumed off.

4. Option 010 only, gating and error-correction are off. Does not include sweep time.

5. Measured with an HP Omnibook 7100 266 PentiumII computer.

Options

Agilent 8719ES, 8720ES, and 8722ES Agilent 8719ET, 8720ET, and 8722ET

Time-domain (Option 010)

With the time-domain option, data from transmission or reflection measurements in the frequency domain are converted to the time domain using a Fourier transformation technique (chirp Z) and presented on the display. The time-domain response shows the measured parameter value versus time. Markers may also be displayed in electrical length (or physical length if the relative propagation velocity is entered).

Time stimulus modes

Two types of time excitation stimulus waveforms can be simulated during the transformations, a step and an impulse.

Low-pass step

This stimulus, similar to a traditional time-domain reflectometer (TDR) stimulus waveform, is used to measure low pass devices. The frequency domain data should extend from DC (extrapolated value) to a higher value, the upper limit being defined by the test configuration used. The time-domain response shows the parameter value versus time (multiply by the speed of light, c , to obtain electrical length or by c and V_{rel} to obtain physical length). The step response is typically used for reflection measurements only.

Low pass impulse

This stimulus is also used to measure low-pass devices. The frequency domain data should extend from DC (extrapolated value) to a higher value, the maximum frequency determined by the test configuration. The time-domain response shows changes in the parameter value versus time. The impulse response can be used for reflection or transmission measurements.

Bandpass impulse

The bandpass impulse simulates a pulsed RF signal (with an impulse envelope) and is used to measure the time-domain response of band-limited devices. The start and stop frequencies are selectable by the user to any values within the limits of the test set used. The bandpass time-domain response also shows changes in the parameter values versus time. Bandpass time-domain responses are useful for both reflection and transmission measurements.

Time-domain range

The “alias-free” range over which the display is free of response repetition depends on the frequency span and the number of points. Range, in nanoseconds, is determined by:

$$1/\Delta F = (\text{number of points in frequency domain} - 1) / \text{frequency span (GHz)}$$

Range resolution

The time resolution of a time-domain response is related to range as follows: (for example, 0.3 nanoseconds versus 0.307 nanoseconds)

$$\text{Range} - \text{resolution} = \text{time span} / (\text{number of points} - 1)$$

Distance

Distance is related to time by the speed of light and relative velocity. In space, $V_{rel} = 1$; for distance-to-response in a reflection measurement, multiply by $1/2$. Distance = 3×10^8 m/sec $\times V_{rel} \times$ time

Windows

The windowing function can be used to modify (filter) the frequency-domain data and thereby reduce overshoot and ringing in the time-domain response. Three types of windows are available—minimum, normal, and maximum.

Options, continued

Gating

The gating function can be used to selectively remove reflection or transmission time-domain responses. In converting back to the frequency domain, the effects of the responses outside the gate are removed. The location and span of the gate can be controlled by either setting the center position and time span of the gate, or by setting the start and stop time of the gate.

High-stability frequency reference (Option 1D5)

This option provides the analyzer with ± 0.05 ppm temperature stability from 0 to 60° C (referenced to 25° C).

High-power system (Option 085)

This option is designed to permit the measurement of high-power amplifiers at RF levels up to 20 watts (+43 dBm), with full two-port calibration. A switch is added to the reference path so that booster amplifier response can be ratioed out. To protect the analyzer from high power levels, this option allows the addition of isolators at both test ports and includes internally controlled step attenuators between couplers and samplers. Bias tees, isolators, and booster amplifiers are not included. Network analyzers with Option 085 can also be configured to operate as standard instruments with degraded power accuracy or as instruments capable of making single-connection multiple measurements. Option 085 includes direct access to the samplers (Option 012).

Mechanical transfer switch (Option 007)

This option replaces the solid-state transfer switch with a mechanical switch in the test set, increasing the test port power and dynamic range. Continuous switching is not available in this configuration.

Frequency offset mode (Option 089)

This option adds the ability to offset the source and receiver frequencies for frequency-translated measurements. This provides the instrument with mixer measurement capability. It also provides a graphical setup that allows easy configuration of your measurement.

Direct-access receiver configuration (Option 012)

This option provides front panel access to the A and B samplers for improved receiver sensitivity. Option 012 improves signal-to-noise in free-space materials measurements. Direct connection of the reflection antennas to the A and B samplers eliminates internal reflections of the transmitted signal in the reflection path, improving the signal to noise ratio. Option 012 also allows you to add attenuators between the couplers and samplers, increasing the power handling capability of the instrument.

Fourth sampler and TRL calibration firmware (Option 400)

This option converts the built-in test set to a four-sampler configuration, allowing TRL calibration. This provides the highest accuracy for non-coaxial environments, such as on-wafer probing, and in-fixture or waveguide measurements.

Agilent 8719ET, 8720ET, 8722ET

Step attenuator (Option 004)

Adds a 55 dB step attenuator to extend the minimum source power level by 55 dB.

Time-domain (Option 010)

With the time-domain option, data from transmission or reflection measurements in the frequency domain are converted to the time domain using a Fourier transformation technique (chirp Z) and presented on the display. The time-domain response shows the measured parameter value versus time. Markers may also be displayed in electrical length (or physical length if the relative propagation velocity is entered).

High-stability frequency reference (Option 1D5)

This option provides the analyzer with ± 0.05 ppm temperature stability from 0 to 60° C (referenced to 25° C).

System capabilities

Measurement capabilities

Number of display channels

Four display channels available.

Number of measurement channels

Two primary (independent) and two auxiliary (dependent) measurement channels available.

Parameters

S_{11} : Forward reflection (input match)

S_{21} : Forward transmission (insertion loss/gain/phase)

S_{12} : Reverse transmission (reverse isolation)

S_{22} : Reverse reflection (output match)

A, B, R: Receiver signal level

A/R, B/R, A/B: Ratioed receiver signals

- **Parameter conversion**

- Z – Reflection: equivalent parallel impedance

- Y – Reflection: equivalent parallel admittance

- Z – Transmission: equivalent series impedance

- Y – Transmission: equivalent series admittance

- 1/S: complex inverse of S-parameters

Display formats

- **Cartesian** Log/linear magnitude, phase, group delay, SWR, real, and imaginary.
- **Smith chart** Log/linear magnitude and phase, $R+jX$, $G+jB$, or real/imaginary markers.
- **Polar** Linear/log magnitude, phase, or real and imaginary markers.

Markers

Data markers

Each display channel has five independent markers that can be displayed simultaneously. Twenty independent markers can be displayed in the 4-channel display mode when markers are uncoupled.

Marker control

Discrete (actual measurement points) or continuous (linearly interpolated between points, with 1 Hz resolution).

Delta markers

Displays difference in both stimulus (for example, frequency) and response (for example, dB) between active marker and reference marker.

Polar format markers

Linear magnitude and phase; log magnitude (dB) and phase; real and imaginary.

Smith chart format markers

Linear magnitude and phase; log magnitude (dB) and phase; real and imaginary ($R+jL$); complex impedance ($R+jX$); complex admittance ($G+jB$).

Search

Finds maximum, minimum, or target value.

Bandwidth

Finds and displays center frequency, bandwidth at a user-defined level (for example, -3 dB), Q factor, and shape factor (ratio of 60 dB and 6 dB bandwidths); updates while tuning with tracking enabled.

Statistics

Calculates and displays mean, standard deviation, and peak-to-peak deviation of trace; active between two markers or over entire trace.

Tracking

Performs new search (min/max/target) continuously or on demand.

Marker-to functions

Set start, stop, or center to active marker stimulus values; set span to active and delta marker stimulus values; set reference to active marker response value; set electrical delay to active marker phase response value.

Group delay characteristics

Group delay is computed by measuring the phase change within a specified frequency step (determined by the frequency span, and the number of points per sweep).

Aperture

Selectable. Maximum aperture: 20% of frequency span. Minimum aperture: $(\text{frequency span}) / (\text{number of points} - 1)$.

Range

The maximum delay is limited to measuring no more than 180° of phase change within the minimum aperture. $\text{Range} = 1 / (2 \times \text{minimum aperture})$.

Accuracy

In general, the following formula can be used to determine the accuracy, in seconds, of a specific group delay measurement: $\pm 0.003 \times \text{phase accuracy (deg)} / \text{aperture (Hz)}$.

System capabilities, continued

Internal source control

Sweep limits

Set start/stop or center/span of the stimulus parameter (frequency, power, or time) directly through the source control keys and the control knob, the step keys, or the data entry keyboard.

Sweep type

Set a linear or logarithmic sweep, an arbitrarily defined frequency list, a power sweep, or a CW (single frequency) type of sweep.

Fast swept list

Define up to 30 different subsweep frequency ranges in any combination of CW, CW-delta F, or start-stop sweep modes. Set test-port power levels and IF bandwidth independently for each segment.

Measured number of points per sweep

Linear frequency: choose 3, 11, 21, 51, 101, 201, 401, 801, or 1601 points.

Source coupling

Set a coupled channel sweep (same stimulus conditions on both channels) or an uncoupled channel sweep (independent stimulus conditions).

Chop/alternate sweeps

Select whether to alternately or simultaneously (chop) measure channels when measuring with two-port calibration. Chop mode is faster, while alternate mode optimizes dynamic range. The default is chop mode.

Sweep time

Set sweep time in seconds, minutes, or hours. Minimum sweep time is dependent on number of data points per sweep and selected IF bandwidth.

Auto sweep time

Select auto sweep time by entering zero seconds sweep time. The analyzer will sweep at the minimum sweep time for any subsequently selected stimulus conditions. Auto sweep time is the default condition.

Sweep trigger

Set to either continuous, hold, single, group sweep, or external trigger. Set external trigger to take a complete sweep or to measure individual points in a frequency, power, or list sweep.

Power

Manual or auto source power range selection. Power slope can be set in dBm/GHz.

Power meter calibration

Select continuous leveling or use a correction table to modify source power. The correction table is created with an initial single sweep. Make single or multiple power meter readings at each frequency.

Data accuracy enhancement

Measurement calibration

Measurement calibration significantly reduces measurement uncertainty due to errors caused by system directivity, source and load match, tracking, and crosstalk. Full two-port calibration removes all the systematic errors to obtain the most accurate measurements.

Calibration types available

Frequency response

Simultaneous magnitude and phase correction of frequency response errors for either reflection or transmission measurements.

Response and isolation

Compensates for frequency response and directivity (reflection) or frequency response and crosstalk (transmission) errors.

Enhanced response calibration

Corrects for frequency response and source match for transmission measurements, and provides one-port calibration for reflection measurements.

One-port calibration

Uses test set port 1 or port 2 to correct for directivity, frequency response, and source match errors.

Two-port calibration

Compensates for directivity, source match, reflection frequency response, load match, transmission frequency response, and crosstalk for an S-parameter test set. Crosstalk calibration can be omitted. Available on 8719ES/20ES/22ES analyzers.

TRL*/LRM* calibration

Compensates for directivity, reflection, and transmission frequency response, and crosstalk in both the forward and reverse directions. Especially suitable for calibrating non-coaxial environments, such as in test fixtures. TRL*/LRM* is a special implementation of TRL/LRM calibration, modified for the three-sampler receiver in the standard 8719ES/8720ES/8722ES analyzers.

TRL/LRM calibration

With Option 400 (four-sampler receiver), TRL/LRM provides the highest accuracy for non-coaxial test environments such as in-fixture, on-wafer, or in-waveguide. Compensates for directivity, reflection and transmission frequency response, and crosstalk in both forward and reverse directions. Available as an option on 8719ES/20ES/22ES analyzers.

Interpolated error correction

With any type of accuracy enhancement applied, interpolated mode recalculates the error coefficients when the test frequencies are changed. The number of points can be increased or decreased and the start/stop frequencies can be changed, but the resulting frequency span must be a subset of the original calibration frequency span. System performance is not specified for measurements with interpolated error correction applied.

Set Z_0

Redefine the characteristic impedance of a measurement to a value other than 50 ohms.

Velocity factor

Enter the velocity factor of your propagation medium to convert equivalent electrical length to physical length.

Electrical delay

Add or subtract delay (linear phase slope), up to +10 μ s, similar to "line stretchers," both coax or wave-guide (dispersive) modes. Secondary readout in distance computed from velocity factor.

Reference plane extension

Redefine the reference plane after calibration. A new reference plane is defined in seconds of delay from the test port and ranges between ± 1 seconds. Similar to electrical delay, but applied appropriately to each of four parameters.

Select default calibration kit

Select from a list of standard calibration kits: 7 mm, 3.5 mm, Type-N 50 ohm, 2.4 mm, 7-16, 2.92 mm, and 3.5 mm TRL. You can also define the standards (for example, open-circuit capacitance coefficients, offset short length, or fixed loads) of a user-defined kit.

Segmented calibration

Calibration remains valid for any frequency segment (in frequency list mode), after calibrating all segments with a single calibration.

Receiver power calibration

Adjusts nonratioed receiver inputs to absolute (non-ratioed) power level. Displays absolute power in dBm. Requires reference sweep of known source power.

Data averaging

IF bandwidth

The IF bandwidth is selectable from 6 kHz to 10 Hz to reduce the effective displayed noise floor of the instrument.

Weighted sweep-to-sweep averaging

This function averages vector data on each successive sweep: where $A(n)$ is the current average, $S(n)$ is the current input signal and F is the averaging factor. Averaging factors range from 1 to 999.
$$A(n) = S(n)/F + (1-1/F) \times A(N-1)$$

Trace smoothing

Similar to video filtering, this function computes the moving average of adjacent data points. The smoothing aperture defines the trace width (number of points) to be averaged, and ranges from 0.25% to 20% of the trace width. This function also sets the aperture for group delay measurements.

System capabilities, continued

Display control

Display formats

Single-channel, dual-channel overlay (both traces on one graticule), dual-channel split (each trace on separate graticules), three-channel split (each trace on separate graticules), three-channel overlay (three traces on one graticule), quad-channel overlay (four traces on one graticule), and quad-channel split (each trace on separate graticules).

Trace functions

- **Display data** Display current measurement data, memory data, or current measurement and memory data simultaneously.
- **Trace math** Vector division or subtraction of current real and imaginary pairs. Occurs prior to any formatting or port extensions.

Display annotations

Start/stop, center/span, or CW frequency, source level, scale/div, reference level, marker data, soft-key functions, warning and caution messages, trace identification, and pass/fail indication.

Reference position

Ranges from the 0 (bottom) to 10 (top) graticule position.

Autoscale

Automatically selects scale resolution and reference value to center the trace on the display graticules for easy viewing.

Electrical delay

Offsets measured phase or group delay by a defined amount of electrical delay, in seconds. Operates similarly to an electronic line stretcher. Amount of electrical delay can range between ± 1 seconds.

Frequency blanking

Blanks out all frequency information on the display. Requires an instrument preset to re-enable frequency information on the display.

Title

Add custom titles (49 characters maximum) to the displayed measurement. Titles will be plotted when making hardcopies. Titles can also be used to display operator messages or prompts for a manual adjustment during a test sequence.

Adjust display

Control the intensity and background intensity values of the display. Also, customize the color, value, and brightness of the data traces, memory traces, reference lines, graticules, text, and warning messages. Default colors can be recalled along with one set of user-defined display values. Control is in % of full range.

Save/recall storage

Instrument state

Up to 31 instrument states can be stored internally and recalled via the SAVE/RECALL menu. Instrument states include all control settings, active limit lines, active list frequency tables, memory trace data, active calibration coefficients, and custom display titles. Storage is in non-volatile memory.

Disk drive

Data, instrument states, user graphics, data plots, and test sequences can be stored on internal floppy disk in MS-DOS or Agilent's standard LIF formats.

Data hardcopy

Data plotting

Hard copy plots are automatically produced with HP-GL compatible digital plotters. Data plots can also be stored directly to disk. The 8720ET/ES family provides Centronics, RS-232C, and GPIB interfaces.

Data listings

Printouts of instrument data are directly produced with a printer such as the HP DeskJet or LaserJet. Select black & white or color print. For a list of compatible printers, consult our printer-compatibility guide on the Web at www.agilent.com/find/pcg

Limit lines

Define test limit lines that appear on the display for go/no go testing. Lines may be any combination of horizontal, sloping lines, or discrete data points. Limit test TTL output available for external control or indication.

Operating parameters

Display, print or plot current instrument operating parameters.

Transform

When time-domain (Option 010) is present, this selects the time-domain transform menu.

Instrument mode

Select network analyzer, tuned receiver, or frequency offset mode (Option 089 required).

Tuned receiver

Tunes the receiver for a synthesized CW input signal at a precisely specified frequency. The time bases of the external RF source or sources must be tied to the external reference input of the network analyzer (rear panel BNC). The built-in RF source is not used.

Frequency offset (Option 089 only)

Sets the RF source to be swept at a frequency that is offset from the receiver as required in a swept RF/IF, fixed LO, mixer test. The maximum delay between the RF source and the R-channel input is 0.3 microseconds. Frequency offset mode requires RF and IF frequencies to be within the frequency range of the instrument.

Service menu

Select the desired service test, service diagnostic, service, or verification mode.

Test sequences**Description**

Create, edit, save, or recall a series of front-panel keystrokes to automate a measurement. Each of the six sequence registers can hold approximately 200 instructions. Create or edit a sequence by selecting the sequence menu and then simply performing the front-panel keystrokes that would normally be used to make a manual measurement. Test sequences may contain basic stimulus and measurement functions (frequency, power, parameter, format, scale) advanced operations (time-domain, limit testing, display marker values) and basic logical branching (for example, "IF limit test fails DO sequence 5"). Completed sequences are then saved and can be executed when you are ready to repeat the test.

Storage

Test sequences can be stored internally in RAM, to an internal or external disk drive, or loaded from a computer over the GPIB interface. Sequence 6 is saved in non-volatile storage and can be used as an autostart routine when titled AUTO.

Branching

Branch to another sequence on limit test pass/fail or the loop counter value. Subroutines are also possible via GOSUB.

Other GPIB instruments

Send simple commands to GPIB instruments via the title string.

Test sequence BNC output

Set TTL high or low on the analyzer rear panel output.

General purpose input/output

Read or write bits to the output port to control external devices such as part handlers. Eight output and five input TTL lines are available on the parallel port of the analyzer.

Other functions

Pause/continue, wait, title sequence, print sequence, duplicate sequence, pause, and select.

System capabilities, continued

GPIB (remote) programming

Interface

GPIB interface operates to IEEE 488-1978 and IEC 625 standards and IEEE 728-1982 recommended practices.

Addressing

The GPIB address of the analyzer can be verified or set from the front panel via the local menu and can range from 0 to 30 decimal (factory set at 16).

Pass control

Allows the analyzer to request control of the GPIB (when an active controller is present) whenever it needs to output to a plotter or printer.

System controller

Allows the analyzer to become a controller on the GPIB to directly control a plotter or a printer.

Talker/listener

Allows the analyzer to become a GPIB talker/listener when an external controller is present.

Transfer formats

Binary (internal 48-bit floating point complex format), ASCII, and 32- or 64-bit IEEE 754 floating point format.

User-accessible graphics

Using the HP-GL graphics language, vector or text graphics may be written on the analyzer via GPIB. Up to 5 kbytes of data can be stored at one time (4 bytes per vector, 2 bytes per character).

Interface function codes

SH1, AH1, T6, L4, SR1, RL1, PPO, DC1, DT1, C1, C2, C3, C10, and E2.

Upgrades

Refer to Configuration Guide.

Security

Frequency blank

Blanks all frequency information from display, including markers; requires FACTORY PRESET to re-enable.

Reset memory

Writes binary zeros to all non-volatile memory registers, erasing all instrument state and calibration data; used with PRESET.

General characteristics

Front panel connectors

- **Connector type** 8719/20ET, 8719/20ES: 3.5 mm precision
8722ET/ES: 2.4 mm precision
- **Impedance** 50 ohms (nominal)

Rear panel connectors

- **External reference frequency input (EXT REF INPUT)**
Frequency: 1, 2, 5, and 10 MHz (± 200 Hz at 10 MHz)
Level: -10 dBm to $+20$ dBm, characteristically
Impedance: 50 ohms
- **High-stability frequency reference output (Option 1D5)**
Frequency: 10.0000 MHz
Frequency stability (0° C to 55° C): ± 0.05 ppm
Daily aging rate (after 30 days): $< 3 \times 10^{-9}$ /day
Yearly aging rate: 0.5 ppm/year
Output: 0 dBm minimum
Nominal output impedance: 50 ohm
- **External auxiliary input (AUX INPUT)** Input voltage limits: -10 V to $+10$ V
- **External AM input (EXT AM)** ± 1 volt into a 5 k ohm resistor, 1 kHz maximum, resulting in approximately 8 dB/volt amplitude modulation.
- **External trigger (EXT TRIGGER)** Triggers on a negative TTL transition or contact closure to ground.
- **Test sequence output (TEST SEQ)** This connector outputs a TTL signal which can be programmed by the user in a test sequence to be high or low. By default, this output provides an end-of-sweep TTL signal. (For use with part handlers.)
- **Limit test output (LIMIT TEST)** This connector outputs a TTL signal of the limit test results. Pass: TTL high; Fail: TTL low.
- **Test port bias input (except Option 085 and ET models)**
Maximum voltage: $+ 30$ Vdc
Maximum current (no degradation in RF specifications): ± 200 mA
Maximum current: ± 1 A
- **External monitor: VGA video output** This connector drives external VGA monitors.

Rear panel connectors (continued)

- **GPIB** This connector allows communication with compatible devices including external controllers, printers, plotters, disk drives, and power meters.
- **Parallel port** This connector is used with parallel (or Centronics interface) peripherals such as printers and plotters. It can also be used as a general purpose I/O port, with control provided by test sequencing functions.
- **RS-232** This connector is used with serial peripherals such as printers and plotters.
- **DIN keyboard** This mini-DIN connector is used for the optional AT compatible keyboard for titles and remote front-panel operation.

Internal memory

- **Typical data retention time with 3V, 1.2 Ah battery:**
 - At 25° C: 11,904 days (32.6 years)
 - At 40° C: 1,244 days (3.4 years)
 - At 70° C: 250 days (0.68 year)

Line power

48 to 66 Hz, 115 V nominal (90 V to 132 V) or 230 V nominal (198 V to 264 V), 280 VA max.

Weight

Net: 25 kg (54 lb)

Shipping: 28 kg (61 lb)

Cabinet dimensions

222 mm H x 425 mm W x 457 mm D

(8.75 x 16.75 x 18.0 in) (These dimensions exclude front and rear panel protrusions.)

Ventilation: Allow 100 mm (4 in.) around rear and sides.

Environmental characteristics

General conditions

- **RFI and EMI susceptibility** Defined by VADE 0730, CISPR Publication 11, and FCC Class B Standards.
- **ESD (electrostatic discharge)** Must be eliminated by use of static-safe work procedures and an anti-static bench mat (such as Agilent 92175T).
- **Dust** The environment should be as dust-free as possible.

Operating conditions

- **Operating temperature:** 0° to 55° C
- **Error-corrected temperature range:** ±1° C of calibration temperature
- **Humidity:** 5% to 95% at 40° C (noncondensing)
- **Altitude:** 0 to 4,500 meters (15,000 feet)

Non-operating storage conditions

- **Temperature:** -40° to +70° C
- **Humidity:** 0 to 90% relative at +65° C (noncondensing)
- **Altitude:** 0 to 15,240 meters (50,000 feet)

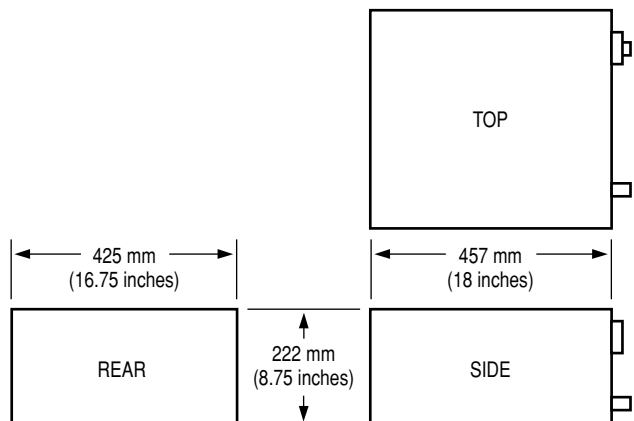

Software

Agilent 85071C materials measurement software

Description

The 85071C software uses broadband S-parameter measurements to determine the electromagnetic properties of dielectric and magnetic materials. The software calculates both the complex permittivity ϵ_r (or dielectric constant) and permeability μ_r , including loss factors. Depending on the network analyzer and fixtures used, measurements can extend from 100 MHz to 110 GHz. The software offers the choice of four algorithms, each designed to address specific measurement needs.

Operating requirements

Standard: requires PC running Windows® 95, 98, or NT® 4.0; >20 MB hard disk space and >4 MB RAM.

Option 300: Substitutes BASIC Software for the standard version for operation with Agilent 9000 Series 300 controllers. Requires BASIC 5.0 or higher and 2 MB of RAM.

Performance summary

Frequency range: 100 MHz to 110 GHz (characteristically, depending on network analyzer, fixture, and material)

Format: ϵ_r' , ϵ_r'' , μ_r' , μ_r'' , $\tan \delta$, or $\tan \delta_m$, or Cole-Cole plots; tabular listings of data.

Stimulus control: Frequency range, number-of-points, and linear or log sweep.

Calibration: The software can use any calibration including a calibrated response gated in the time-domain.

Accuracy: 1 to 2%

Fixture: The software works with simple transmission lines: coaxial airlines, or rectangular waveguide containing a cross-sectional sample of the material-under-test.

Data display: Displays current measurement data, and can save/display 3 memory traces for comparison.

Data storage: Save/recall/export data via disk in Windows®-compatible format.

Agilent 85070C dielectric probe kit

Description

The 85070C dielectric probe kit allows convenient non-destructive testing of materials using the open-ended coaxial probe method. The probe, together with its own dedicated software, determines the complex permittivity of a wide variety of liquids, semi-solids, and solids. Since the probe kit measures only permittivity, only non-magnetic materials should be measured. Measurements are efficient and cost-effective because the testing is non-destructive and there is no need for sample preparation or special fixtures.

Operating requirements

Standard: requires PC running Windows® 95, 98, or NT® 4.0; >20 MB hard disk space and >4 MB RAM.

Option 300: substitutes BASIC software for the standard version for operation with Agilent 9000 Series 300 controllers. Requires BASIC 5.0 or higher and 2 Mbytes of RAM.

Performance summary

Frequency range: 200 MHz to 20 GHz (typical, depending on network analyzer, fixture, and material).

Probe Temperature

Range: -40°C to $+200^\circ\text{C}$

Rate: $<10^\circ\text{C}$ per minute

Format: ϵ_r' , ϵ_r'' , $\tan \delta$, or Cole-Cole diagram in linear format.

Stimulus control: Frequency range, number-of-points, and linear or log sweep.

Calibration: Guided, using open, short (included), and deionized water. Supports user-defined standards.

Accuracy

Dielectric constant, ϵ_r' : $\pm 5\%$

Loss tangent, $\tan \delta$, ϵ_r''/ϵ_r' : ± 0.05

Data display: Displays current measurement data, and can save/display up to three memory traces for comparison.

Data storage: Save/recall/export data via disk in Windows® format.

Accessories

A wide range of accessories support the Agilent 8720E family of network analyzers, including calibration kits, verification kits, cables, and adapters in 7 mm, 3.5 mm, 7-16, Type-N, and 2.4 mm coax and in the standard waveguide bands. The standards used in the 3.5 mm, Type-N, and 2.4 mm calibration and verification kits use precision slotless connectors (PSC-3.5, PSC-N, and PSC-2.4).

Calibration kits

Vector accuracy enhancement procedures require that the systematic errors of the measurement system be characterized by measuring known devices (standards) on the system over the frequency range of interest. Agilent offers the following types of calibration kits:

Standard calibration kits

Standard kits contain open circuits, short circuits, and both fixed and sliding terminations in both sexes for all connector types (except 7 mm, a sexless connector), connector gauges are included in these kits for maintaining each standard's connector interface. Standard calibration kits that include RTL adapters and devices are also available in 7-mm and 3.5-mm connectors.

Precision calibration kits

Precision kits have precision 50 Ω airline(s) for performing the Thru-Reflect-Line (TRL) calibration. These kits also contain the open circuit, short circuit, and fixed terminations used for traditional open-short-load calibration techniques.

Calibration kits

Cal kit type and name	Frequency range (GHz) f_{\min} – f_{\max}	Connector type	Return loss, fixed load	Return loss, sliding load	Return loss, airline at f_{\max}	Residual directivity ² at f_{\max}	Residual source match ² at f_{\max}
Precision							
85052C	0.045 to 26.5	3.5 mm	≥46 dB, DC to 2 GHz	—	50 dB	50 dB	50 dB
Standard							
85050B	0.045 to 18	7 mm	≥52 dB, DC to 2 GHz	≥52 dB, 2 to 18 GHz	—	45 dB	30 dB
85052B	0.045 to 26.5	3.5 mm	≥44 dB, DC to 3 GHz	≥44 dB, 3 to 26.5 GHz	—	44 dB	30 dB
85054B	0.045 to 18	Type-N	≥48 dB, DC to 2 GHz	≥42 dB, 2 to 18 GHz	—	42 dB	30 dB
85056A	0.045 to 50	2.4 mm	≥42 dB, DC to 4 GHz	≥36 dB at 50 GHz	—	38 dB	31 dB
Economy							
85050D	0.045 to 18	7 mm	≥38 dB, DC to 18 GHz	—	—	36 dB	30 dB
85052D	0.045 to 26.5	3.5 mm	≥30 dB at 26.5 GHz	—	—	36 dB	29 dB
85054D	0.045 to 18	Type-N	≥34 dB at 18 GHz	—	—	34 dB	28 dB
85056D	0.045 to 50	2.4 mm	≥26 dB at 50 GHz	—	—	26 dB	23 dB
85056K	0.045 to 40	2.92 mm	≥26 dB at 40 GHz	—	—	25 dB	22 dB
Waveguide							
X11644A ¹	8.2 to 12.4	WR-90	≥42 dB, 8.2 to 12.4 GHz	50 dB	40 dB	30 dB	
P11644A ¹	12.4 to 18	WR-62	≥42 dB, 12.4 to 18 GHz		50 dB	40 dB	30 dB
K11644A ¹	18 to 26.5	WR-42	≥42 dB, 18 to 26.5 GHz		50 dB	40 dB	30 dB
R11644A	26.5 to 40	WR-28	—	46 dB	50 dB	40 dB	30 dB
Electronic							
85060B ³	1 to 18	7 mm	—	—	—	46 dB	40 dB
Option 001	30 kHz to 9	7 mm	—	—	—	45 dB	34 dB
85062B ³	1 to 26.5	3.5 mm	—	—	—	44 dB	37 dB
Option 001	30 kHz to 9	3.5 mm	—	—	—	45 dB	34 dB
85064B ³	1 to 26.5	Type-N	—	—	—	46 dB	40 dB
Option 001	30 kHz to 9	Type-N	—	—	—	47 dB	34 dB

1. Airline return loss, directivity, and source match are typical values for these calibration kits.
 2. Residuals based on 8720E at f_{\max} = 20 GHz for 3.5 mm kits or on 8722E at f_{\max} = 40 GHz for 2.4 mm kits.
 3. Requires an 85097A ECal interface unit.

Accessories, continued

Economy calibration kits

Include the open circuit, short circuit, and fixed termination standards but not sliding terminations or gauges. Gauges can be ordered separately.

Waveguide calibration kits

Contain two coax-to-waveguide adapters with precision flanges, a flush short circuit, a precision waveguide line section, and either sliding or fixed terminations. They support calibration based on TRL/TRL*, offset load, or short/offset-short/load/thru methods.

Agilent 85060 series electronic calibration system

Electronic calibration (ECal) replaces the usual calibration kit standards with a solid-state calibration module. The module is controlled by analyzer firmware via an interface kit to present different impedances to the test ports. A full two-port calibration can be done with a single connection in just a few minutes, with less chance for error and less wear on connectors. An ECal system requires an 85097A interface kit and an 85060 series calibration module. The 85097A includes software for Windows® 95, 98 and NT® 4.0 systems, and is compatible with the 8720C/D/E families. A PC is not needed when using the ECal system with an 8720D/E family analyzer.

Verification kits

Measuring known devices, other than the standards used in calibration, is an easy way to verify the correct operation of an 8720E family network analyzer system. Agilent offers the following verification kits, which contain precision devices with data traceable to NIST, to verify the analyzer's error-corrected measurement performance:

- 85051B 7-mm verification kit; 0.045 to 18 GHz
- 85055A type-N verification kit; 0.045 to 18 GHz
- 85053B 3.5-mm verification kit; 0.045 to 26.5 GHz
- 85057B 2.4-mm verification kit; 0.045 to 50 GHz

Test-port return cables

Test-port cables are available in the 7-mm, 3.5-mm, type-N, and 2.4-mm connectors types. All cables connect directly to the special ruggedized test port of the network analyzer test port (NMD connector). Agilent offers the following cable choices:

- Semi-rigid and flexible single cables
- Semi-rigid and flexible cable sets

A single long cable with an appropriate test port adapter is best for applications where the test device requires a connection next to the test port for mechanical rigidity. A set of cables offers the flexibility required to position the test devices away from the test set.

Semi-rigid cables offer excellent performance and are suitable for applications where the connectors of the test device are “in-line” or parallel. Flexible cables are ideal for manufacturing environments, since they are more rugged and have a tighter bending radius than semi-rigid cables. Semi-rigid cables are warranted for 90 days; flexible cables are warranted for 1 year.

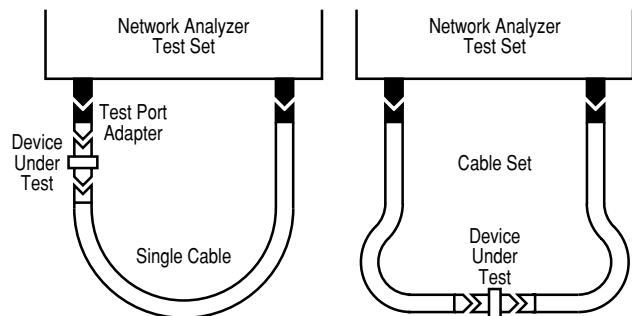

Test port return cable specifications

	Connector Ttype (Test port to device)	Frequency (GHz)	Length ² cm (inch)	Return loss	Insertion loss (dB) (f in GHz)	Stability ^{1,2} ±magnitude	±Phase (degrees)
Single cables for 8719 and 8720 (3.5 mm)							
85131C semi-rigid cable	3.5 mm ³ to PSC-3.5 mm (f)	DC to 26.5	81 (32)	≥17 dB	0.43 √f +0.3 (2.5 dB at f _{max})	<0.06 dB	0.16 (f) +0.5
85131E flexible cable	3.5 mm ³ to PSC-3.5 mm (f)	DC to 26.5	96.5 (38)	≥16 dB	0.35 √f +0.3 (2.1 dB at f _{max})	<0.22 dB	0.16 (f) +0.8
85132C semi-rigid cable	3.5 mm ³ to 7 mm	DC to 18	81 (32)	≥17 dB	0.35 √f +0.3 (1.8 dB at f _{max})	<0.06 dB	0.16 (f) +0.5
85132E flexible cable	3.5 mm ³ to 7 mm	DC to 18	97.2 (38.25)	≥17 dB	0.35 √f +0.3 (1.8 dB at f _{max})	<0.22 dB	0.16 (f) +0.8
Cable sets for 8719 and 8720 (3.5 mm)							
85131D semi-rigid cable set	3.5mm ³ to PSC-3.5 mm (f) or 3.5 mm (m)	DC to 26.5	53 (21)	≥16 dB	0.30 √f +0.2 (1.8 dB at f _{max})	<0.06 dB	0.16 (f) +0.5
85131F flexible cable set	3.5 mm ³ to PSC-3.5 mm (f) or 3.5 mm (m)	DC to 26.5	53 (21)	≥16 dB	0.25 √f +0.2 (1.5 dB at f _{max})	<0.12 dB	0.13 (f) +0.5
85132D semi-rigid cable set	3.5 mm ³ to 7 mm	DC to 18	53 (21)	≥17 dB	0.25 √f +0.2 (1.3 dB at f _{max})	<0.06 dB	0.16 (f) +0.5
85132F flexible cable set	3.5 mm ³ to 7 mm	DC to 18	53 (21)	≥17 dB	0.25 √f +0.2 (1.3 dB at f _{max})	<0.12 dB	0.13 (f) +0.5
Single cables for 8722 (2.4 mm)							
85133C semi-rigid cable	2.4 mm ³ to PSC-2.4 mm (f)	DC to 50	81 (32)	≥15 dB	0.84 √f +0.3 (5.6 dB at f _{max})	<0.06 dB	0.18 (f)
85133E flexible cable	2.4 mm ³ to PSC-2.4 mm (f)	DC to 50	113 (44)	≥12.5 dB	0.58 √f +0.35 (4.45 dB at f _{max})	<0.25 dB	0.8 +0.16 (f)
85134C semi-rigid cable	2.4 mm ³ to PSC-3.5 mm (f)	DC to 26.5	81 (32)	≥16 dB	0.46 √f +0.3 (2.7 dB at f _{max})	<0.06 dB	0.18 (f)
85134E flexible cable	2.4 mm ³ to PSC-3.5 mm (f)	DC to 26.5	97.2 (38.25)	≥16 dB	0.46 √f +0.3 (2.7 dB at f _{max})	<0.22 dB	0.16 (f) +0.8
85135C semi-rigid cable	2.4 mm ³ to 7 mm	DC to 18	81 (32)	≥17 dB	0.46 √f +0.3 (2.25 dB at f _{max})	<0.06 dB	0.18 (f)
85135E flexible cable	2.4 mm ³ to 7 mm	DC to 18	97.2 (38.25)	≥17 dB	0.46 √f +0.3 (2.25 dB at f _{max})	<0.22 dB	0.16 (f) +0.8
Cable sets for 8722D (2.4 mm)							
85133D semi-rigid cable set	2.4 mm ³ to PSC-2.4 mm (f) or 2.4 mm (m)	DC to 50	53 (21)	≥15 dB	0.55 √f +0.2 (4.09 dB at f _{max})	<0.06 dB	0.16 (f)
85133F flexible cable set	2.4 mm ³ to PSC-2.4 mm (f) or 2.4 mm (m)	DC to 50	72 (28)	≥12.5 dB	0.48 √f +0.25 (3.64 dB at f _{max})	<0.17 dB	0.8 + 0.16 (f)
85134D semi-rigid cable set	2.4 mm ³ to PSC-3.5 mm (f) or 3.5 mm (m)	DC to 26.5	53 (21)	≥16 dB	0.31 √f +0.2 (1.8 dB at f _{max})	<0.06 dB	0.18 (f)
85134F flexible cable set	2.4 mm ³ to PSC-3.5 mm (f) or 3.5 mm (m)	DC to 26.5	53 (21)	≥16 dB	0.31 √f +0.2 (1.8B dB at f _{max})	<0.12 dB	0.13 (f) +0.5
85135D semi-rigid cable set	2.4 mm ³ to 7mm	DC to 18	53 (21)	≥17 dB	0.31 √f +0.2 (1.5 dB at f _{max})	<0.06 dB	0.18 (f)
85135F flexible cable set	2.4 mm ³ to 7 mm	DC to 18	62.9 (24.75)	≥17 dB	0.31 √f +0.2 (1.5 dB at f _{max})	<0.12 dB	0.13 (f) +0.5

1. Phase stability of semi-rigid/flexible cables is specified with a 90-degree bend and a 4"/3" radius.

2. Cable length and stability are supplemental characteristics.

3. Special rugged female connector specifically for connecting to the network analyzer test port. Does not mate with a standard male connector.

Accessories, continued

Test port adapter sets

The Agilent 85130 series test port adapter sets protect the test set port when connecting devices to the test port. These adapters, listed below with the single cables, convert the ruggedized test set port to a connection mateable with the device under test. Each set contains a male and a female adapter.

Adapter sets

Adapter set	Connector type (Test port to device)	Frequency (DC– f_{\max})	Return loss at f_{\max}
85130C	3.5 mm ¹ to type-N	DC to 18 GHz	≥28 dB
85130D	3.5 mm ¹ to PSC-3.5 mm (f) or 3.5 mm (m)	DC to 26.5 GHz	≥28 dB
85130E	2.4 mm ¹ to 7 mm	DC to 18 GHz	≥26 dB
85130F	2.4 mm ¹ to PSC-3.5 mm (f) or 3.5 mm (m)	DC to 26.5 GHz	≥26 dB
85130G	2.4 mm ¹ to PSC-2.4 mm (f) or 2.4 mm (m)	DC to 50 GHz	≥23 dB

Equipment rack systems

Agilent 1181B system testmobile

The 1181B System Testmobile is a unit that provides mobility for instruments, test systems, and workstations. It holds units up to 610 mm (24 inches) deep. The load capacity is up to 90 kg (200 lbs) on the tilt tray and 227 kg (500 lb) total. The following accessories are available for the test mobile:

- 35181E anti-static work mat
- 92199B power strip for US and Canada
- 92199E international power strip (IEC-320)

1. Special rugged female connector specifically for connecting to the network analyzer test port. Does not mate with a standard male connector.

Agilent Technologies' Test and Measurement Support, Services, and Assistance

Agilent Technologies aims to maximize the value you receive, while minimizing your risk and problems. We strive to ensure that you get the test and measurement capabilities you paid for and obtain the support you need. Our extensive support resources and services can help you choose the right Agilent products for your applications and apply them successfully. Every instrument and system we sell has a global warranty. Support is available for at least five years beyond the production life of the product. Two concepts underlie Agilent's overall support policy: "Our Promise" and "Your Advantage."

Our Promise

Our Promise means your Agilent test and measurement equipment will meet its advertised performance and functionality. When you are choosing new equipment, we will help you with product information, including realistic performance specifications and practical recommendations from experienced test engineers. When you receive your new Agilent equipment, we can help verify that it works properly and help with initial product operation.

Your Advantage

Your Advantage means that Agilent offers a wide range of additional expert test and measurement services, which you can purchase according to your unique technical and business needs. Solve problems efficiently and gain a competitive edge by contracting with us for calibration, extra-cost upgrades, out-of-warranty repairs, and onsite education and training, as well as design, system integration, project management, and other professional engineering services. Experienced Agilent engineers and technicians worldwide can help you maximize your productivity, optimize the return on investment of your Agilent instruments and systems, and obtain dependable measurement accuracy for the life of those products.



Agilent Email Updates

www.agilent.com/find/emailupdates

Get the latest information on the products and applications you select.

Agilent T&M Software and Connectivity

Agilent's Test and Measurement software and connectivity products, solutions and developer network allows you to take time out of connecting your instruments to your computer with tools based on PC standards, so you can focus on your tasks, not on your connections. Visit **www.agilent.com/find/connectivity** for more information.

For more information on Agilent Technologies' products, applications or services, please contact your local Agilent office. The complete list is available at:

www.agilent.com/find/contactus

Phone or Fax

United States:

(tel) 800 829 4444
(fax) 800 829 4433

Canada:

(tel) 877 894 4414
(fax) 800 746 4866

China:

(tel) 800 810 0189
(fax) 800 820 2816

Europe:

(tel) 31 20 547 2111

Japan:

(tel) (81) 426 56 7832
(fax) (81) 426 56 7840

Korea:

(tel) (080) 769 0800
(fax) (080)769 0900

Latin America:

(tel) (305) 269 7500

Taiwan:

(tel) 0800 047 866
(fax) 0800 286 331

Other Asia Pacific Countries:

(tel) (65) 6375 8100
(fax) (65) 6755 0042

Email: tm_ap@agilent.com

Contacts revised: 9/17/04

Product specifications and descriptions in this document subject to change without notice.

© Agilent Technologies, Inc. 1999, 2001, 2004

Printed in USA, October 19, 2004

5968-5163E



Agilent Technologies