

Agilent 8712B and 8714B RF Economy Vector Network Analyzers

Data Sheet

8712B, 300kHz to 1.3 GHz

8714B, 300kHz to 3.0 GHz

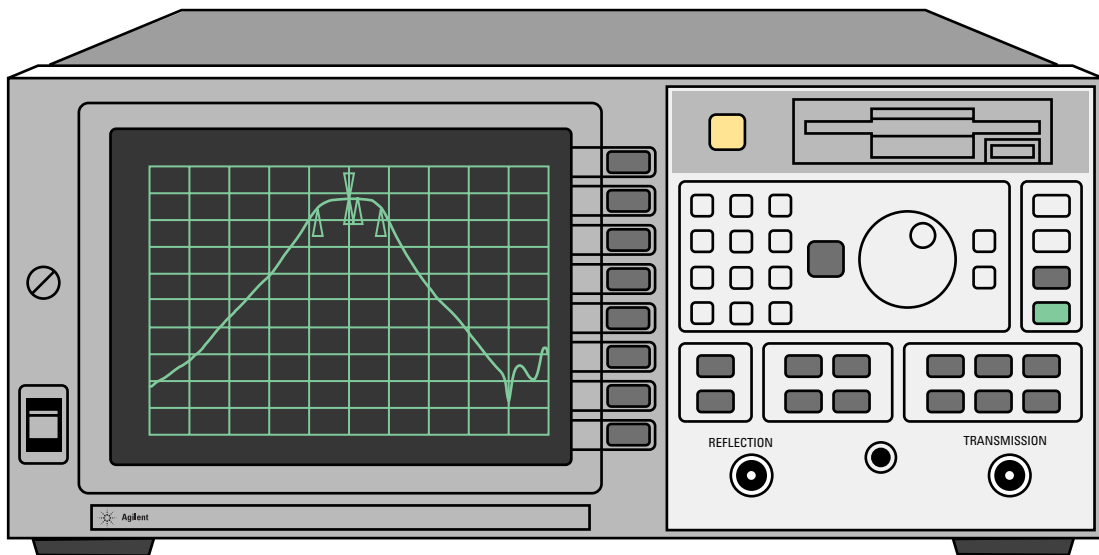

Agilent Technologies

Innovating the HP Way

Specifications

Measurement ports

	8712B	8714B
50 and 75 ohm		
Directivity	40 dB	40 dB
Source match (reflection)	20 dB	20 dB
Source match (transmission)	14 dB typical ¹	23 dB typical at <1.3 GHz, 20 dB typical at >1.3 GHz
Load match	18 dB typical	20 dB typical at <1.3 GHz, 18 dB typical at >1.3 GHz
Reflection Tracking	0 ±0.4 dB typical	0 ±0.2 dB typical

Source

Frequency

Range	300 kHz to 1.3 GHz (8712B) 300 kHz to 3.0 GHz (8714B)
Resolution	1 Hz
Stability	±5 ppm 0° C to 55° C (typical)
Accuracy	1) ±5 ppm at 25° C ±5° C 2) <1 Hz at 10% change in line voltage

Harmonics

<-20 dBc, <1MHz
<-30 dBc, >1MHz for 8712B
<-30 dBc for 8714B

Output Power

Resolution	0.01 dB
Level accuracy	±1.0 dB ±1.5 dB Option 1EC ¹ ±2.0 dB Option 1E1 ±3.0 dB Option 1EC ¹ and 1E1

Maximum and Minimum Power

Options	8712 B				8714B	
	≤1.0 GHz		>1.0GHz		minimum power	maximum power
	minimum power	maximum power	minimum power	maximum power		
No options	0 dBm	16	0	13	-5	10
1E1	-60	15	-60	12	-60	9
1EC ¹	-3	13	-3	10	-8	7
1DA/DB	-2	14	-2	11	-9	6
1E1 and 1EC ¹	-60	12	-60	9	-60	6
1E1 and 1DA	-60	13	-60	10	-60	5
1EC ¹ and 1DB	-5	11	-5	8	-12	3
1EC ¹ , 1E1 and 1DB	-60	10	-60	7	-60	2

This table shows the residual Agilent Technologies 8712B and 8714B system specifications. These characteristics apply at an environmental temperature of 25° ±5° C, with less than 1° C deviation from the calibration temperature. Directivity and source match specifications apply

1. All power specifications with Option 1EC (75 ohms) are typical above 2.0 GHz.

Receiver

Frequency range	8712B	8714B
Narrowband	300 kHz to 1.3 GHz	300 kHz to 3.0 GHz
Broadband	0.10 to 1.3 GHz	0.10 to 3.0 GHz
Dynamic range²		
Narrowband 50 ohm	>100 dB, ≥5 MHz (+10 to -90 dBm) >60 dB <5 MHz (+10 to -50 dBm)	>100 dB (+10 to -90 dBm)
Narrowband 75 ohm	>97 dB, >5 MHz (+10 to -87 dBm) >57 dB, <5 MHz (+10 to -47 dBm)	>97 dB (+10 to -87 dBm)
Broadband 50 ohm	>66 dB (+16 to -50 dBm)	<66 dB (+16 to -50 dBm)
Broadband 75 ohm	>63 dB (+16 to -47 dBm)	>63 dB (+16 to -47 dBm)
Damage level	+23 dBm, +25 VDC	+23 dBm, +25 VDC
Maximum input		
Narrowband (0.5 dB compression)	+10 dBm	+10 dBm
Broadband (0.55 dB compression)	+16 dBm	+16 dBm

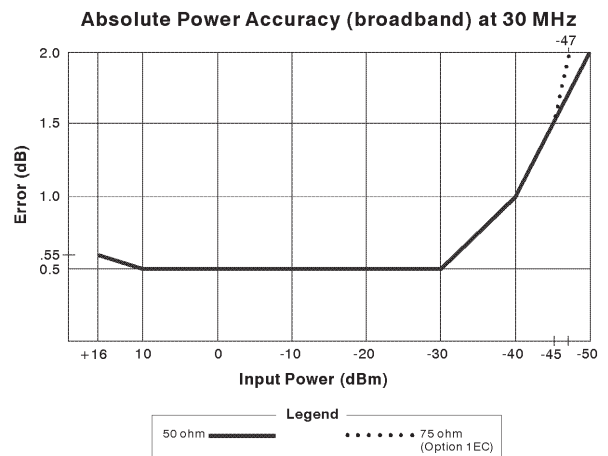
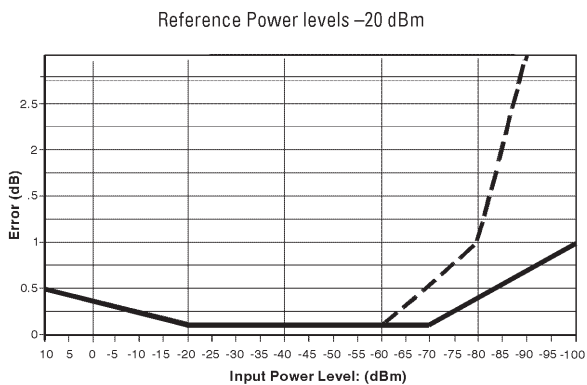

- Receiver dynamic range is calculated as the difference between maximum receiver input level and receiver's noise floor. System dynamic range applies to transmission measurements only, since reflection measurements are limited by directivity. Noise floor is specified as the mean trace noise at specified CW frequencies. A signal at this level would have a signal to noise ratio of 3 dB. Noise floor is measured with test ports terminated in loads, response and isolation calibration, 15 Hz IF bandwidth, 10 dB source power and no averaging.

Group Delay

AM Delay (Option 1DA/1DB)

This option adds amplitude modulation group delay capability, which allows measurements of group delay through frequency-translation devices such as tuners or mixers. Using two external scalar detectors (86200B or 86201B) and a power splitter (all included) this option measures group delay in any device that does not have limiting circuits, saturated amplifiers, or automatic gain control.

Aperture	55.56 kHz
Resolution	1 ns /division
Accuracy³	±4 ns
Delay range	30 μsec. (9000 m)
Amplitude range	-10 to +13 dBm (typical)

Power	Delay
0 to 10 dB	±10 ns
10 to 20 dB	±20 ns

AM Delay Dynamic Accuracy (typical)⁴

Group Delay

Group delay is computed by measuring the phase change within a specified frequency step (determined by the frequency span, and the number of points). This is also known as $d(\phi)/d(\omega)$.

Aperture

Maximum aperture: 20% of frequency span
 Minimum aperture: (frequency span) / (number of points - 1)

Range

The maximum delay is limited to measuring no more than 180° of phase change within the minimum aperture. Range = $1 / (2 \times \text{minimum aperture})$

Accuracy

The following graph shows group delay accuracy at 1.3 GHz with type-N transmission calibration and 15 Hz IF bandwidth. Insertion loss is assumed to be <2 dB and electrical length to be ten meters.

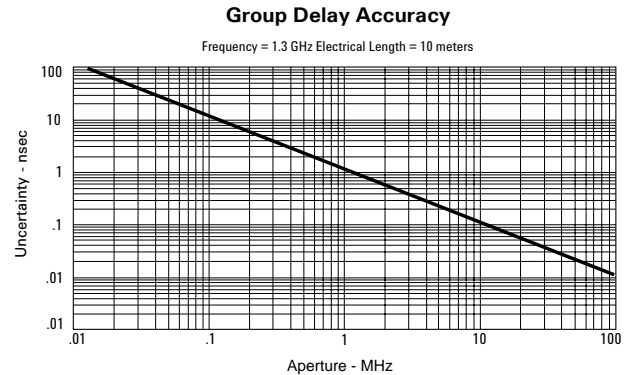

3. Specified at 0 dBm, 16 averages, well-matched device, normalized.

4. Normalized at +10 dBm.

Supplemental Data

Source Signal Purity

Nonharmonic spurious	Agilent 8712B	Agilent 8714B
≥50 kHz from carrier	<-20 dBc, <1 MHz	<-30 dBc
<50 kHz from carrier	<-30 dBc, ≥1 MHz	<-25 dBc
Phase noise (at 10 kHz offset)	-70 dBc/Hz	-67 dBc/Hz
Residual AM (in 100 kHz bandwidth)	<-50 dBc	<-50 dBc
Residual FM 30 Hz to 15 kHz	<1.5 kHz peak	<1.5 kHz peak

Display Characteristics

Amplitude	
Display resolution	0.01 dB/division
Marker reference level	range: ±500 dB resolution: 0.01 dB
Phase	
Range	±180°
Display resolution	0.1°/division
Marker resolution	0.01°
Reference level	range ±360° resolution 0.01°
Polar scale range	1m to 20/division

Typical measurement uncertainty for 8714B at 1.3 GHz

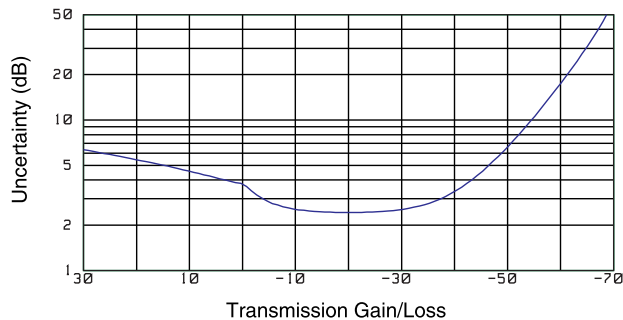
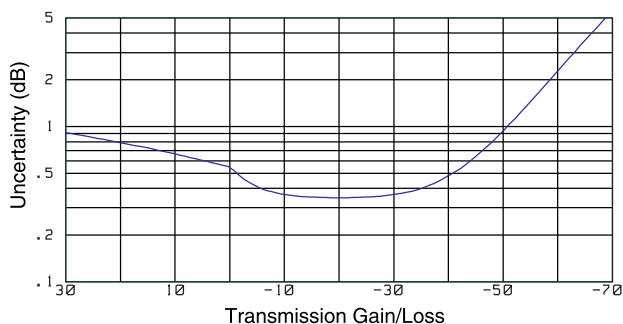

Transmission magnitude uncertainty



Transmission phase uncertainty

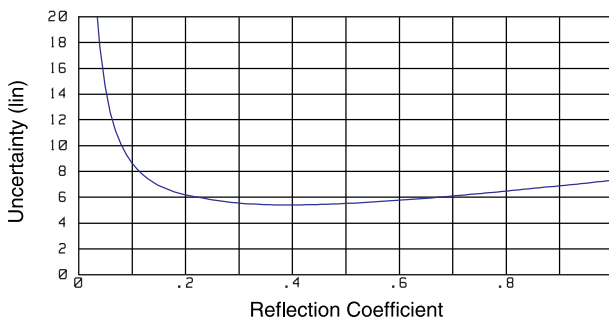

Reflection magnitude uncertainty

Reflection phase uncertainty

These graphs show the measurement uncertainty for the 8714B. The assumptions made to generate these curves were: for transmission uncertainty, $S_{11} = S_{22} = 0.0$; and for the reflection uncertainty, $S_{21} = S_{12} = 0.0$. Reflection tracking = 0.3 dB, transmission tracking = 0.2704 dB (computed from match terms), and trace noise = 0.250 dB. Power = 0 dBm for reflection measurements, and -20 dBm for transmission measurements.

Characteristics

Measurement

Number of display channels

Two display channels are available.

Measurements

- Narrowband: reflection (A/R), transmission (B/R), A, B, R
- Broadband: X, Y, Y/X, X/Y, Y/R*, power (B*, R*), conversion loss (B*/R*)

Formats

- Rectilinear: log or linear magnitude, phase, group delay, SWR, real and imaginary, and dBv, dBmv and dBuv (75 ohm only)
- Smith chart
- Polar

Data markers

Each display channel has eight markers. Markers are coupled between channels. Any one of eight markers can be the reference marker for delta marker operation. Annotation for up to four markers can be displayed at one time.

Marker functions

Markers can be used for various functions: marker search, mkr to max, mkr to min, mkr Δ target, mkr bandwidth and notch. Also with user-defined target values, mkr Δ center, mkr Δ reference, mkr Δ electrical delay are available. The tracking function enables continuous update of marker search values on each sweep. For testing cable TV broadband amplifiers, the slope and flatness functions enable rapid tuning. Marker statistics enable measurement of the mean, peak-to-peak and standard deviation of the data between two markers.

Storage

Internal memory

400 Kbytes of nonvolatile storage is available to store up to 100 instrument states via the save/recall menu. Instrument states can include all control settings, active limit lines, memory trace data, active calibration coefficients, and custom display titles.

Disk drives

Data, instrument states (including calibration data), and IBASIC programs can also be stored on disk, using the built-in disk drive or an external disk drive with command subset CS/80. Data can be stored to disk in MS-DOS (R) format or Agilent's standard LIF format. Data can be stored in binary, PCX, HP-GL or ASCII formats.

Data Hardcopy

Data plotting

Hard copy plots are automatically produced with HP-GL compatible digital plotters such as the Agilent 7475A and compatible graphics printers such as the HP DeskJet or LaserJet (in single color or multi-color format). The analyzer provides Centronics, RS-232C, and GPIB interfaces.

Data listings

Printouts of instrument data are directly produced with a printer such as the HP DeskJet 540 or 560C or PaintJet 3630A (color).

CRT formats

Single-channel, dual-channel overlay (both traces on one graticule) or dual-channel split (each trace on separate graticules).

Trace functions

Display current measurement data, memory data or current measurement with memory data simultaneously. Vector division of current linear measurement values and memory data.

Display annotations

Start/stop, center/span, or CW frequency, scale/division, reference level, marker data, soft key functions, warning and caution messages, titles, clock and pass/fail indication.

Limit lines

Create test limit lines that appear on the display for pass/fail testing. Limits may be any combination of lines or discrete points. Limit test TTL output available for external control or indication. Limit lines are only available in rectilinear formats.

Remote Programming

Interface

GPIB interface operates to IEEE 488.2 and SCPI standard interface commands.

Pass control

Allows the analyzer to request control of the GPIB (when an active controller is present) output to a plotter or printer.

System controller

Lets the analyzer become the controller on the GPIB bus to directly control a plotter or a printer.

Data transfer formats

- Binary (internal 48-bit floating point complex format)
- ASCII
- 32- or 64-bit IEEE 754 floating point format
- Mass memory transfer commands allow file transfer between external controller and analyzer.

Characteristics

Determining Optional Sweep Speed and Dynamic Range

Dynamic range, sweep time and IF Bandwidth are interdependent quantities. Reducing sweep time usually results in a decrease in dynamic range. A compromise must be made depending upon the application. The following charts will help in making these tradeoffs. All data determined from pre-set conditions, except as noted.

Agilent 8714B dynamic range vs IF BW (typical)

IF bandwidth	Narrowband dynamic range
Wide (6500 Hz)	70 dB typical
Medium (3700 Hz)	90 dB typical
Narrow (250 Hz)	105 dB typical
Fine (15 Hz)	110 dB typical

Measurement sweep times (msec)

	8712B		8714B	
	fwd	cycle	fwd	cycle
Medium IF BW	132	159	182	223
Wide IF BW	64	72	118	159
CF = 177 MHz, Span = 200 MHz	51	59	68	87

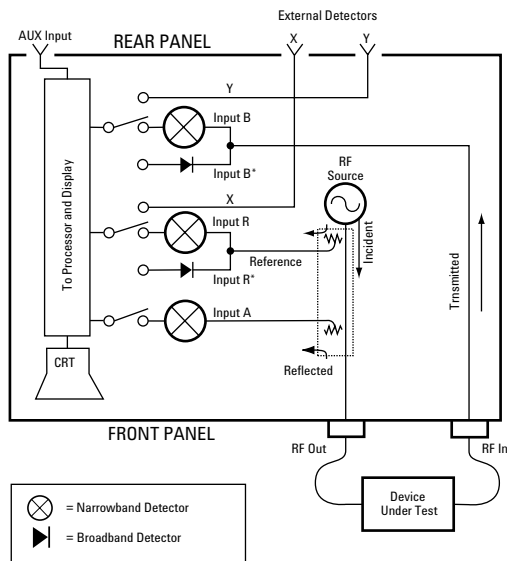

8712B/8713B block diagram

Determining Automated Test Configuration

The following charts are provided to assist in deciding upon system configurations when automating test systems. Typical tradeoffs are between transferring data to an external computer or utilizing the built-in IBASIC capabilities.

Speed of common IBASIC operations (in microseconds)

Operation	Platform	
	871X IBASIC	80486DX 33 MHz
int16 ADD	182	35
int16 SUB	200	36
int16 MUL	219	39
int16 DIV	860	124
float64 ADD	366	94
float64 SUB	346	93
float64 MUL	384	92
float64 DIV	502	95

Trace transfer time (in milliseconds)

Format	Number of points			
	51	201	401	1601
Corrected (Int, 16)	26	31	39	85
Corrected (Real, 64)	32	65	97	330
Corrected (ASCII)	105	364	713	3000
Formatted (Real, 64)	38	59	98	335
Formatted (ASCII)	60	199	390	1510

Entering 8711 data into a BASIC workstation (735/125)

Format	Number of points			
	51	201	401	1601
Corrected (Real, 64)	32	65	97	330
Formatted (Real, 64)	38	59	98	335

Entering data from IBASIC

Format	Number of points			
	51	201	401	1601
Corrected (Int, 16)	28	30	38	102
Corrected (Real, 32)	38	100	182	675
Corrected (Real, 64)	36	90	161	593
Corrected (ASCII)	130	470	923	3600
Formatted (Real, 64)	28	60	102	354
Formatted (ASCII)	75	254	492	1900

Entering 8711 data into a PC (HP Vectra VL2 4/66)

Calibration

Measurement Calibration

Calibration significantly reduces measurement uncertainty due to errors caused by system directivity, source match, reflection tracking and crosstalk. These analyzers reduce systematic errors with a built-in calibration so that measurements can be made on many devices without performing a user calibration. For greater accuracy, especially for special test setups, the analyzers offer one-port reflection calibration to remove reflection errors, a response calibration to remove transmission tracking error and a response and isolation calibration to remove transmission tracking and crosstalk errors.

The interpolated mode recalculates the error coefficients when the test frequencies or the number of points are changed. The resulting frequency span must be equal to or less than the user calibration frequency span. System performance is not specified for measurements with interpolated error correction applied.

Calibrations Available

Transmission measurements

Normalization

Simultaneous magnitude and phase correction of frequency response errors for transmission measurements. Requires a through connection. Used for both narrowband and broadband measurements. Does not support interpolation.

Response

Simultaneous magnitude and phase correction of frequency response errors for transmission measurements. Requires a through connection.

Response and isolation

Compensates for frequency response and crosstalk errors. Requires a load termination on reflection and transmission ports and a through connection.

Reflection measurements

One-port calibration

Calibrates reflection port to correct directivity, tracking and source match errors. Requires an open, short, and load.

Calibration Kits

Data for several standard calibration kits are stored in the instrument for use by calibration routines. They include:

- 3.5 mm (choose 85033C or 85033D)
- type-F 75 ohm (choose 85039A)
- type-N 50 ohm (choose 85032B/E)
- type-N 75 ohm (choose 85036B/E)

In addition you can also describe the standards (for example, open-circuit capacitance coefficients, offset short length, or fixed loads) of a user-defined kit.

The following calibration kits available from Agilent contain precision standards in many different connector types. For further information, consult the *RF Economy Network Analyzer Configuration Guide*, literature number 5962-9928E.

85032B/E 50 ohm type-N calibration kit

Contains precision 50 ohm type-N standards used to calibrate the analyzer to measure devices with 50 ohm type-N connectors. E versions do not contain adaptors or female standards.

85036B/E 75 ohm type-N calibration kit

Contains precision 75 ohm type-N standards to calibrate the analyzer to measure devices with 75 ohm type-N connectors. E versions do not contain adaptors or female standards.

85039A type-F calibration kit

Contains 75 ohm type-F standards to calibrate the analyzer to measure devices with type-F connectors.

85033D Option 001 3.5 mm calibration kit

Contains precision 3.5 mm standards to calibrate the analyzer to measure devices with 3.5 mm or SMA connectors.

Options

Standard Options

75 ohms (Option 1EC)

Provides 75 ohm system impedance.

AM delay (Option 1DA/1DB)

This option adds amplitude modulation group delay capability, which allows measurements of group delay through frequency-translation devices such as tuners or mixers. Using two external scalar detectors (86200B or 86201B) and a power splitter (all included) this option measures group delay in any device that does not have limiting circuits, saturated amplifiers, or automatic gain control.

Option 1DA is for a 50 ohm 8712B or 8714B.

Option 1DB is for a 75 ohm 8712B or 8714B.

IBASIC (Option 1C2)

This option adds a resident BASIC system controller, facilitating automated measurements and control of other devices. Using keystroke recording for the simplest applications, or an optional keyboard to write complex control and calculation programs, IBASIC improves productivity by customizing your measurements.

Step attenuator (Option 1E1)

This option adds a built-in 60 dB step attenuator, extending the source output power low-end range to -60 dBm.

Fault location and structural return loss software (Option 100)

For fully characterizing cable performance, this software package provides *both* fault location and structural return loss. Structural return loss is a special case of return loss measurements. Physical damage of cable, by handling or manufacturing process, causes reflections. Structural return loss occurs when these periodic reflections sum at half-wavelength spacing and reflect the input signal.

Special Options

Switching test sets (Special Option K02)

Switching test sets enhance productivity by allowing multiple measurements with a single connection to the device under test. They are available in several configurations. Please call the factory for more information.

General Characteristics

Front panel connectors

Connector type	type-N female
Impedance	50 ohms (standard) 75 ohms (Option 1EC)
Probe power	+15V 200 mA -12.6V 250 mA

Rear panel connectors

External reference	10 MHz, > -5 dBm, 50 ohm BNC
---------------------------	---------------------------------

Auxiliary input

The auxiliary input measures the DC level at each sweep point. If the slew rate on this input exceeds 700 mV/msec, increased measurement errors will result.

Calibrated range	±10V
Accuracy	±(3 % of reading +20 mV)
Damage level	>15 Vdc

External trigger

Triggers on a negative TTL transition or contact closure to ground.

Limit test output

Provides an open collector TTL high signal. The output is pulled low when the limit test fails.

User TTL input/output

Provides a bi-directional open collector TTL signal that can be accessed by IBASIC.

Video output

Provides an RS-343A compatible multisync video signal. Pixel rate is 33.3 MHz, vertical rate is 60 Hz, and horizontal rate is 24.1 kHz. Output is not compatible with EGA or VGA monitors.

GPIB

Allows communications with compatible devices including external controllers, printers, plotters, disk drives, and power meters.

X and Y external detector inputs

Provides for two external detector inputs. See *Agilent 86200B and 86201B Data Sheet*, literature number 5962-9931E.

Parallel port

This 25-pin female connector is used with parallel (or Centronics interface) peripherals such as printers and plotters. It can also be used as a general-purpose I/O port, with control provided by IBASIC.

RS-232C

This 9-pin male connector is used with serial peripherals such as printers and plotters.

DIN keyboard

This connector is used for adding an IBM PC-AT compatible keyboard for titles, remote front-panel operation, and for IBASIC programming (Option 1C2).

Liner

47 to 60 Hz
115V nominal (90V to 132V) or 230V nominal (198V to 264V) 230 VA max. A three-wire ground is required.

Environmental Characteristics

General conditions

RFI and EMI susceptibility defined by CISPR Publication 11.

ESD (electrostatic discharge) should be minimized by the use of static-safe work procedures and an antistatic bench mat (such as a 92175T).

The sealed flexible rubber keypad protects key contacts from dust, but the environment should be as dust-free as possible for optimal reliability.

Operating environment

Temperature	0° to 55° C
Humidity	5% to 95% at 40° C (noncondensing)
Altitude	0 to 4,500 meters (15,000 feet)

Storage conditions

Temperature	-40° C to +70° C
Humidity	0 to 90% relative at +65° C (noncondensing)
Altitude	0 to 15,240 meters (50,000 feet)

Cabinet dimensions

The following dimensions exclude front and rear panel protrusion:

179 mm H x 425 mm W x 514 mm D
(7.0 in x 16.75 in x 20.25 in)

Weight

Net	20.5 kg
Shipping	30 kg

This document describes the system performance of the 8712B and 8714B 50 ohm and 75 ohm (Option 1EC) network analyzers, and provides two kinds of information:

Specifications describe the instrument's warranted performance over the temperature range of $25^{\circ} \pm 5^{\circ}\text{C}$, unless otherwise stated.

Supplemental characteristics are typical but non-warranted performance parameters. These are denoted as "typical," "nominal" or "approximate."

Test hardware includes the following:

Network analyzer:	8712B or 8714B
Calibration kit:	85032E (50 ohm) 85036E (75 ohm)
Test port cable:	part number 8120-6469 (50 ohm) part number 8120-6468 (75 ohm)

Agilent Technologies' Test and Measurement Support, Services, and Assistance

Agilent Technologies aims to maximize the value you receive, while minimizing your risk and problems. We strive to ensure that you get the test and measurement capabilities you paid for and obtain the support you need. Our extensive support resources and services can help you choose the right Agilent products for your applications and apply them successfully. Every instrument and system we sell has a global warranty. Support is available for at least five years beyond the production life of the product. Two concepts underlie Agilent's overall support policy: "Our Promise" and "Your Advantage."

Our Promise

"Our Promise" means your Agilent test and measurement equipment will meet its advertised performance and functionality. When you are choosing new equipment, we will help you with product information, including realistic performance specifications and practical recommendations from experienced test engineers. When you use Agilent equipment, we can verify that it works properly, help with product operation, and provide basic measurement assistance for the use of specified capabilities, at no extra cost upon request. Many self-help tools are available.

Your Advantage

"Your Advantage" means that Agilent offers a wide range of additional expert test and measurement services, which you can purchase according to your unique technical and business needs. Solve problems efficiently and gain a competitive edge by contracting with us for calibration, extra-cost upgrades, out-of-warranty repairs, and on-site education and training, as well as design, system integration, project management, and other professional services. Experienced Agilent engineers and technicians worldwide can help you maximize your productivity, optimize the return on investment of your Agilent instruments and systems, and obtain dependable measurement accuracy for the life of those products.

By internet, phone, or fax, get assistance with all your test and measurement needs.

Online Assistance

www.agilent.com/find/assist

Phone or Fax

United States:

(tel) 1 800 452 4844

Canada:

(tel) 1 877 894 4414

(fax) (905) 206 4120

Europe:

(tel) (31 20) 547 2323

(fax) (31 20) 547 2390

Japan:

(tel) (81) 426 56 7832

(fax) (81) 426 56 7840

Latin America:

(tel) (305) 267 4245

(fax) (305) 267 4286

Australia:

(tel) 1 800 629 485

(fax) (61 3) 9272 0749

New Zealand:

(tel) 0 800 738 378

(fax) (64 4) 495 8950

Asia Pacific:

(tel) (852) 3197 7777

(fax) (852) 2506 9284

Product specifications and descriptions in this document subject to change without notice.

Copyright © 1995, 2000 Agilent Technologies

Printed in U.S.A. 6/00

5964-0112E



Agilent Technologies

Innovating the HP Way