

**ADVANTEST**

**R3860A RF Component Analyzer  
R3768/3770 Network Analyzer**

New Generation Analyzer Series—World's Fastest\* at 5  $\mu$ s/Point

- Measurement frequency range from 300 kHz to 8 & 20 GHz based on model configuration
- World's fastest sweep rate of 5  $\mu$ s/point
- Model options available for 2 to 4 ports
- System dynamic range of 125 dB (typical)
- Balance measurement at 20 GHz

\*: At August 2003



R3860A/3768/3770

High sweep speed **5  $\mu$ s/point**



# New Generation Analyzer Series Providing Flexible Support



Communications services such as mobile phone and wireless LAN have increased the use of multibands while at the same time terminals are becoming smaller. These trends have led to the widespread use of RF modules combining multiple functions. Also, for existing high-frequency components in conjunction with an even greater miniaturization and more widespread use of balanced circuits, the ability to make increasingly complex measurements more efficiently is a critical goal.

ADVANTEST offers a new generation of analyzers with the flexibility to handle all tasks requiring extreme accuracy, high-speed measurements, and superior analysis functions. The R3860A RF Component Analyzer is a new generation analyzer with the flexibility to measure RF modules that combine multiple functions. Its flexibility extends over a wide range of uses ranging from RF modules that combine multiple functions to frequency conversion circuits and other active components.

The R3768/3770 Network Analyzer is a high-performance multi-port analyzer designed with a greater emphasis on

measuring passive components.

Higher frequencies are also supported, with the R3680A<sup>\*1</sup>/3768 supporting frequencies from 300 kHz to 8 GHz and the R3770 supporting frequencies from 300 kHz to 20 GHz.

All models have the software fixture function that perform real-time simulation of virtual matching circuits and standardized impedance conversion in addition to S-parameter analysis. At the world's fastest high-speed sweep of 5  $\mu$ s/point, simulations of even complex analysis are accomplished instantly. Moreover, multi-port models can perform software balun simulations and balance parameter analysis. If these models are combined and used with the flexible multi-window and multi-trace functions, they can also measure complex analysis items instantly. The large, high-visibility display is a key factor in improving the analysis efficiency because it enables the simultaneous display of multi-port paths in addition to the simultaneous display of fixture simulation traces.

<sup>\*1</sup>: For the R3860A, a 20 GHz specification application package can be selected.

# for RF Hybrid Modules and Multi-port Devices



Frequency range: 300 kHz to 8 GHz (R3860A/3768)  
300 kHz to 20 GHz (R3860A<sup>\*1</sup>/3770)

High-speed sweep: 5  $\mu$ s/point<sup>\*2</sup>

System dynamic range: 125 dB<sup>\*3</sup>

Trace noise: 0.0025 dBrms<sup>\*4</sup>

Output power: +13 dBm<sup>\*5</sup>

Software fixture function: Standard

Built-in test ports: 2, 3, or 4-port<sup>\*6</sup>

Measurement channels: 16

Large-size display: 12.1-inch touch panel LCD

Display windows: 16

Traces: 16 traces/channel

- \*1: For the R3860A, a 20 GHz specification application package can be selected.
- \*2: Sweep time for RBW of 400 kHz
- \*3: Average of eight times at RBW of 10 Hz (typical) when isolation calibration is used. 8 GHz specification: 700 MHz to 3.8 GHz, 20 GHz specification: 700 MHz to 8 GHz
- \*4: 5 MHz to 990 MHz, RBW of 100 kHz (typical)
- \*5: 500 MHz to 4 GHz (two-port model without output attenuator)
- \*6: The number of ports is selected in the application package. For information about the application package, see the ordering information. Main Functions of the R3860A/3768/3770

## R3860A/3768/3770 Major Specifications

|                             | R3860A   | R3768           | R3860A (20 GHz model <sup>*7</sup> )  | R3770           |
|-----------------------------|--|-----------------|---|-----------------|
| Frequency range             | 300 kHz to 8 GHz   |                 | 300 kHz to 20 GHz   |                 |
| Dynamic range <sup>*8</sup> | 300 kHz to 700 MHz: 123 dB<br>700 MHz to 3.8 GHz: 125 dB<br>3.8 GHz to 6 GHz: 124 dB<br>6 GHz to 8 GHz: 123 dB   |                 | 300 kHz to 700 MHz: 123 dB<br>700 MHz to 3.8 GHz: 125 dB<br>3.8 GHz to 6 GHz: 125 dB<br>6 GHz to 8 GHz: 125 dB<br>8 GHz to 20 GHz: 117 dB <sup>*8</sup> |                 |
| Trace noise                 | 300 kHz to 10 MHz: 0.0025 dBrms (1 kHz RBW typical)<br>10 MHz to 990 MHz: 0.0025 dBrms (100 kHz RBW typical)<br>990 MHz to 1.98 GHz: 0.005 dBrms (100 kHz RBW typical)<br>1.98 GHz to 3.96 GHz: 0.010 dBrms (100 kHz RBW typical)<br>3.96 GHz to 8.0 GHz: 0.020 dBrms (100 kHz RBW typical)<br>8 GHz to 15.84 GHz: 0.040 dBrms (100 kHz RBW typical)<br>15.84 GHz to 20 GHz: 0.080 dBrms (100 kHz RBW typical) |                 |   |                 |
| Additional function         |  |                 |   |                 |
| Output attenuator           | ● <sup>*7</sup>  | ● <sup>*7</sup> | ● <sup>*7</sup>   | ● <sup>*7</sup> |
| VSIM <sup>*9</sup>          | ● <sup>*7</sup>  | ● <sup>*7</sup> | ● <sup>*7</sup>   | ● <sup>*7</sup> |
| 2nd SG <sup>*10</sup>       | ● <sup>*7</sup>  | —               | ● <sup>*7</sup>   | —               |
| MIXER <sup>*11</sup>        | ● <sup>*7</sup>  | —               | ● <sup>*7</sup>   | —               |

<sup>\*7</sup>: The symbol ● indicates a function that can be selected from the application package. For details, see the ordering information. <sup>\*8</sup>: The values shown are the typical values for the two-port model.  
<sup>\*9</sup>: VSIM: DC voltage current generator/monitoring function. <sup>\*10</sup>: 2nd SG: 2nd signal source function. <sup>\*11</sup>: MIXER: Vector mixer measuring function

# Automated-Operation Support and Interface with External Equipment

The analyzer provides you with several interfaces that allows connection to a variety of external instruments. The analyzer front panel comes standard with mouse and keyboard connectors, and the rear panel has GPIB, LAN, printer port, and VGA monitor output connectors. In addition, the parallel port built into the analyzer, which is capable of controlling automated equipment without an external controller, provides two channels of 8-bit output ports and two channels of 4-bit inputs and outputs.

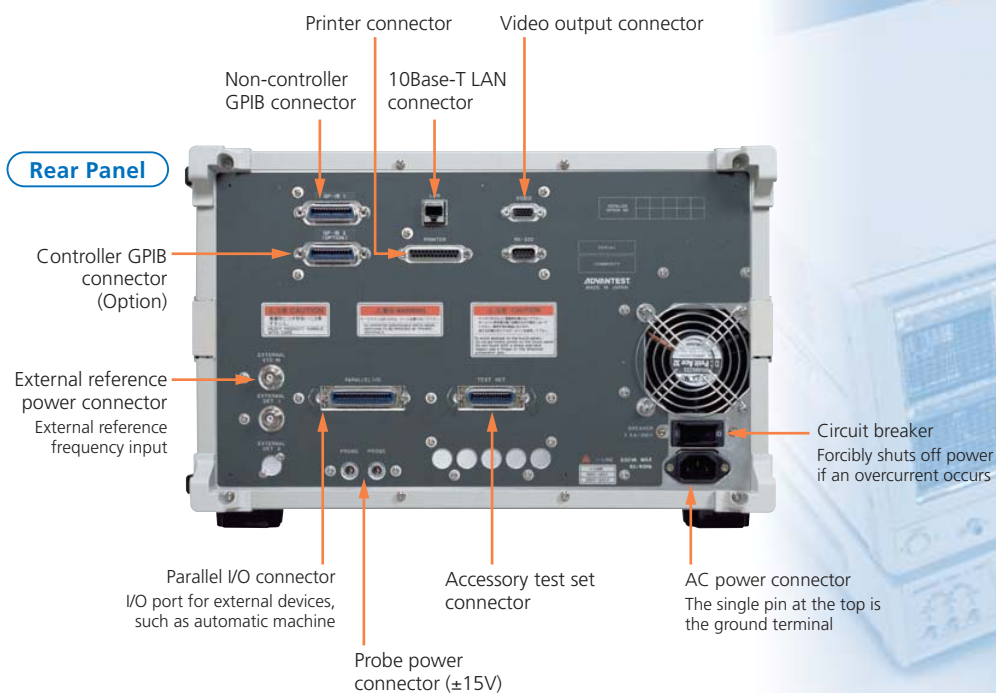
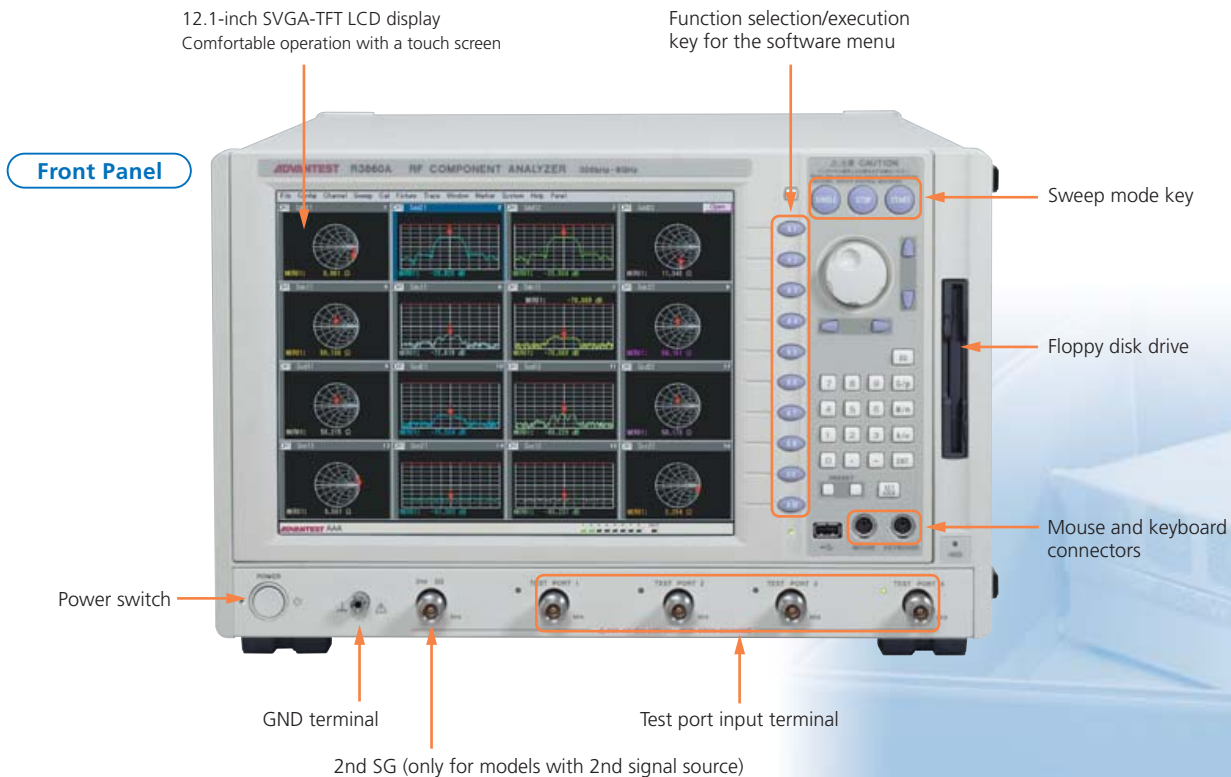

# High-Speed, High-Accuracy High-Frequency Measurements

Incorporating our original analog technology and high-speed operation algorithm, the R3860A RF Component Analyzer and R3768/3770 Network Analyzer provide a system dynamic range of 125 dB (typical). With measurement performance that easily attains the demanding levels of measurements required for filters designed for cell telephone base stations, these analyzers are capable of implementing high dynamic range measurements at high speed. In addition, an improved total throughput precedent is set by the R3860A and R3768/3770 since a wide dynamic range is assured even with the selection of wide-band RBW filters to allow for high measurement speed. Trace noise has also been reduced to half that of the previous ADVANTEST products. Moreover, other features of ADVANTEST analyzers that already perform stable measurements at high speed have been enhanced.

## Outstanding measurement performance

Since a system dynamic range of up to 125 dB (typical) is assured, a greater range of RF components and modules can be measured. Featuring the world's fastest measurement speed of 5  $\mu$ s/point and 16 measurement channels, the analyzers can be used for a wide variety of applications such as design, evaluation, and front-end inspection of modules that incorporate multiple functions.

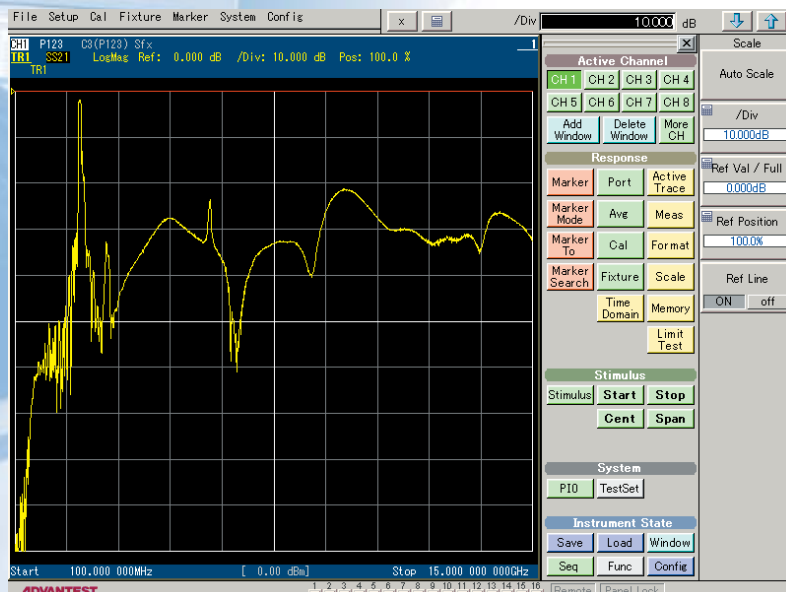
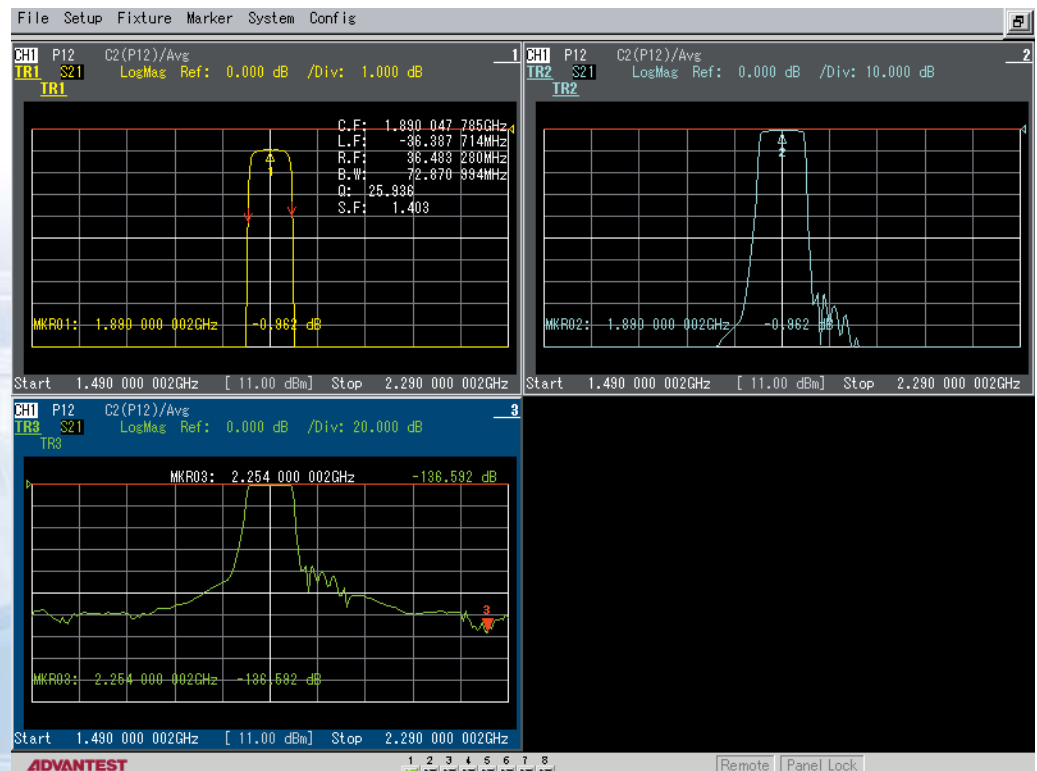

## 20 GHz models operating at upper frequency limits

Despite the higher frequencies being used for wireless LAN communication in the 5 GHz band and standards for measuring higher harmonics for cell telephones, a greater measuring range for wider bands is needed. The R3860A provides an application package whose upper limit frequency has been extended to 20 GHz and is suitable for measuring devices at the demanding standards seen in recent years. (The R3770 also operates at 300 kHz to 20 GHz)

## Sixteen Independent Sweep Channels

### Sixteen independent sweep channels

In addition to setting the frequency range, number of sweep points, and output power, it is possible to set the measurement paths separately, because the 16 sweep channels are fully independent. The status of multiple channels that have been set can be displayed in a dialog box. Adoption of a customizable user interface dramatically improves operability for multi-port devices requiring complex settings.

### Multi-window function for creating up to 16 split windows for analysis

For normal S-parameter analysis, 16 parameters can be analyzed for a four-port device. In addition to the S-parameter analysis, a comprehensive evaluation requires a variety of simulation data, which can be obtained using the software fixture function. When simultaneous analysis of multi-port devices is performed using the multi-port test set, the efficiency of the analysis will improve if more information can be displayed at the same time. This is made possible by the built-in 12.1-inch SVGA large TFT LCD, which can display more analysis results with better visibility, and the multi-window function, which allows a window to be split into as many as 16 split windows.

### Display of up to 16 traces

Because as many as 16 traces can be displayed in a window, more analysis results can be displayed with better visibility and greater efficiency. With this flexibility, it is possible to support a wide variety of measurement environments.

### Multi-port device support

You can option the R3860A/3768/3770 with a test set for full S-parameter measurements of up to four ports. For module devices that have more functions, up to 11 ports are supported after connection of the R3968 multi-port test set (option).

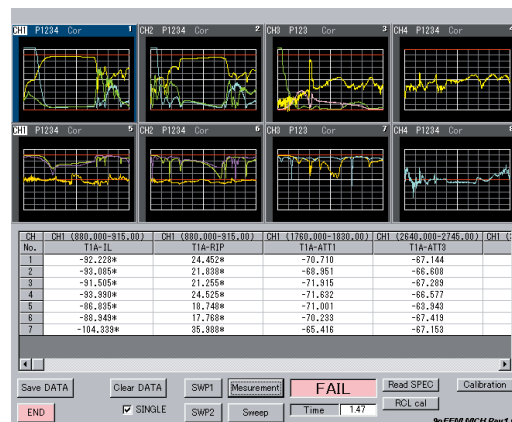

16-channel sweep screen

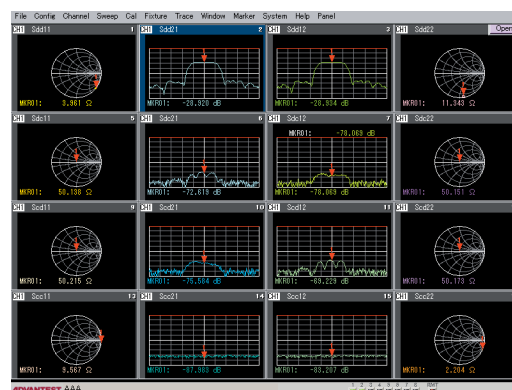

16-trace window display screen



# Software Fixture

The widespread use of balanced input/output devices has increased the demand for a software fixture function that simulates virtual fixtures. During the inspection process on a production line, measuring speed is of primary importance. On the other hand, in the relationship between circuit designers, parts makers and end users, high analysis efficiency is equally important. ADVANTEST's software fixture is provided as standard function on all models to address these requirements.

## Matching Network

### ADD circuit

Characteristics obtained by virtual addition of a matching circuit to the measuring port can be simulated in real time. You can easily calculate matching condition changes by entering the topology of components and constants directly from the keyboard. For cases when a more complex matching circuit is added, you can read the S-parameter file externally.

### Delete circuit

As higher and higher frequencies are used, error sources between the calibration reference surface of the calibration kit and the object to be measured have a greater adverse effect on measurement results. A delete circuit can remove the predefined error sources as an S-parameter file.

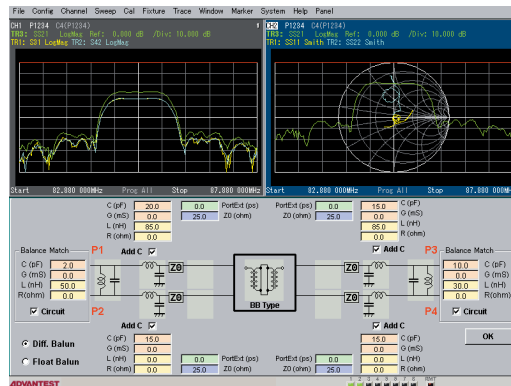

Example of software fixture settings  
(The figure shows an example of the measurement using MDAS-PRO.)

## Impedance Conversion

This function is used for measurement of devices with an impedance other than the standardized  $50\Omega$  characteristic impedance. Since it is possible to convert to any impedance, measurement flexibility extends to a wide range of devices.

## Balance Analysis

### Software Balun

Simulation of an ideal balun enables a balanced circuit to be replaced with unbalanced parameters. Defined as SS11, SS21, SS22, and SS12, the converted parameters are used, regardless of the number of device ports, as parameters for the forward transmission/reflection and backward transmission/reflection of measurement objects. This allows an instantaneous calculation of more intuitive analysis results.

### Balance parameter

This parameter enables intuitive analysis of how close a balanced circuit is to its ideal value. When the balance parameter is measured, different unbalanced S-parameters can be displayed. This allows for the intuitive analysis of whether the balance is matched, without the need for a comparison procedure.

## Mode Analysis

The S-parameter in each mode is analyzed by separately focusing on the common mode and the differential mode for input/output of a balanced circuit. Analysis of signals in each mode is especially important in the evaluation of circuits in which balanced components are connected. In combination with the multi-trace function, the parameters in each mode can be entered for a wide variety of layouts.

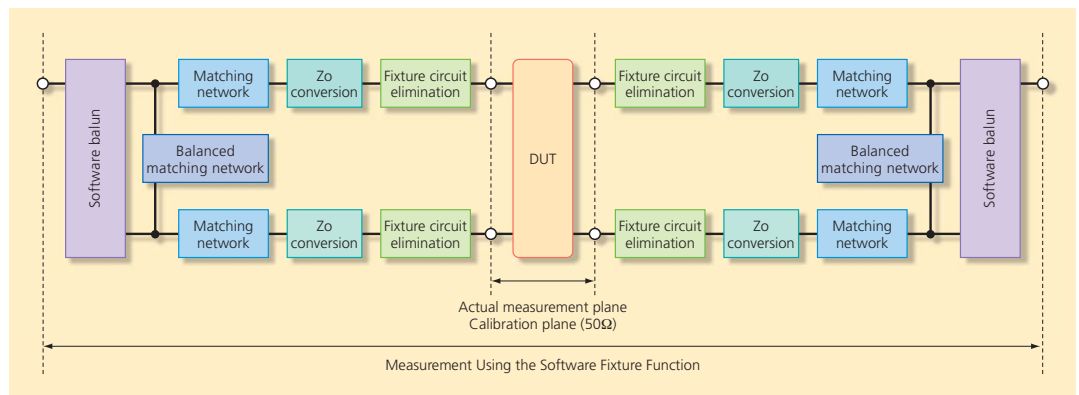

Block diagram of the software fixture function

## Multiple ports

Increasing use of multi-band cellular phones and balanced receiving circuits has led to a rapidly rising demand for multi-port measurements. The R3968 multi-port test set provides up to 11 ports in support of triple-band and quad-band balanced devices. Multi-port measurements require flexible analyzer settings, such as for different paths and different frequency ranges. A wealth of functions that improve total throughput with 16 channels and 16 windows provides flexibility for the handling of a wide variety of devices.

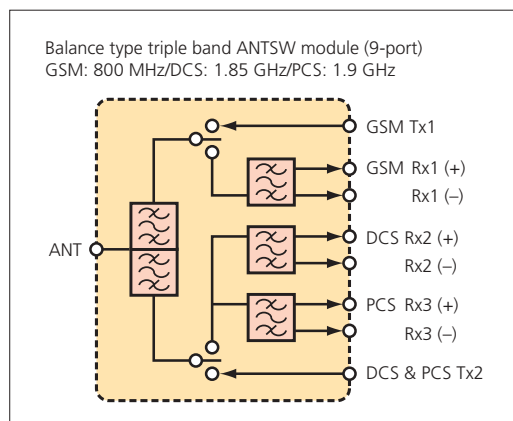

Example of a triple-band antenna switch module

### Per-port architecture

A per-port architecture that has a receiver and bridge for each measuring port is used as the measurement mode for the multiple ports built into the R3860A/3768/3770. In the 4-port model, a reference channel and four measuring channels makes it possible to obtain 16 parameters in four sweeps. With this architecture, the number of sweeps required for a multi-port device is significantly less, reducing measuring time.

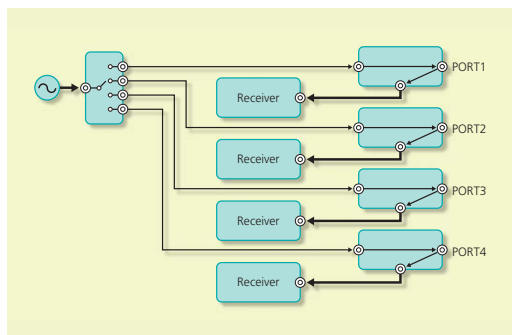

Block diagram of the per-port architecture

### Multi-port test set that measures up to 11 ports (option)

The R3968 multi-port test set can be used with the R3860A/3768/3770 to measure transmission and reflection characteristics of multi-port devices that have up to 11 ports. This combination is optimal for measuring such multi-port devices as dual-band couplers and triple-band antenna switch modules. Furthermore, general purpose application programs (see MDAS) written in Visual Basic are provided, dramatically reducing the amount of labor required during program development.



Combination with the R3968 multi-port test set



R17051A/17052A automatic calibration kit



# MDAS (Multi-Device Application Software) \*1

As measurement conditions become more complex in the balance analysis of balanced circuits and measurement of multi-port devices, more and more conditions need to be set for measurements with an analyzer. In contrast to the program sweep function and preset technical standard values used to reconcile high-speed and high-accuracy measurements, a limit-line function that provides pass/fail evaluation results is more appropriate for general-purpose measurements. However, the analyzer operating load increases with this approach, as the data that needs to be set becomes more diverse. The MDAS function, developed in the Visual Basic environment, is general-purpose application software that enables easy measurements under complex conditions in four steps.

## STEP 1 Creating and editing a type file

Items such as the number of ports of the object being measured, whether balance analysis is used, matching circuit settings, frequency segments, analysis items, technical standard values, and method of control signal output to external devices are easy to create and edit as a CSV file. If complex condition settings are required, the operator can choose among complex-key operations of the analyzer, greatly improving measurement efficiency.

MDAS-PRO \*2 uses a graphical user interface to make it easier for the user to set the balanced input/output port and matching circuit topology. The result is a significant reduction in time needed to set the analyzer before measurements are made.

|     |                                      |                |               |                             |              |   |
|-----|--------------------------------------|----------------|---------------|-----------------------------|--------------|---|
| CH2 | CH Title                             | DC:SW          |               |                             |              |   |
|     | SaveRefMag                           | 102            |               |                             |              |   |
|     | Port Selection                       | P1234          |               |                             |              |   |
|     | DevicePort Selection                 | UD34           |               |                             |              |   |
|     | PRO CV Sync Control                  | 150            | 2nd           |                             |              |   |
|     | PRO PORT OUTPUT                      | 2              | 0             |                             |              |   |
|     | SubFunctionFunctionOff               | ON             |               |                             |              |   |
|     | Setting of each port                 | PORT1          | PORT2         | PORT3                       | PORT4        |   |
|     | Port Extension (post)                | 140            | 140           | 140                         | 140          |   |
|     | Port Impedance (oh)                  | 50             | 50            | 25                          | 25           |   |
|     | PCB6 Port Adapter                    | A              | B             | B                           | B            |   |
|     | Add Circuit Type                     | LPCSD          | LPCSD         | LPCSD                       | LPCSD        |   |
|     | Cap CFI                              | 0              | 0             | 0                           | 0            |   |
|     | Cap GSD                              | 0              | 0             | 0                           | 0            |   |
|     | Ind LRF                              | 0              | 0             | 0                           | 0            |   |
|     | Ind RRF                              | 0              | 0             | 0                           | 0            |   |
|     | Balance Parameter (on/off)           | ON             |               |                             |              |   |
|     | Basic Type (OFF FOR INITIAL/LOADING) | OFF            |               |                             |              |   |
|     | Mode Analysis (OFF/LOADING/SCIP/S)   | OFF            |               |                             |              |   |
|     | Balance Port Future                  | Balance Port1  | Balance Port2 |                             |              |   |
|     | Add Circuit Type                     | CPLPD          | CPLPD         |                             |              |   |
|     | Cap CFI                              | 0              | 0             |                             |              |   |
|     | Cap GSD                              | 0              | 0             |                             |              |   |
|     | Ind LRF                              | 0              | 0             |                             |              |   |
|     | Ind RRF                              | 0              | 0             |                             |              |   |
|     | Number of Freq Segment               | 1              |               |                             |              |   |
|     | Freq Stop No.                        | START(MHz)     | STOP(MHz)     | POINT                       | POWER(dBm)   |   |
|     | Number of Trace                      | 1              | 500           | 6000                        | 401          | 0 |
|     | Trace Number                         | Meas           | FORMAT        | DIV                         | Ref VAL      |   |
|     |                                      | 1              | S12           | LOGMAG                      | 10           | 0 |
|     |                                      | 2              | S22           | SWR                         | 1            | 1 |
|     |                                      | 3              | S321          | LOGMAG                      | 10           | 0 |
|     | Number of Measurement                | 4              |               |                             |              |   |
|     | Seq. No.                             | TITLE          | Sweep         | Judge Valid(ON/Invalid/OFF) | Trace Number |   |
|     | 1                                    | DCS TX L       | 1             | ON                          |              |   |
|     | 2                                    | DCS TX ATT     | 1             | ON                          |              |   |
|     | 3                                    | DCS TX 2B      | 1             | ON                          |              |   |
|     | 4                                    | DCS TX 2B      | 1             | ON                          |              |   |
|     | 5                                    | DCS TX -DCS Rx | 1             | OFF                         |              |   |
|     | 6                                    | DCS TX VSWR    | 1             | ON                          |              |   |

Example of creating a type file

## STEP 2 Selecting the measurement type file

A type file created in advance can be selected to instantly make all the settings. It is also possible to centrally control the type settings of production processes from a host computer connected via LAN.

## STEP 3 Calibration

Settings made using the graphical calibration menus prevent incorrect connections in a complex calibration procedure. Only calibration types suitable for the selected type are displayed for selection. The software has also a function that carries out calibration by reading calibration data acquired in advance.

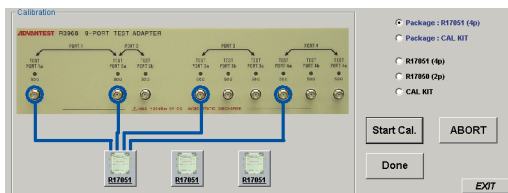

Graphical calibration setting

## STEP 4

### Measurement, analysis, and saving of data

It is possible not only to save pass/fail evaluation results and measured data in a CSV file, but also to save in a TS file specific trace data specified using the mouse. Work efficiency therefore improves over a wide range of operations, from continuous measurement in the production line to device evaluations in the design stage.



Example of pass/fail evaluation of a multi-port device used for communication

\*1: The MDAS application software is a sample program written in Visual Basic.

\*2: MDAS-PRO is a function that can be selected from the application package.

## Nonlinear Analysis

In addition to the signal source for sweeps, you can add a second signal source, extending the uses of the analyzer. Because both the two signals and the frequency range in the receiving section can be controlled independently, new measuring methods can be applied for the measurement of filter harmonics.



### Second signal source function (R3860A\*)

A signal source that is independent of the signal source for network analysis can be included in the original WMT platform. The addition of a second signal provides a still wider range of measurement targets, including mixers and other nonlinear devices and bandpass filter harmonics.

### Mixer measurement (R3860A\*)

Controlling the phase of the second signal source so that it is completely a local signal source allows mixer characteristics to be measured with vector values to a high degree of accuracy. You can select Sweep, Fixed, or Auto mode as the local signal for the signal output from the second signal source. Also, the frequency sweep of the receiving section is easy to set from the mixer measurement dialog box. Mixer measurement is a special feature of a component analyzer that can handle any measurement object on its own without the need for an external signal generator.

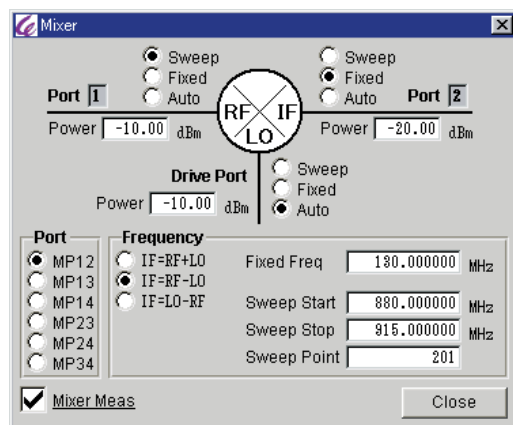

Dialog box for mixer measurement settings

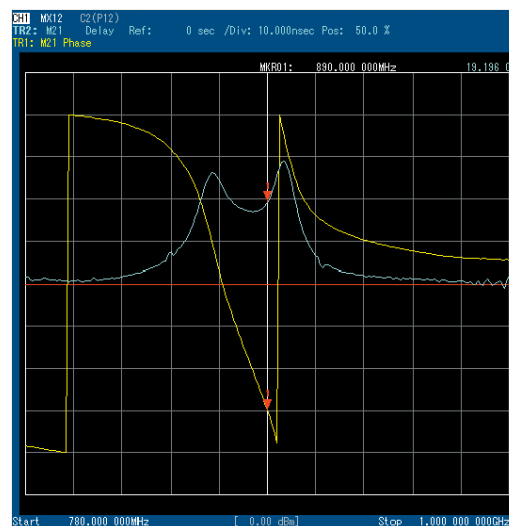

Measurement sample for combined circuit of mixer and filter

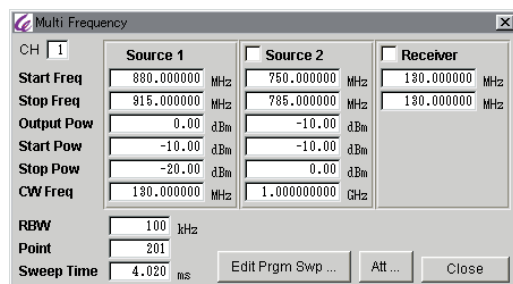

Multi-Frequency function setting

### Multi-Frequency function\*\*

A function is built in that enables you to set independently the frequency ranges of the signal source, second signal source, and the receiving section. This enables harmonic measurement when a signal enters the basic waveband of a filter. Availability of this function also means that an external signal generator and a spectrum analyzer are not needed, which lowers design evaluation and production process costs.

\*1: A function available in the application package provided by R3860A with the second SG installed.

\*2: In the R3860A, this function is installed as standard. In the R3768/3770, this function can be selected from the application package.

## Option Package Configuration

### R3860A 8/20 GHz RF Component Analyzer

| Package code     | Application name                                  | Hardware |        |        |        |        | Additional options |        |         |      | Software   |          |
|------------------|---|----------|--------|--------|--------|--------|--------------------|--------|---------|------|------------|----------|
|                  |   | 8 GHz    | 20 GHz | 2-port | 3-port | 4-port | ATT                | 2nd SG | 2nd ATT | VSIM | Multi-freq | MDAS-PRO |
| R3860A-0200-1000 | 8 GHz 2-port model                                | ●        | –      | ●      | –      | –      | –                  | –      | –       | –    | Standard   | –        |
| R3860A-0202-1000 | 8 GHz 2-port model for non-linear passive device  | ●        | –      | ●      | –      | –      | –                  | ●      | –       | –    | Standard   | –        |
| R3860A-0209-1000 | 8 GHz 2-port model for active device              | ●        | –      | ●      | –      | –      | ●                  | –      | –       | ●    | Standard   | –        |
| R3860A-020F-1000 | 8 GHz 2-port model for non-linear active device   | ●        | –      | ●      | –      | –      | ●                  | ●      | ●       | ●    | Standard   | –        |
| R3860A-0300-1000 | 8 GHz 3-port model                                | ●        | –      | –      | ●      | –      | –                  | –      | –       | –    | Standard   | –        |
| R3860A-0400-1010 | 8 GHz 4-port model                                | ●        | –      | –      | –      | ●      | –                  | –      | –       | –    | Standard   | ●        |
| R3860A-0402-1010 | 8 GHz 4-port model for non-linear passive device  | ●        | –      | –      | –      | ●      | –                  | ●      | –       | –    | Standard   | ●        |
| R3860A-0409-1010 | 8 GHz 4-port model for active device              | ●        | –      | –      | –      | ●      | ●                  | –      | –       | ●    | Standard   | ●        |
| R3860A-040F-1010 | 8 GHz 4-port model for non-linear active device   | ●        | –      | –      | –      | ●      | ●                  | ●      | ●       | ●    | Standard   | ●        |
| R3860A-1200-1000 | 20 GHz 2-port model                               | –        | ●      | ●      | –      | –      | –                  | –      | –       | –    | Standard   | –        |
| R3860A-1202-1000 | 20 GHz 2-port model for non-linear passive device | –        | ●      | ●      | –      | –      | –                  | ●      | –       | –    | Standard   | –        |
| R3860A-1300-1000 | 20 GHz 3-port model                               | –        | ●      | –      | ●      | –      | –                  | –      | –       | –    | Standard   | –        |
| R3860A-1400-1010 | 20 GHz 4-port model                               | –        | ●      | –      | –      | ●      | –                  | –      | –       | –    | Standard   | ●        |
| R3860A-1402-1010 | 20 GHz 4-port model for non-linear passive device | –        | ●      | –      | –      | ●      | –                  | ●      | –       | –    | Standard   | ●        |

### R3768 8 GHz Network Analyzer

| Package code    | Application name               | Hardware |   |        |        |        | Additional options |        |         |      | Software   |          |
|-----------------|--------------------------------|----------|---|--------|--------|--------|--------------------|--------|---------|------|------------|----------|
|                 |                                | 8 GHz    | – | 2-port | 3-port | 4-port | ATT                | 2nd SG | 2nd ATT | VSIM | Multi-freq | MDAS-PRO |
| R3768-0200-1000 | 2-port model                   | ●        | – | ●      | –      | –      | –                  | –      | –       | –    | –          | –        |
| R3768-0201-1001 | 2-port extend power model      | ●        | – | ●      | –      | –      | ●                  | –      | –       | –    | ●          | –        |
| R3768-0300-1000 | 3-port model                   | ●        | – | –      | ●      | –      | –                  | –      | –       | –    | –          | –        |
| R3768-0400-1010 | 4-port model                   | ●        | – | –      | –      | ●      | –                  | –      | –       | –    | –          | ●        |
| R3768-0401-1011 | 4-port extend power model      | ●        | – | –      | –      | ●      | ●                  | –      | –       | –    | ●          | ●        |
| R3768-0408-1011 | 4-port model for switch module | ●        | – | –      | –      | ●      | –                  | –      | –       | ●    | ●          | ●        |

### R3770 20 GHz Network Analyzer

| Package code    | Application name               | Hardware |        |        |        |        | Additional options |        |         |      | Software   |          |
|-----------------|--------------------------------|----------|--------|--------|--------|--------|--------------------|--------|---------|------|------------|----------|
|                 |                                | –        | 20 GHz | 2-port | 3-port | 4-port | ATT                | 2nd SG | 2nd ATT | VSIM | Multi-freq | MDAS-PRO |
| R3770-0200-1000 | 2-port model                   | –        | ●      | ●      | –      | –      | –                  | –      | –       | –    | –          | –        |
| R3770-0300-1000 | 3-port model                   | –        | ●      | –      | ●      | –      | –                  | –      | –       | –    | –          | –        |
| R3770-0400-1010 | 4-port model                   | –        | ●      | –      | –      | ●      | –                  | –      | –       | –    | –          | ●        |
| R3770-0408-1011 | 4-port model for switch module | –        | ●      | –      | –      | ●      | –                  | –      | –       | ●    | ●          | ●        |

## Accessories

### Automatic Calibration Kit

| Model number | Frequency range   | Number of ports | Connector | Pole   |
|--------------|-------------------|-----------------|-----------|--------|
| R17051A + 02 | 300 kHz to 8 GHz  | 2-port          | 3.5 mm    | female |
| R17051A + 04 | 300 kHz to 8 GHz  | 4-port          | 3.5 mm    | female |
| R17051A + 22 | 300 kHz to 8 GHz  | 2-port          | N type    | female |
| R17051A + 24 | 300 kHz to 8 GHz  | 4-port          | N type    | female |
| R17052A + 02 | 300 KHz to 20 GHz | 2-port          | 3.5 mm    | female |
| R17052A + 04 | 300 KHz to 20 GHz | 4-port          | 3.5 mm    | female |

### Calibration Kit

| Model number | Frequency range | Connector | Pole         |
|--------------|-----------------|-----------|--------------|
| Model 9617A3 | DC to 18 GHz    | N type    | female, male |
| Model 9617F3 | DC to 18 GHz    | 3.5 mm    | female, male |
| A170003      | DC to 26.5 GHz  | 3.5 mm    | female       |
| A170004      | DC to 26.5 GHz  | 3.5 mm    | female, male |
| A170005      | DC to 18 GHz    | N type    | female       |
| A170006      | DC to 18 GHz    | N type    | female, male |

## Main Performance Specifications

The item with specification of 8 GHz model is applied to an R3860A 8 GHz model and R3768.

The item with specification of 20 GHz model is applied to an R3860A 20 GHz model and R3770.

### Measurement functions

|                                  |  |
|----------------------------------|--|
| Measurement channels:            | 16   |
| Display window:                  | 16   |
| Trace:                           | 16 traces/channel<br>(Max. 16 traces: Simultaneous display)  |
| Measurement parameters           |  |
| 2-port model:                    | S11, S21, S12, S22   |
| 3-port model:                    | S11, S22, S33, S21, S12, S31, S13, S23, S32  |
| 4-port model:                    | S11, S22, S33, S44, S21, S31, S41, S12, S32, S42, S13, S23, S43, S14, S24, S34<br>Conversion to impedance (Z) and admittance (Y) is possible by the parameter conversion function. |
| Measurement format               |  |
| Rectangular-coordinates display: | Amplitude (linear/log), Phase, Group-delay, VSWR, Complex number (real/imaginary)  |
| Smith chart:                     | Marker reading is linear/logarithmic amplitude, Phase, and a complex number (real/imaginary)<br>R + jX, G + jB   |
| Polar coordinates display:       | Marker reading is linear/logarithmic amplitude, Phase, and a complex number (real/imaginary)   |

### Signal source characteristics

|                      |   |
|----------------------|---|
| Frequency            |   |
| Range:               | 8 GHz model: 300 kHz to 8 GHz<br>20 GHz model: 300 kHz to 20 GHz  |
| Set-up resolution:   | 1 Hz  |
| Output power         |   |
| Range                |   |
| 8 GHz 2-port model:  | -9 dBm to +11 dBm (300 kHz to 0.5 GHz)<br>-7 dBm to +13 dBm (0.5 GHz to 4.0 GHz)<br>-10 dBm to +10 dBm (4.0 GHz to 6.0 GHz)<br>-12 dBm to +8 dBm (6.0 GHz to 8.0 GHz)   |
| 20 GHz 2-port model: | -10 dBm to +10 dBm (300 kHz to 4.0 GHz)<br>-13 dBm to +7 dBm (4.0 GHz to 6.0 GHz)<br>-15 dBm to +5 dBm (6.0 GHz to 8.0 GHz)<br>-19 dBm to +1 dBm (8.0 GHz to 11 GHz)<br>-20 dBm to 0 dBm (11 GHz to 15 GHz)<br>-22 dBm to -2 dBm (15 GHz to 20 GHz) |
| Sweep functions      |   |
| Sweep type:          | Linear, Log, Program, Power   |
| Sweep time:          | 5 $\mu$ s/point (RBW 400 kHz)   |
| Number of points:    | 3 to 1601 points  |
| Sweep trigger:       | Continuation, single, hold, external  |

### System characteristics

|                       |  |
|-----------------------|--|
| System dynamic range: | At the time of isolation calibration execution, Averages: 8 times, RBW 10 Hz (Typ.)  |
| 8 GHz model:          | -123 dB (300 kHz to 700 MHz)<br>-125 dB (700 MHz to 3.8 GHz)<br>-124 dB (3.8 GHz to 6.0 GHz)<br>-123 dB (6.0 GHz to 8.0 GHz) |
| 20 GHz 2-port model:  | -123 dB (300 kHz to 700 MHz)<br>-125 dB (700 MHz to 8.0 GHz)<br>-117 dB (8.0 GHz to 20 GHz)                                  |

### Receiving part characteristics

|                                |  |
|--------------------------------|--|
| Resolution bandwidth:          | 400 kHz, 200 kHz, 150 kHz, 100 kHz<br>100 kHz to 10 Hz (1, 1.5, 2, 3, 4, 5, 7 steps)   |
| Amplitude characteristics      |  |
| Amplitude resolution:          | 0.001 dB   |
| Dynamic accuracy:              | Maximum input to basic -20 dB input<br>$\pm 0.20$ dB (0 to -10 dB, 300 kHz to 4 GHz)<br>$\pm 0.30$ dB (0 to -10 dB, 4 GHz to 8 GHz)<br>$\pm 0.40$ dB (0 to -10 dB, 8 GHz to 20 GHz)<br>$\pm 0.05$ dB (-10 to -50 dB)<br>$\pm 0.10$ dB (-50 to -60 dB)<br>$\pm 0.40$ dB (-60 to -70 dB)<br>$\pm 1.00$ dB (-70 to -90 dB)  |
| Phase characteristics          |  |
| Phase resolution:              | 0.01°  |
| Dynamic accuracy:              | Maximum input to basic -20 dB input<br>$\pm 2.0^\circ$ (0 to -10 dB, 300 kHz to 4 GHz)<br>$\pm 3.0^\circ$ (0 to -10 dB, 4 GHz to 8 GHz)<br>$\pm 4.0^\circ$ (0 to -10 dB, 8 GHz to 20 GHz)<br>$\pm 0.3^\circ$ (-10 to -50 dB)<br>$\pm 0.4^\circ$ (-50 to -60 dB)<br>$\pm 1.5^\circ$ (-60 to -70 dB)<br>$\pm 4.0^\circ$ (-70 to -80 dB)<br>$\pm 8.0^\circ$ (-80 to -90 dB) |
| Group delay characteristic:    | The group delay is calculated using the following formula:<br>$\frac{\Delta\Phi}{360 \times \Delta f}$ $\Delta\Phi$ : Phase difference<br>$\Delta f$ : Frequency difference (Aperture frequency)   |
| Group delay time resolution:   | 1 pS   |
| Aperture frequency:            | [100/(measurement point - 1)] x [2% to 50%]<br>of setting frequency range can be set   |
| Accuracy:                      | Phase accuracy<br>$\frac{360 \times \text{Aperture frequency (Hz)}}{\text{Phase accuracy}}$  |
| Test port characteristics      |  |
| Input destructive level:       | +21 dBm, 16 Vdc  |
| Test port Connector:           | 8 GHz model: N-connector (female)<br>20 GHz model: 3.5 mm connector (male)   |
| Other functions                |  |
| Display part                   |  |
| Display:                       | 12.1 inches SVGA TFT color liquid crystal display  |
| Back light:                    | Luminosity half-life 40000H (Typ.)   |
| Error compensation:            | Normalize, 1-port cal, 2-port cal, 3-port cal<br>Averaging and smoothing<br>Electric length compensation, phase offset compensation  |
| Marker functions:              | Multi-marker 16 pieces<br>$\Delta$ marker, Search function, Marker $\rightarrow$ Function  |
| Limit line functions:          | Set-up is possible a maximum of 32 segments.<br>PASS/FAIL display function   |
| Save load function:            | Floppy disk or HDD   |
| Program execution environment: | Execution form by Visual Basic etc. can be operated.   |
| FDD function:                  | MS-DOS FAT format<br>2 modes correspondence<br>(DD 720 KB, HD 1.4 MB)  |

## Connection with external apparatus

|                                    |   |
|------------------------------------|---|
| External display signal:           | 15-pin D-SUB connector (SVGA)   |
| GPIB:                              | IEEE488.1, IEEE488.2 conformity   |
| Parallel Port:                     | TTL level<br>Output port (8 bit x 2-port)<br>In/Out port (4 bit x 2-port) |
| Serial port:                       | Accessories serial I/O  |
| Printer Port:                      | IEEE-1284-1994 conformity   |
| LAN Port:                          | 10 Base-T   |
| Keyboard:                          | PS/2 101/106 keyboard   |
| Mouse:                             | PS/2 mouse  |
| External standard frequency input: | 1 MHz, 2 MHz, 5 MHz, 10 MHz ( $\pm 10$ ppm)<br>0 dBm (50 $\Omega$ )       |
| Probe power:                       | $\pm 15$ V $\pm 0.5$ V, 300 mA  |

## General specifications

|                        |  |
|------------------------|--|
| Operating temperature: | Temperature range: +5 to +40°C<br>Relative humidity 80% or less<br>(No condensation)                                   |
| Storage temperature:   | -20 to +60°C   |
| Power supply:          | 100 to 120 VAC, 50/60 Hz<br>220 to 240 VAC, 50/60 Hz<br>(100 VAC system and 200 VAC system are switched automatically) |
| Dimensions             |  |
| R3860A:                | Approx. 424 (W) x 266 (H) x 530 (D) mm   |
| R3768/3770:            | Approx. 424 (W) x 266 (H) x 450 (D) mm   |
| Mass                   |  |
| R3860A:                | 32 kg or less  |
| R3768/3770:            | 28 kg or less  |
| Power consumption:     | 500 VA or less   |
| Accessories:           | Operation manual, power supply cable   |

For details of the R3680A/3768/3770 performance specifications, see the attached "R3680A/3768/3770 Data Sheet"

*Please be sure to read the product manual thoroughly before using the products.  
Specifications may change without notification.*