

# Agilent 16900 Series Logic Analysis System Mainframes

Data Sheet

## Conquer your toughest digital debug problems while staying within your budget

The Agilent 16900 Series modular logic analysis mainframes deliver the performance you need to conquer your toughest digital debug problems. You get accurate and reliable measurements for today's complex circuits, with expandability and performance headroom to cover future technology trends. In addition, the intuitive user interface gives you the ultimate in productivity without sacrificing performance or capability. You get performance and intuitive usability at a price you can afford.

## Expand your system as your needs evolve

Expandability is the key to the long-term value of the Agilent 16900 Series logic analysis systems. Purchase the capability you need now, then expand as your needs evolve. Maximize mainframe usage by operating them separately, then connecting them together for complex, high-channel-count, multiple-bus applications. Whether you are doing simple hardware debug, real-time analysis of instruction execution, hardware/software integration, signal-quality analysis or complex system validation, you have a system that meets each of your long-term digital measurement needs.

## Spend more time designing and less time learning how to use your tools

If you want to focus on solving your digital debug problems, you need to be able to quickly master your debug tools. The 16900 Series logic analysis mainframes let you set up measurements easily and navigate through your data quickly with an intuitive user interface and familiarity of Windows® XP Professional.



Figure 1. The Agilent 16900A, 16902A and 16903A modular logic analysis systems.



Agilent Technologies

**The flexibility you need to debug your design your way**

Increase your productivity with a variety of operating modes that maximize your analyzer's usage. Whether you work alone at a bench or with team members distributed around the world, the 16900 Series provides a use model that easily integrates into your debug environment.

**Work at your bench** – Operate the analyzer via touch screen, mouse or keyboard.

**Expand view across multiple monitors** – Get the most comprehensive view of your data with extended desktop viewing.

**Remotely control and monitor the logic analyzer** – Access a remote logic analyzer via built-in Windows XP desktop sharing. Receive e-mail when the logic analyzer triggers.

**Work offline** – Increase equipment and team productivity. View and analyze captured data on a PC while the logic analyzer makes other measurements. Also, create setups for your next round of measurements.

**Run automated tests** – Execute a series of tests via the ASCII remote programming interface or Microsoft DCOM.

**Offload data for custom analysis** – Move data quickly over the optional Gbit LAN connection to an external PC.

**Combine mainframes to expand measurement capability** – Use mainframes individually, then connect them together when you need to analyze complex, multiple-bus problems.

**Maximize system performance** – Augment the logic analyzer's high performance with the latest PC or server technology to control the logic analyzer and analyze data.

**Share information with others** – Save your results to shared drives.

**Document your findings** – Print screen shots to networked printers and cut and paste data into other software applications.

**Comply with your company's network standards** – Add anti-virus software to the open Windows XP Pro-based logic analyzer.



**Figure 2. Get the most comprehensive view of your data with extended desktop viewing.**

**16900 Series mainframe — the power you need at a price you can afford**

The mainframe you select is the foundation of your system. The Agilent 16900 Series includes a range of powerful logic analysis mainframes that deliver the performance you need at a price you can afford. You get accurate and reliable measurements, for today’s complex systems, plus expandability and performance headroom to cover future technology trends.

**Key things to consider when selecting a 16900 Series mainframe:**

- **Number of module slots** — Determine the number of measurement modules required for your specific measurement need. Also consider having additional slots for future needs.
- **Multiframe Pro** — 16900 Series mainframes can always be used as a standalone unit. In some instances your channel needs may surpass a single mainframe. For situations where you need to debug large, multiple-bus systems, ensure that the mainframe you choose supports Multiframe Pro. Multiframe Pro allows you to connect multiple frames into one measurement system with a single interface control.
- **Display and resolution** — If you prefer to operate the analyzer directly from the front panel, select a mainframe with a large, built-in touch display. All 16900 Series mainframes can also be used with external monitors.
- **PCI expansion slots** — Customize your logic analyzer peripherals by adding PCI cards for a specific capability like Gbit LAN or multiple monitor video.

**Select the 16900 Series mainframe that meets your requirements**

Agilent model number	16902A	16900A	16903A
Number of module slots	6	6	3
Multiframe Pro	Yes	Yes	No
Display and resolution	Built-in color touch screen display, 12.1 inch at 800 x 600, supports up to four external monitors at up to 1600 x 1200 (with PCI video card)	Uses external display. Supports up to four external displays at up to 1600 x 1200 (with PCI video card)	Built-in color touch screen display, 12.1 inch at 800 x 600, supports up to four external monitors at up to 1600 x 1200 (with PCI video card)
PCI expansion slots	1 full profile, 1 low profile	1 full profile, 1 low profile	1 full profile, 1 low profile

**Table 1. Agilent modular 16900 Series mainframes.**

**Agilent 16900 Series Features**

Modularity and Expandability	Protect your long-term investment. Start with the capability you need now, then add measurement modules or expand the number of frames in the system as your needs evolve.
Intuitive user interface	Quickly master the logic analyzer due to the award winning usability and familiarity of Windows XP Pro.
Hosted Power Mode and Offline Analysis	Achieve the ultimate in performance by hosting the logic analyzer application software on your fastest server to remotely control the logic analyzer and analyze data.
Open PC platform	Accelerate your debugging process with an extensive range of optional software analysis tools. Protect your data and make your logic analyzer compliant with your network environment with anti-virus software. Share your work and communicate results easily via LAN or USB flash drives
Full programmability	Modify any measurement setting using COM via LAN.
Wide range of use models	Increase your productivity and maximize your analyzer’s usage by local or widely-distributed teams. (See page 2)

**Table 2. Key features and benefits of Agilent 16900 Series logic analysis systems.**

**Modular expandability protects your long-term investment**

Configure a custom logic analysis system with analyzer modules to fit your performance and price needs. Protect your investment by upgrading memory depths or state speeds as your needs change.

**Measurement Module Support**

The 16900 Series supports the following measurement modules:

**Timing/State Modules**

- 16950A
- 16910A, 16911A
- 16760A
- 16753A, 16754A, 16755A, 16756A
- 16750A/B, 16751A/B, 16752A/B
- 16740A, 16741A, 16742A

**Pattern Generator Module**

- 16720A

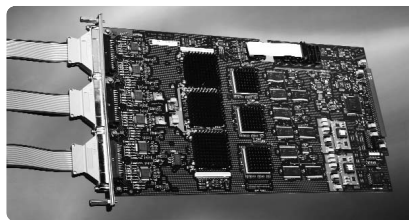

**Figure 3. Combine multiple acquisition modules when you need to measure across many channels.**



**Figure 4. Modularity provides configuration flexibility to meet your measurement needs—now and in the future.**

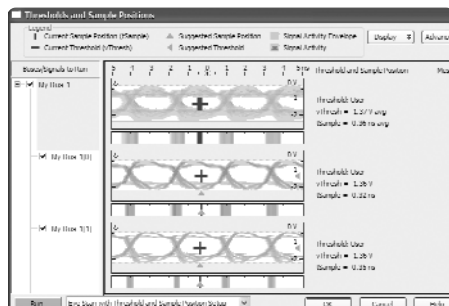

**Figure 5. Identify problem signals quickly by viewing eye diagrams across all buses and signals simultaneously.**

	Half channels	Full channels
Max clock speed	300 MHz	180 MHz
Max memory depth	16 M Vectors	8 M Vectors
Channels per module	24	48
Max number of channels per time base	120	240
Stimulus commands	Initialize, Block, Repeat, and Break Macros	
Logic levels supported	5 V TTL, 3 state TTL, 3 state CMOS, 3 state 3.3 V ECL, 5 V PECL, 3.3 V LVPECL, 3 state 2.5 V, 3 state 1.8 V, LVDS	

1 Order at least one clock pod for each module used as a master and at least one data pod for every 8 output channels.

**Table 3. Add a pattern generator module to drive down risk early in product development.**

## Choose the modules that meet your specific needs

Agilent model number	16910A <sup>2,3</sup> /16911A <sup>2,3</sup>	16950A <sup>2,3</sup>	16760A <sup>2</sup>
Channels per module	102 / 68	68	34
Max channels on a single timebase and trigger	510/340	340	170
Memory depths	256 K: Opt 256 1 M: Opt 001 4 M: Opt 004 16 M: Opt 016 32 M: Opt 032	256 K: Opt 256 1 M: Opt 001 4 M: Opt 004 16 M: Opt 016 32 M: Opt 032 64 M: Opt 064	64 M
High speed timing rate <sup>1</sup>	4 GHz (250 ps) with 64 K depth	4 GHz (250 ps) with 64 K depth	
Max deep memory timing sample rate (full/half channel)	1.0 GHz (1.0 ns)/ 500 MHz (2.0 ns)	1.2 GHz (833 ps)/ 600 MHz (1.67 ns)	800 MHz
Transitional timing	500 MHz (2.0 ns)	600 MHz (1.67 ns)	400 MHz (2.5 ns)
Max state clock rate	250 MHz (Opt 250) 450 MHz (Opt 500)	600 MHz	800 MHz
Max state data rate	250 Mb/s (Opt 250) 500 Mb/s (Opt 500)	800 Mb/s	1.5 Gb/s
Voltage threshold ranges	-5 V to 5 V (10 mV increments)	-3 V to 5 V (10 mV increments)	-3 V to 5 V (10 mV increments)
Eye finder and eye scan support	Yes	Yes	Yes
Supported signal types	Single-ended	Single-ended and differential	Single-ended and differential
Probe compatibility	40-pin cable connector	90-pin cable connector	90-pin cable connector

<sup>1</sup> All channels, all the time, simultaneous state and timing through same probe.

<sup>2</sup> Probes are ordered separately. Please specify probes when ordering to ensure the correct connection between your logic analyzer and the device under test.

<sup>3</sup> Specify desired memory depth, state clock and data rate using available options. Feature also available via software upgrade to existing module.

**Table 4. Select the logic analyzer modules that best suit your requirements.**

### Headroom for your future needs (Extend the life of your equipment)

Easily upgrade your 16900 Series modules. “Turn on” additional memory depth and state speed when you need more. Purchase the capability you need now, then upgrade as your needs evolve.

16910A 16911A	Upgrade max. state speed from 250 MHz to 450 MHz and max. data rate from 250 Mb/s to 500 Mb/s
	Memory depth options 256 K, 1 M, 4 M, 16 M or 32 M
16950A	Memory depth options 256 K, 1 M, 4 M, 16 M, 32 M or 64 M

## Unleash the complementary power of a logic analyzer and an oscilloscope

Easily make time-correlated measurements between Agilent logic analyzers and oscilloscopes. The time-correlated logic analyzer and oscilloscope waveforms are integrated into a single logic analyzer waveform display for easy viewing and analysis. You can also trigger the oscilloscope from the logic analyzer (or vice versa), automatically de-skew the tracking between the two instruments.

Perform the following more effectively:

- Validate signal integrity
- Track down problems caused by signal integrity
- Validate correct operation of A/D and D/A converters
- Validate correct logical and timing relationships between the analog and digital portions of a design

### Logic analyzer and oscilloscope connection

Number of oscilloscopes connected to a logic analyzer 1

Logic analyzer connections	LAN, trigger in, trigger out
Oscilloscope connections	LAN, trigger in, trigger out

**Table 6. Agilent logic analyzer and oscilloscope compatibility and connections.**

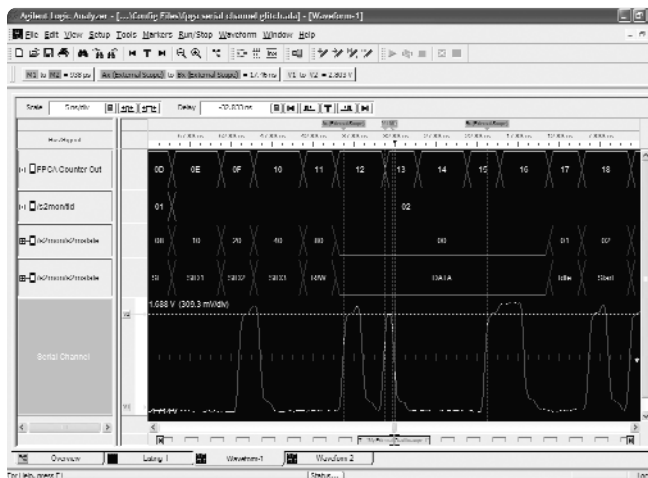

**Figure 5. Make time-correlated measurements between an Agilent logic analyzer and oscilloscope with the Agilent E5850 time-correlation fixture.**

Feature	Benefit
Automated setup	Quickly get to your first measurement using the logic analyzer's help wizard for easy setup, regardless of which supported Agilent oscilloscope you connect to.
Integrated waveform display	Instantly validate the logical and timing relationships between the analog and digital portions of your design. View oscilloscope and logic analyzer waveforms integrated into a single logic analyzer waveform display.
Automatic measurement de-skew	Save time and gain confidence in measurement results with measurements that are automatically de-skewed in time.
Cross trigger the logic analyzer and oscilloscope	Start your debug approach from either the analog or digital domain with the flexibility to trigger the oscilloscope from the logic analyzer (or vice versa).
Tracking markers	Precisely relate information on the oscilloscope's display to the corresponding point in time on the logic analyzer display with tracking markers. The oscilloscope's time markers automatically track adjustments of the logic analyzer's global markers.

**Table 5. Key features and benefits of integrating Agilent oscilloscope and logic analyzer capabilities.**

### Compatibility

Agilent logic analyzers	16900 Series modular logic analysis systems (ver 03.20 or higher) 1680 Series standalone logic analyzers (ver 03.20 or higher) 1690 Series PC-Hosted logic analyzers (ver 03.20 or higher)
Agilent oscilloscopes	DSO80000 Series (ver 3.90 or higher) Infiniium 54800 Series (ver 3.90 or higher) 6000 Series (ver 3.90 or higher)

## Optional analysis and automated measurement packages

B4655A FPGA dynamic probe	Gain unprecedented visibility into your FPGA's internal activity. Make incremental real time measurements in seconds without stopping the FPGA, changing the design or modifying design timing. Quickly set up the logic analyzer with automatic pin mapping and signal bus naming by leveraging work you did in your design environment. <a href="http://www.agilent.com/find/fpga">www.agilent.com/find/fpga</a>
B4601C serial-to-parallel analysis package	Eliminate the very tedious, time-consuming, and error-prone task of sifting through thousands of serial bits by looking at long vertical columns of captured 1's and 0's. The B4601C serial-to-parallel analysis package is general-purpose software that allows easy viewing and analysis of serial data.
B4606A advanced customization environment - development and runtime package	Tailor the logic analyzer interface with a wide range of control, analysis and display capabilities specific to your measurement application. Create integrated dialogs, graphical displays and analysis functions to quickly manipulate measurement data into a format that provides additional insight and answers. <a href="http://www.agilent.com/find/logic-customview">www.agilent.com/find/logic-customview</a>
B4607A advanced customization environment - runtime package	Run the macros and graphical views created with a B4606A development package or obtain and run a variety of commonly requested tools from Agilent and it's partners to help customize your measurement environment.
B4608A ASCII remote programming interface	Remotely control a 16900-, 1680-, or 1690-Series logic analysis system by issuing ASCII commands. This interface is designed to be as similar as possible to the RPI on the 16700-Series logic analysis system, so that you can reuse existing programs. Requires that either the B4606A or B4607A is enabled. You can also use the B4606A to customize and add RPI commands.

## Processor, bus and FPGA support

Agilent Technologies and our partners provide an extensive range of bus and processor analysis probes. They provide non-intrusive, full-speed, real-time analysis to accelerate your debugging process.

- Save time making bus- and processor-specific measurements with application specific analysis probes that quickly and reliably connect to your device under test.
- Display processor mnemonics or bus cycle decode.
- Get support for a comprehensive list of industry-standard processors and buses.

Microprocessors/ microcontrollers	FPGAs	I/O buses	Memory buses	Serial buses	Graphics buses
AMD, Analog Devices, ARM, AT&T, Dallas, DEC, Freescale, GTE, IBM, IDT, Infineon, Intel, LSI Logic, McDonnell Douglas, MIPS Motorola, National, NEC, PACE, PMC Sierra/QED, Rockwell, Siemens, Texas Instruments, Toshiba, Zilog	Xilinx Virtex 4, Virtex-II Pro series, Virtex-II series, Spartan-3 series	PCI, PCI-X, PCI-Express, Serial ATA (SATA 1 and 2), SCSI, Serial Attached SCSI (SAS), HyperTransport	DDR1, DDR2, PC-100/133, GDDR3, Fully Buffered DIMM (FB-DIMM), Rambus	Fibre Channel, I <sup>2</sup> C, IEEE-1394, Serial ATA (SATA 1 and 2), USB 2.0/1.1, PCI-Express, RS-232, CAN, IEEE-488	AGP2x, AGP4x, AGP3.0, PCI-Express

## 16900 Series mainframes characteristics

### Standard data views

Waveform	Integrated display of data as digital waveforms, analog waveforms imported from an external oscilloscope, and/or as a chart of a bus' values over time.
Listing	Displays data as a state listing.
Compare	Compares data from different acquisitions and highlights differences.
Source code	<p>Displays time-correlated source code and inverse assembly simultaneously in a split display.</p> <p>Define the trigger event by simply clicking on a line of source code.</p> <p>Obtain source-code-level views of dynamically loaded software or code moved from ROM to RAM during a boot-up sequence using address offsets.</p> <p>Requires access to source files via the LAN or instrument hard drive to provide source code correlation.</p> <p>Source correlation does not require any modification or recompilation of your source code.</p>
Eye Scan	Displays eye diagrams across all buses and signals simultaneously, allowing you to identify problem signals quickly.

### Numeric bases for data display

Binary, hex, octal, decimal, signed decimal (two's complement), ASCII, symbols, and processor mnemonics

### Symbolic support/object file format compatibility

Number of symbols/ranges — Unlimited (limited only by amount of virtual memory available on 16900 Series mainframes)

IEEE-695, Aout, Omf86, Omf96, Omf386, Sysrof, ELF/DWARF1,\* ELF/DWARF2\*, ELF/Stabs1, ELF/Stabs2, ELF/Mdebug Stabs, TICOFF/COFF, TICOFF/Stabs

GPA (General Purpose ASCII)

User defined — specify a mnemonic for a given bit pattern for a label or bus

\* Supports C++ name de-mangling

### Available data/file formats

ala	Contains information to reconstruct the display appearance, instrument settings, and trace data (optional) that were present when the file was created.
xml	Extensible markup language for configuration portability and programmability.
csv	CSV (comma-separated values) format for transferring data to other applications like Excel.
mfb	Export logic analyzer data for post-processing. Mfb data can be parsed using programming tools.

### Standard analysis tools

Filter/colorize

Find (next/previous)



## 16900 Series PC characteristics

Operating system	Microsoft Windows XP Professional
Processor	Intel Pentium® III
Chipset	Intel 815E
System memory	512 MB PC 133 SDRAM max
CD ROM	24x CD-R writing, 24x CD-RW writing, 8x CD ROM reading
Hard disk drive	80 GB
Installed on hard drive	Operating system, latest revision of the logic analyzer application software, optional application software ordered with the mainframe

## 16900 Series instrument controls

Touch-screen LCD display (16902A and 16903A)	Large 30.7-cm (12.1-in.) display makes is easy to view a large number of waveforms or states.
Front-panel hot keys (16902A and 16903A)	Dedicated hot keys give instant access to the most frequently used menus, displays, and on-line help.
Front-panel knobs (16902A and 16903A)	Dedicated knobs for horizontal and vertical scaling and scrolling
Keyboard and mouse	PS/2 keyboard and mouse (shipped standard)

## 16900 Series video display modes

### Built-in touch-screen display (16902A and 16903A)

Size	30.7 cm (12.1 in.) diagonal
Resolution	800 x 600
Simultaneous display capability	Front panel and external display can be used simultaneously at 800 x 600 resolution.
<b>External display</b>	Supports up to four external monitors at up to 1600x1200 (with PCI video card)

## Programmability

You can write programs to control the logic analyzer application from remote computers on the local area network using COM or ASCII.

The COM automation server is part of the logic analyzer application. This software allows you to write programs to control the logic analyzer. All measurement functionality is controllable via the COM interface.

The B4606A Remote Programming Interface (RPI) lets you remotely control a 16900-Series logic analysis system by issuing ASCII commands to the TCP socket on port 6500. This

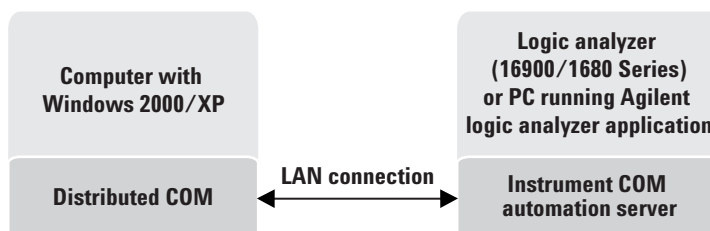

**Figure 7. 16900 Series programming overview**

interface is designed to be as similar as possible to the RPI on 16700-Series logic analysis systems, so that you can reuse existing programs.

The Remote Programming Interface works through the COM automation objects, methods, and properties provided for control-

ling the logic analyzer application. RPI commands are implemented as Visual Basic modules that execute COM automation commands, translate their results, and return proper values for the RPI. You can use the B4606A Advanced Customization Environment to customize and add RPI commands.

## 16900 Series interfaces

### Peripheral interfaces

Display	15-pin VGA connector
Keyboard	PS/2
Mouse	PS/2
Parallel	25-pin D-sub
Serial	9-pin D-sub
PCI card expansion slots	1 full profile and 1 low profile
USB	Two 1.1 ports

### Connectivity interfaces

LAN	10/100Mb/s, Gbit (optional)
Connector	RJ-45

### Interface with external instrumentation

Trigger or arm external devices or receive signals that can be used to arm measurement modules within the logic analyzer with Trigger In/Out.

#### Trigger In

Input	Rising edge or falling edge
Action taken	When received, the logic analyzer takes the actions described in the trigger sequence step.
Input signal level	$\pm 5$ V max
Threshold level	Selectable: ECL, LVPECL, LVTTTL, PECL, TTL User defined ( $\pm 5$ V in 50 mV increments)
Minimum signal amplitude	200 mV
Connector	BNC
Input resistance	4 k ohm nominal

#### Trigger Out

Trigger	Rising edge or falling edge. OR of selected events that cause Trigger Out (module trigger or flags)
Output signal	$V_{OH}$ (output high level) 2.0 V min $V_{OL}$ (output low level) 0.5 V max Pulse width approx. 80-160 ns
Threshold level	LVTTTL (3.3 V logic)
Signal load	50 ohm (For good signal quality, the trigger out signal should be terminated in 50 ohms to ground)
Connector	BNC

### Remote control or your device under test

Conveniently control your target remotely by using the target control port to activate reset or interrupt lines.

#### Target control port

Number of signals	8
Output Disabled	Tri-state, high-impedance
Output Enabled	TTL level with 1 high, 0 low
Toggle	Flips the setting of the signal. If the signal is set to 1, Toggle changes the signal to 0.
Pulse	Flips the signal setting for one clock cycle which is at least 16 ms. The pulse duration cannot be specified.
Levels	3.3 V (LVTTTL) compatible
Connector	2 rows of 5 pins, 0.1-inch centers

## 16900 Series physical characteristics

### Dimensions

#### Power

16900A	115/230 V, 48 to 66 Hz, 1300 W max
16902A	115/230 V, 48 to 66 Hz, 1300 W max
16903A	115/230 V, 48 to 66 Hz, 900 W max

#### Weight\*

	Max Net	Max Shipping
16900A	16 kg (35.2 lbs)	24.6 kg (54.2 lbs)
16902A	17.2 kg (37.8 lbs)	25.8 kg (56.8 lbs)
16903A	14.5 kg (32.0 lbs)	23.2 kg (51.0 lbs)

\* Weight of modules ordered with mainframes will add 0.9 kg (2.0 lb per module)

### Instrument operating environment

Temperature	<ul style="list-style-type: none"> <li>• 0° C to 50° C (32° F to 122° F) for 16903A</li> <li>• 0° C to 40° C (32° F to 104° F) for 16900A and 16902A</li> </ul>
Altitude	To 3000m (10,000 ft)
Humidity	8 to 80% relative humidity at 40° C (104° F)

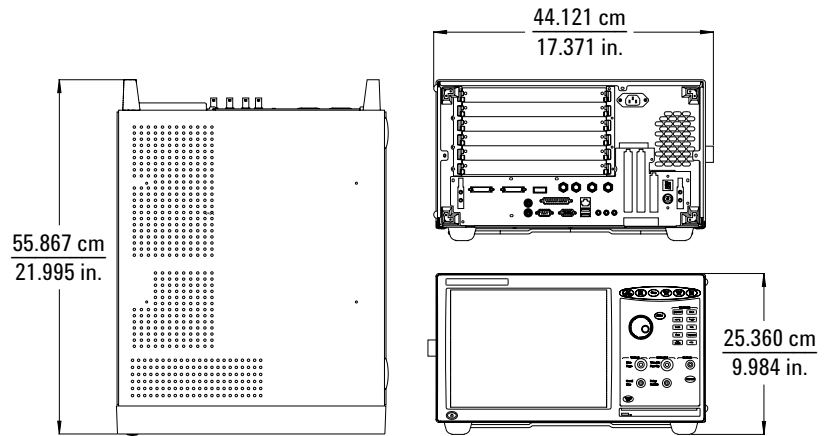

Figure 8. 16900A/16902A/16903A exterior dimensions

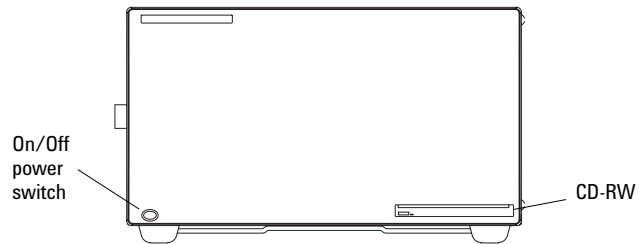

Figure 9. Agilent 16900A front panel

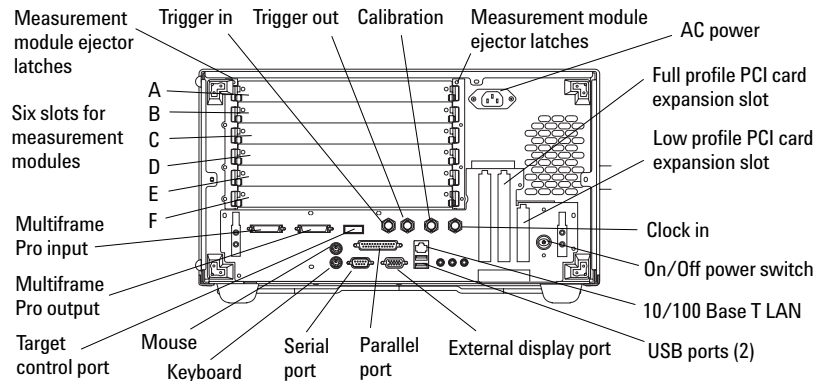
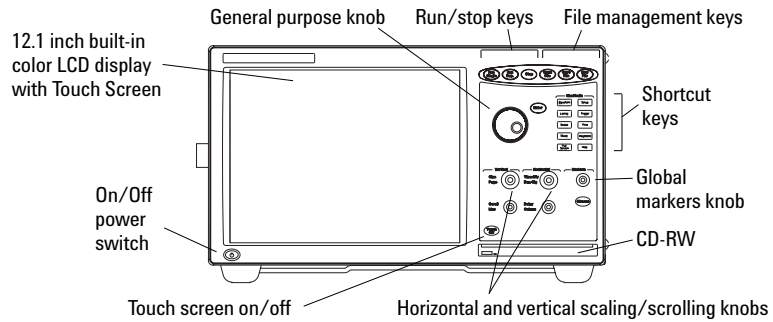

Figure 10. Agilent 16900A back panel

**16900 Series physical characteristics**

**Dimensions, continued**



**Figure 11. Agilent 16902A front panel**

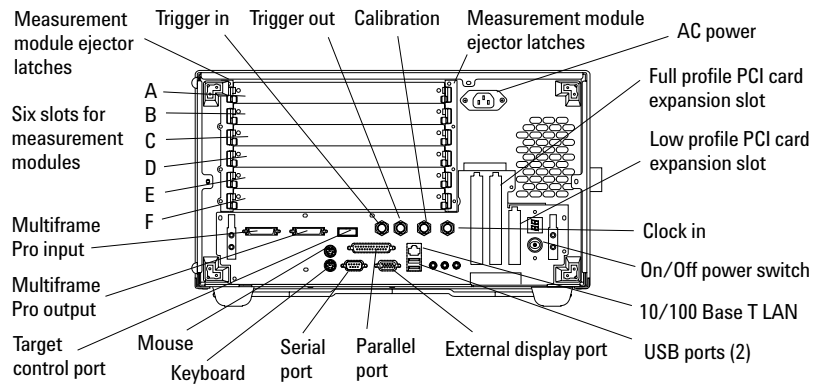

**Figure 12. Agilent 16902A back panel**

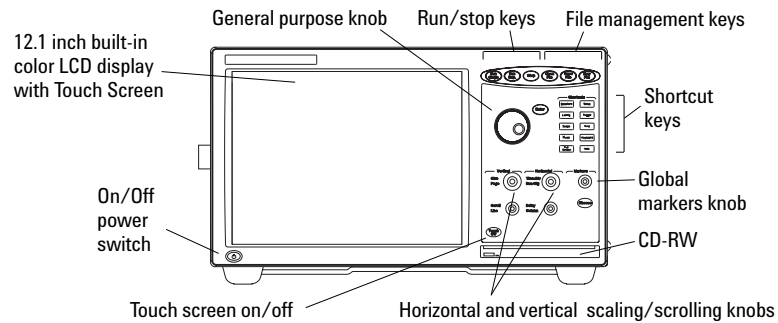

**Figure 13. Agilent 16903A front panel**

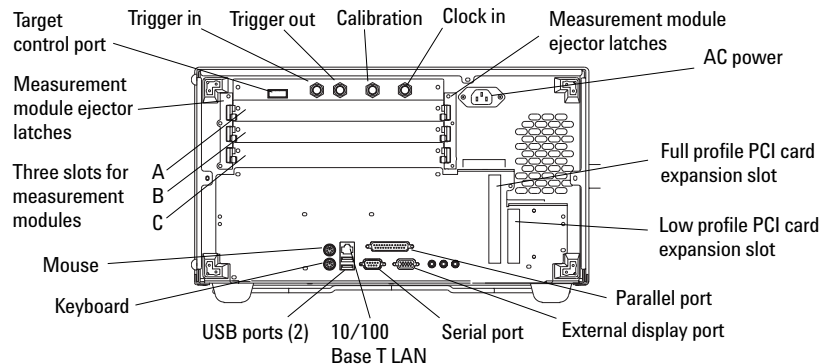

**Figure 14. Agilent 16903A back panel**

## Agilent 1184A Testmobile

The Agilent 1184A testmobile gives you a convenient means of organizing and transporting your logic analysis system mainframes and accessories.

The testmobile includes the following:

- Drawer for accessories (probes, cables, power cords)
- Keyboard tray with adjustable tilt and height
- Mouse extension on keyboard tray for either right or left hand operation
- Locking casters for stability on uneven surfaces
- Strap to stabilize the monitor
- Load limits: Top tray: 68.2 kg (150.0 lb.) Lower tray: 68.2 kg (150.0 lb.) Total: 136.4 kg (300.0 lb.)



Figure 15. Agilent 1184A testmobile cart.

### Weight

	Max Net	Max Shipping
1184A	48.0 kg (106.0 lb)	59.0 kg (130.0 lbs)

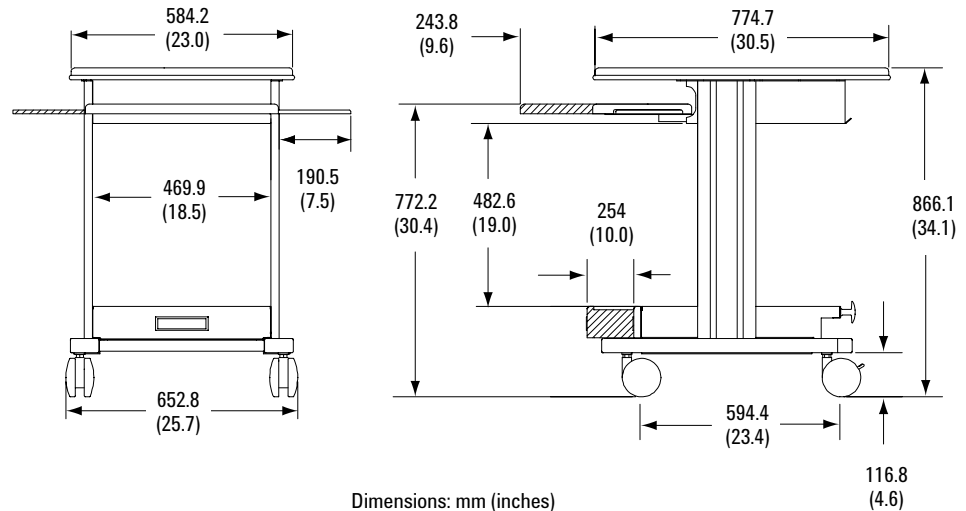
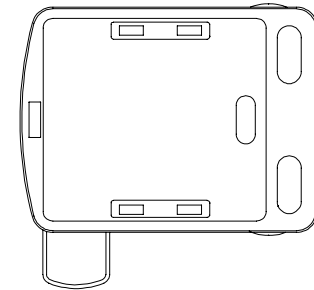

Figure 16. Agilent 1184A testmobile cart dimensions.

## Rack Accessories

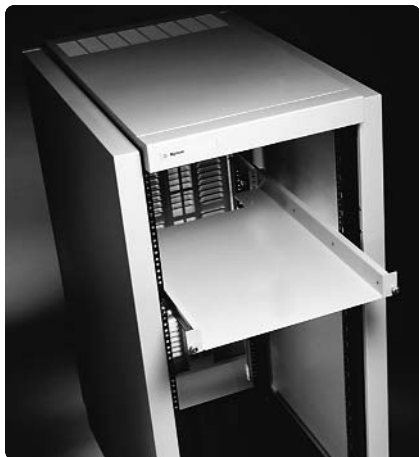

Figure 17. Sliding shelf installed in rack

### Stationary Shelf

This light-duty fixed shelf is designed to support the 16900 series frames. The shelf can be used in all standard Agilent racks. The stationary shelf is mounted securely into place using the supplied hardware and is designed to sit at the bottom of the EIA increment. Features of the stationary shelf include:

- Snap-in design for easy installation
- Smooth edges

### Sliding Shelf

The sliding shelf provides a flat surface with full product accessibility. It can be used in all Agilent racks to support the 16900 series logic analysis systems. The shelf and slides are preassembled for easy installation. Features of the sliding shelf include:

- Snap-in design for easy installation
- Smooth edges

Consider purchasing the steel ballast (C2790AC) to use with the sliding shelf. The ballast provides anti-tip capability when the shelf is extended.



Figure 18. Stationary shelf (J1520AC)

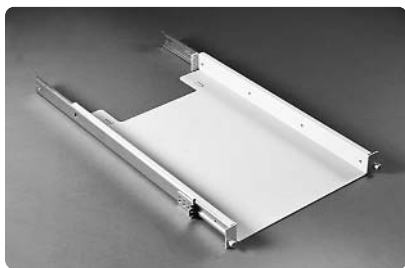

Figure 19. Sliding shelf (J1526AC)

## Specifications

	J1520AC	J1526AC
Material	Cold-rolled steel	Cold-rolled steel
Weight	8 kg (17.6 lbs)	9.9 kg (22 lbs)
Color	Quartz gray	Quartz gray
Length	678 mm (26.7 in)	723.9 mm (28.5 in)
Height	44 mm (1.73 in)	44.5 mm (1.75 in)
Width	444 mm (17.5 in)	482.6 mm (19 in)
Load Capacity	68 kg (150 lbs)	Capacity 68 kg (150 lbs)
Contains	1 stationary shelf 2 rear brackets Mounting hardware	1 sliding shelf 2 rear brackets 1 cable strap Mounting hardware

## Ordering Information

### Agilent product number

### Description

16900A	6-Slot Logic Analysis System Mainframe
16902A	6-Slot Logic Analysis System Mainframe with Built-in Touch Display
16903A	3-Slot Logic Analysis System Mainframe with Built-in Touch Display

Each frame comes with one PS/2 keyboard, one PS/2 mouse, one ten-conductor flying lead cable for target control port, accessory pouch, and 1-year warranty standard.

### Agilent product number or option number

### Description

### Ordering info

16900A-014 16902A-014 16903A-014	Gbit LAN card for 16900 Series mainframes (low profile, copper connection).	Installed in mainframe. Must be ordered at time of mainframe purchase
E5860A	Gbit LAN card for 16900 Series mainframes (low profile, copper connection).	Order for existing frames. Customer installable.
E5861A	Multiframe cable cable length	Order 1 less than the number of mainframes to be connected together

## Related Agilent literature

### Publication

### Description

### Agilent pub. number

<i>Agilent Technologies 16900 Series Logic Analysis Systems</i>	Color Brochure	5989-0420EN
---	----------------	-------------

<i>Agilent Technologies Timing and State Modules for the 16900 Series</i>	Data Sheet	5989-0422EN
---	------------	-------------

<i>Agilent Technologies FPGA Dynamic Probe</i>	Data Sheet	5989-0423EN
--	------------	-------------

<i>Probing Solutions for Agilent Technologies Logic Analyzers</i>	Catalog	5968-4632E
---	---------	------------

<i>Processor and Bus Support for Agilent Technologies Logic Analyzers</i>	Configuration Guide	5966-4365E
---	---------------------	------------

For copies of this literature, contact your Agilent representative or visit [www.agilent.com/find/16900](http://www.agilent.com/find/16900)

### Agilent Technologies' Test and Measurement Support, Services, and Assistance

Agilent Technologies aims to maximize the value you receive, while minimizing your risk and problems. We strive to ensure that you get the test and measurement capabilities you paid for and obtain the support you need. Our extensive support resources and services can help you choose the right Agilent products for your applications and apply them successfully. Every instrument and system we sell has a global warranty. Two concepts underlie Agilent's overall support policy: "Our Promise" and "Your Advantage."

#### Our Promise

Our Promise means your Agilent test and measurement equipment will meet its advertised performance and functionality. When you are choosing new equipment, we will help you with product information, including realistic performance specifications and practical recommendations from experienced test engineers. When you receive your new Agilent equipment, we can help verify that it works properly and help with initial product operation.

#### Your Advantage

Your Advantage means that Agilent offers a wide range of additional expert test and measurement services, which you can purchase according to your unique technical and business needs. Solve problems efficiently and gain a competitive edge by contracting with us for calibration, extra-cost upgrades, out-of-warranty repairs, and on-site education and training, as well as design, system integration, project management, and other professional engineering services. Experienced Agilent engineers and technicians worldwide can help you maximize your productivity, optimize the return on investment of your Agilent instruments and systems, and obtain dependable measurement accuracy for the life of those products.



### Agilent Email Updates

[www.agilent.com/find/emailupdates](http://www.agilent.com/find/emailupdates)

Get the latest information on the products and applications you select.



### Agilent Direct

[www.agilent.com/find/agilentdirect](http://www.agilent.com/find/agilentdirect)

Quickly choose and use your test equipment solutions with confidence.

### Agilent T&M Software and Connectivity

Agilent's Test and Measurement software and connectivity products, solutions and developer network allows you to take time out of connecting your instruments to your computer with tools based on PC standards, so you can focus on your tasks, not on your connections. Visit [www.agilent.com/find/connectivity](http://www.agilent.com/find/connectivity) for more information.

For more information on Agilent Technologies' products, applications or services, please contact your local Agilent office. The complete list is available at:

[www.agilent.com/find/contactus](http://www.agilent.com/find/contactus)

#### Phone or Fax

##### United States:

(tel) 800 829 4444  
(fax) 800 829 4433

##### Canada:

(tel) 877 894 4414  
(fax) 800 746 4866

##### China:

(tel) 800 810 0189  
(fax) 800 820 2816

##### Europe:

(tel) 31 20 547 2111

##### Japan:

(tel) (81) 426 56 7832  
(fax) (81) 426 56 7840

##### Korea:

(tel) (080) 769 0800  
(fax) (080) 769 0900

##### Latin America:

(tel) (305) 269 7500

##### Taiwan:

(tel) 0800 047 866  
(fax) 0800 286 331

##### Other Asia Pacific Countries:

(tel) (65) 6375 8100  
(fax) (65) 67556 0042  
Email: [tm\\_ap@agilent.com](mailto:tm_ap@agilent.com)

Contacts revised: 1/12/05

Product specifications and descriptions in this document subject to change without notice.

© Agilent Technologies, Inc. 2005

Printed in USA April 20, 2005

5989-0421EN

