

Agilent Technologies 1670G Series Benchtop Logic Analyzers

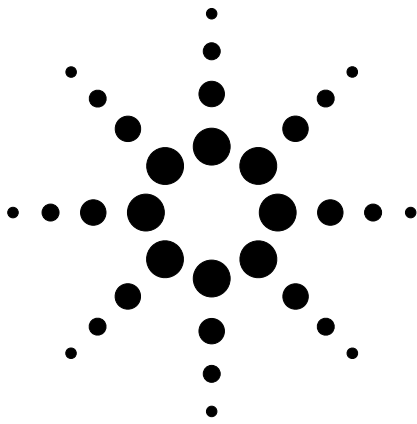

Technical Data

Affordable logic analyzers designed for your exact needs

Agilent Technologies 1670G Series benchtop logic analyzers enable design engineers to purchase a logic analyzer that meets their exact needs and their budget.

The 1670G Series models have the option of a built-in, 500 MHz, 2 GSa/s oscilloscope that can be triggered by the logic analyzer. Some of the toughest hardware debug problems can be found only with the digital triggering capabilities of a logic analyzer and can be solved only with the analog resolution of an oscilloscope.

An optional pattern generator in the 1670G Series allows designers to substitute stimulus for missing subsystems during product development.

The 1670G Series helps simplify the capture and analysis of complex events with optional 256K or 2M deep memory. Deep memory is a valuable logic analyzer feature for debugging embedded microprocessor systems.



Figure 1. Agilent's 1670G Series Benchtop Logic Analyzers Offer Deep Memory and Integrated Oscilloscope or Pattern Generator Options.

Agilent Model Number	1670G	1671G	1672G	1673G
Channel count	136	102	68	34
Timing analysis speed	250/500 MHz (full/half channels)			
State analysis speed	150 MHz			
State clock/qualifiers	4			2
Memory depth/channel ^[3]	64/128K (full/half channels)			
with option 1 ^[1] , ^[3]	256/512K			
with option 2 ^[3]	2/4M			
Option 3 ^[2] (oscilloscope)	2-channel, 500 MHz, 2 GSa/s, 32K sample oscilloscope			
Option 4 (pattern generator)	32-channel, 100/200 MHz, 256K vector pattern generator			
Built-in display	color			
LAN port	Thin LAN & Ethertwist			

^[1] Choose memory option 1 or 2.

^[2] Choose either the scope or the pattern generator (compatible with option 1 or 2).

^[3] Time or state tags halve the acquisition memory when there are no unassigned pods.

The units include a VGA resolution color flat panel display to help you find information quickly. The user interface helps to locate the source of design-problems in less time. You have the option of using a mouse or

the front panel to easily navigate through the user interface; a PC style keyboard is also supported. A compact all-in-one design helps save space on a crowded lab bench.



Agilent Technologies

Agilent Technologies 1670G Series Specifications

Features	Benefits
State/timing analyzer	Select the number of channels to match your application (34, 68, 102, 136).
Optional deep memory	256K or 2M of memory allows capture and analysis of much longer periods of execution. Helps solve poorly understood or difficult to reproduce problems.
Optional oscilloscope	An integrated oscilloscope can be triggered from the analyzer (and vice versa) and provides the ability to view analog and digital signals simultaneously.
Optional pattern generator	An integrated pattern generator provides stimulus for missing components, so that testing can begin before the system is complete.
Trigger functions	Trigger functions are depicted graphically and textually, and may be combined to create custom trigger sequences for capturing a complex series of events.
Global markers	Track a symptom in one domain (e.g. timing) to its cause in another domain (e.g. analog).
Documentation capability	Save screen shots in standard TIFF, PCX, and EPS formats on disk. Print screen shots and trace listings to a local printer. Save acquired data in ASCII format for post processing.
Processor and bus support	Quickly and reliably connect to a wide variety of specific processors and buses. Inverse assemblers allow data to be viewed at the assembly level.
LAN	Ethertwist and ThinLAN connectors support FTP, PC/NFS protocols, and work with X11 windows packages. Users can program the analyzer, archive data, and setup files via telnet sockets.
Probing	A wide variety of IC clips, QFP adapters, QFP probes, and headers are available to help connect the analyzer to the system under test.

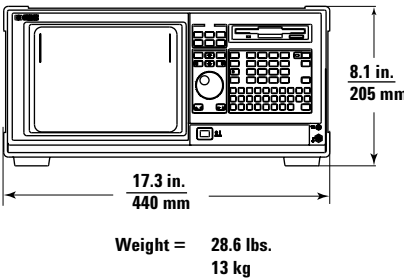
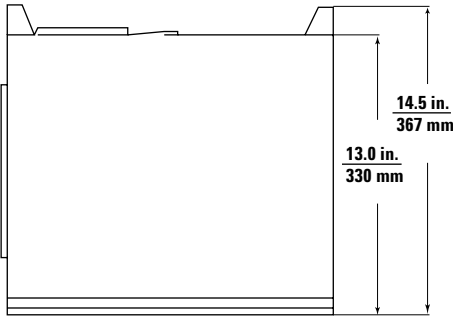

Figure 2. Logic Analyzer Dimensions and Weight

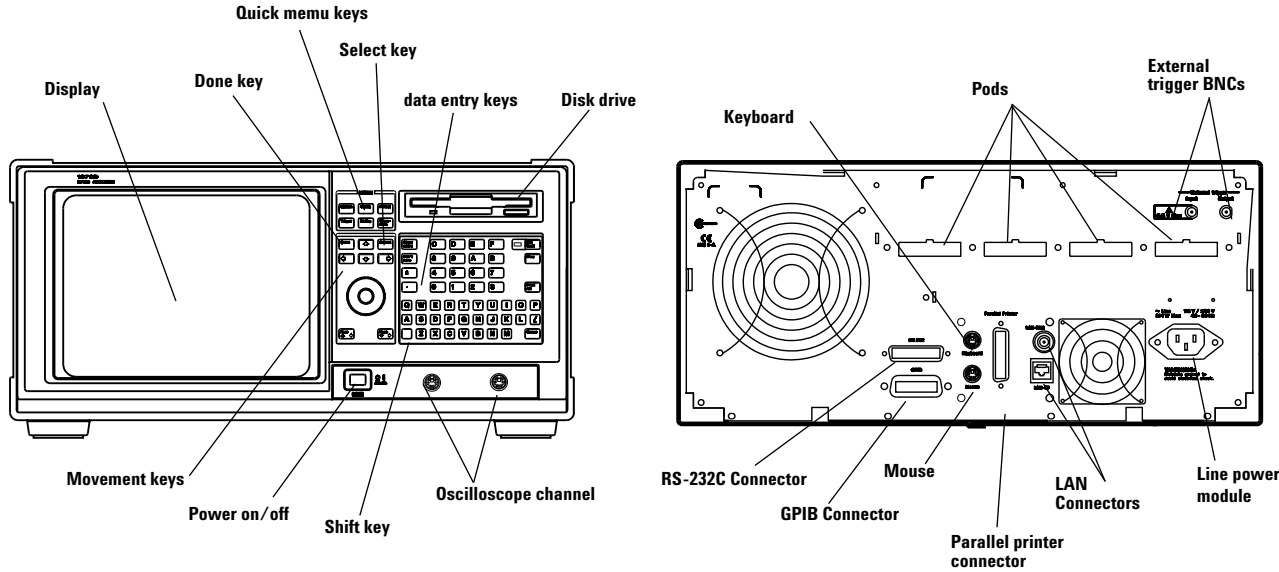
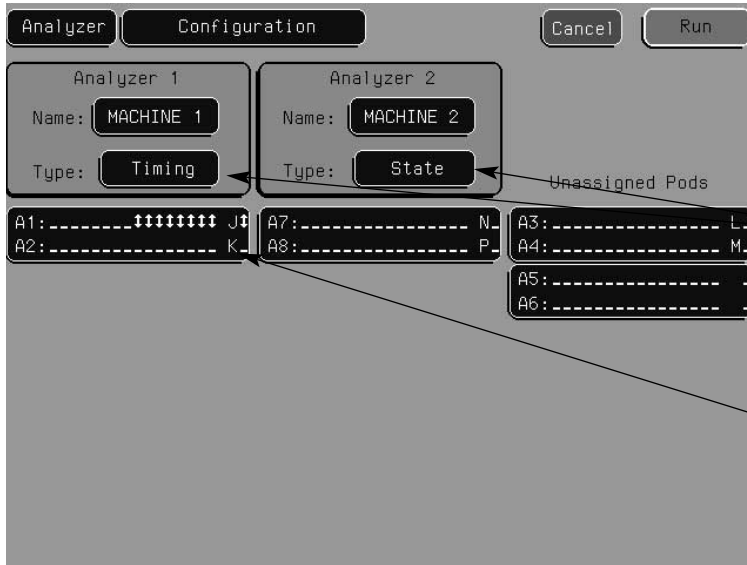

Figure 3. Diagram of Logic Analyzer's Front and Rear Panels

Agilent Technologies 1670G Series Annotated Screen Shots



Run—starts data acquisition in specified trace mode.

Stop—halts acquisition and displays current data.

Acquisition mode and number of channels (assign pods) are specified. Timing and State measurements can be taken simultaneously.

Activity indicators allow users to monitor device-under-test activity during analyzer setup.

Figure 4. Configuration Screen

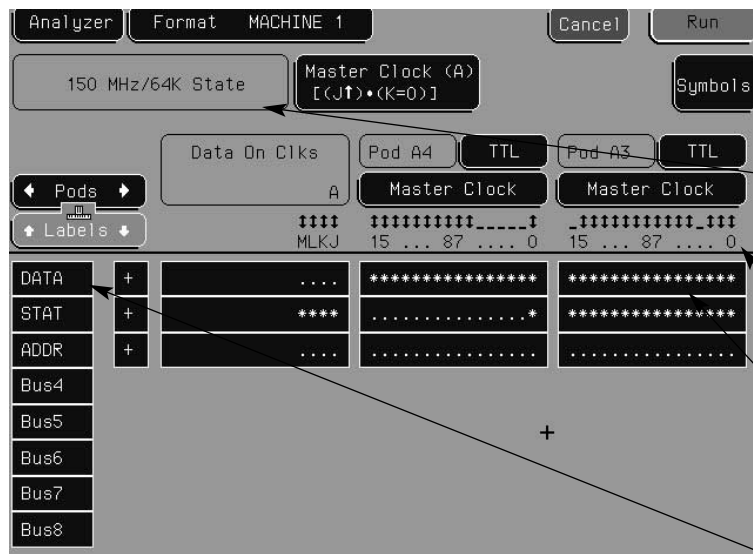

User mnemonics defined (for bit patterns or ranges), or up to 1000 symbols extracted from popular object module formats. In symbol mode, symbols will be displayed in place of data.

Logic threshold levels.

State speed can be specified when analyzer is in state mode. Full channel (250 MHz) or half channel (500 MHz) can be specified in timing mode. (Screen shot is in state mode.)

Activity indicators.

Appropriate channels assigned to a label.

Channels can be grouped and given a 6-character label. Maximum of 126 labels with up to 32 channels each.

Figure 5. Format Screen

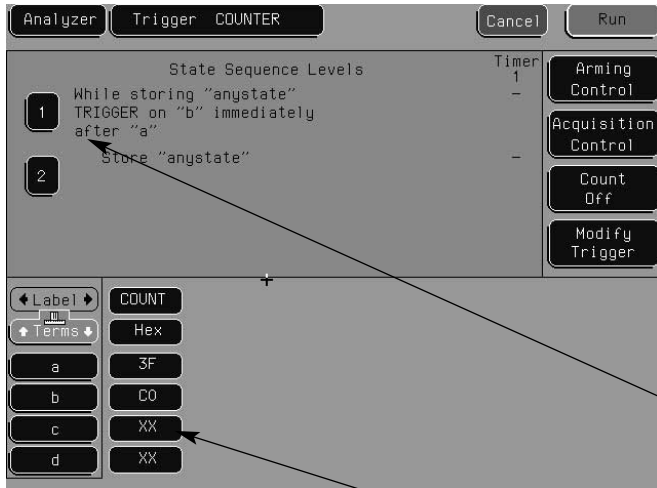

Figure 6. Trigger Screen

Analyzer and oscilloscope or pattern generator can cross-arm each other. Arming is started by Run, Group Run, or the PortIn BNC (rising edge). PortOut is asserted as a rising edge at the PortOut BNC.

Twenty-three trigger functions (shown graphically and textually) can be combined to create custom trigger sequences.

Up to twelve sequence levels with branching and timers can be defined.

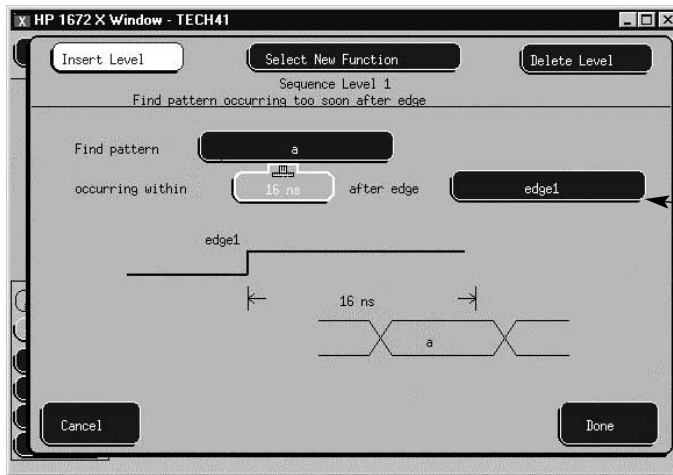

Figure 7. Graphical Trigger Function

Ten pattern recognizers (and bit patterns in each label) can be defined.

Edge terms make it easy to trigger on rising or falling edges on any number of specified signals. They can also be used to trigger on glitches to 3.5 ns.

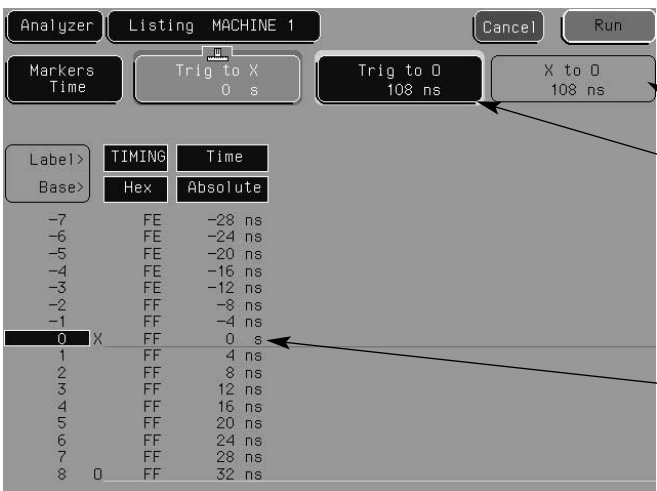

Figure 8. Listing Display

Knob (or hold down right mouse button) scrolls through listing display.

Markers measure the time between events, search for specific events, and gather statistical data.

Trigger is located at line 0.

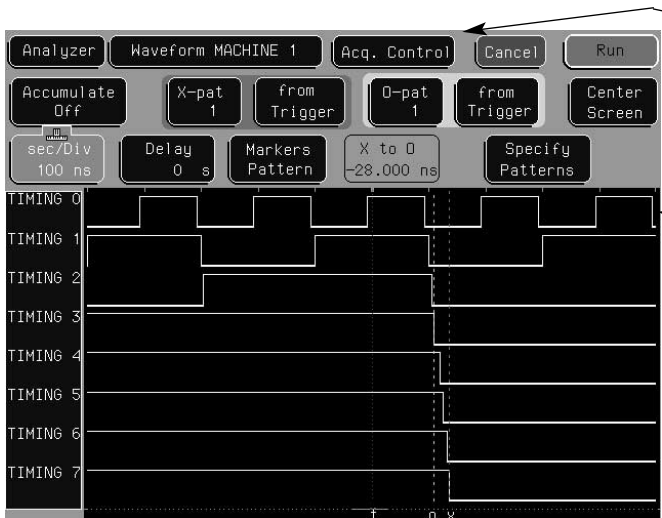

Figure 9. Waveform Display

Accumulate—waveform is not erased between successive acquisitions (persistence).

All displays are time-correlated, so the trigger, x, and o markers are located at equivalent positions in time on each display.

Overlay—multiple channels displayed on one line, with value in selected base if space permits. Maximum of 24 lines per screen; may scroll through up to 96 lines.



Figure 10. Chart Display (State Mode Only)

Chart mode plots the value of a specified label (on y-axis) versus a state number or another label (on x-axis). Both axes can be scaled. Useful for A/D converters and obtaining a visual overview of bus activity (address flow or data flow).



Figure 11. System Performance Analyzer (SPA)

There are three SPA modes available: State Overview (shown here provides a visual indication of memory use), State Histogram (% time spent in each function), and Time Interval (execution time of a particular function).

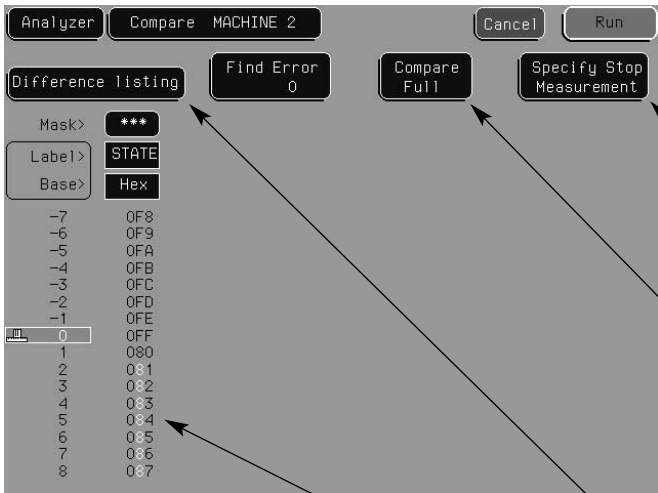

Figure 12. Compare Screen (State Mode Only)

Compare performs a post-processing, bit-by-bit comparison of acquired state data and compare image data. Copy state acquisition into compare image buffer (may edit any bit in compare image). The compare feature halves the memory depth (1/4 memory with Opt. 002)

Stop Measurement halts repetitive acquisitions when current and compare acquisitions are equal or not equal.

Compare Partial allows masking of a compare image in order to compare only certain bits or set ranges of states (rows). (It compares data that falls within enabled channels and specified range.)

Difference Listing highlights differences between the current state listing and compare image. (Reference listing shows compare image and bit masks.)

Several different views of the oscilloscope display are available, each offering different control options. The Scope Channel display is shown here.

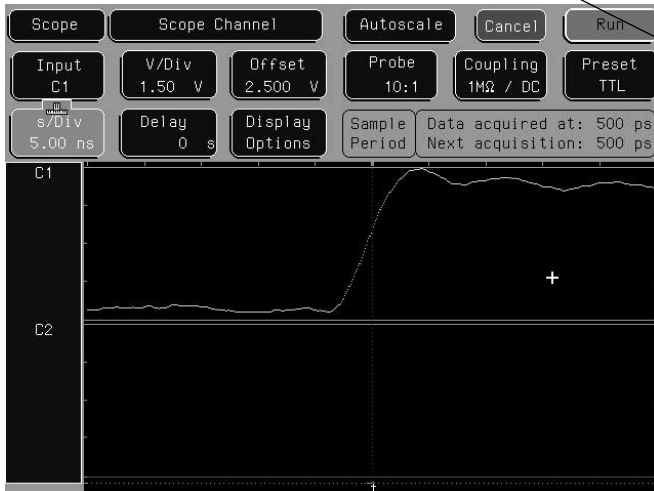

Figure 13. Oscilloscope Display (Option 003)



Figure 14. Pattern Generator Sequence Window (Option 004)

The pattern generator allows the user to create data streams from provided macros or from various external sources and use them to stimulate a target. Since the pattern generator is internal to the logic analyzer, the target response can be measured with the logic analyzer to identify incorrect output and potential target system malfunction.

Agilent Technologies 1670G Series Specifications and Characteristics

Probes (general-purpose lead set)

Input resistance	100 k Ω , $\pm 2\%$
Parasitic tip capacitance	1.5 pF
Minimum voltage swing	500 mV, peak-to-peak
Threshold accuracy*	$\pm(100 \text{ mV} + 3\% \text{ of threshold setting})$
Maximum input voltage	$\pm 40 \text{ V}$ peak

State Analysis

Minimum state clock pulse width	3.5 ns
Time tag resolution ^[3]	8 ns or $\pm 0.1\%$ (whichever is greater)
Maximum time count between states	34.4 seconds
Maximum state tag count between states ^[3]	4.29×10^9 states
Minimum master-to-master clock time*	6.67 ns
Minimum master-to-slave clock time	0.0 ns
Minimum slave-to-master clock time	4.0 ns
Clock qualifier setup/hold	4.0/0 ns fixed

Timing Analysis

Sample period accuracy	0.01% of sample period
Channel-to-channel skew	2 ns typical (not > 3 ns)
Time interval accuracy	\pm (sample period accuracy + channel-to-channel skew + 0.01% of time interval reading)
Minimum detectable glitch	3.5 ns

Triggering

Sequencer speed	>150 MHz
Maximum occurrence counter	1,048,575
Range width	32 bits each
Timer value range	400 ns to 500 seconds
Timer resolution	16 ns or 0.1% (whichever is greater)
Timer accuracy	$\pm 32 \text{ ns}$ or $\pm 0.1\%$ (whichever is greater)

Operating Environment

Temperature	Instrument: 0°C to 55°C (+32°F to 131°F) Disk media: 10°C to 40°C (+50°F to 104°F) Probe lead sets and cables: 0°C to 65°C (+32°F to 149°F)
Humidity	Instrument: up to 95% relative humidity at +40°C Disk media and hard drive: 8% to 85% relative humidity
Altitude	4,572 m (15,000 ft)

^[3] Time or state tags halve the acquisition memory when there are no unassigned pods.

* Warranted Specifications

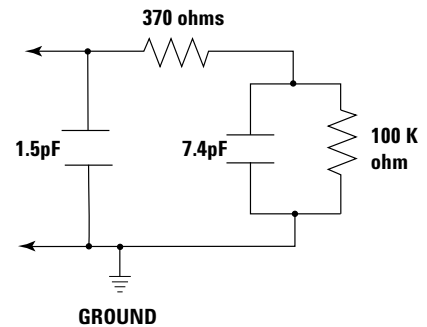

Figure 15. Equivalent Probe Load for the 01650-61608 General-Purpose Lead Set.

PortIn arms logic analyzer	15 ns typical delay from signal input to a don't care logic analyzer trigger
PortIn arms oscilloscope	40 ns typical delay from signal input to an immediate oscilloscope trigger.
Logic analyzer arms PortOut	120 ns typical delay from logic analyzer trigger to signal output.
Oscilloscope arms PortOut	60 ns typical delay from oscilloscope trigger to signal output
Arming skew	Correction factors for nominal skew between displayed timing and oscilloscope signals are built into the operating system. Additional correction for unit-by-unit variation can be made using the Skewfield. An entered skew value effects the next (not the present) acquisition display.

Timing Analysis

Conventional timing	Minimum sample period 4 ns / 2 ns, maximum sample period 10 μ s / 2.5 μ s. Time covered = sample period x memory depth.
Printing	Screen images can be printed in black and white or color from all menus using the Print field. State or timing listings can also be printed in full or part (starting from center screen) using the Print All selection. Printers that use the HP Printer Control Language (PCL) and have a parallel Centronics, RS-232, or GPIB interface are supported. Supported printers: HP DeskJet, LaserJet, QuietJet, PaintJet, and ThinkJet models, as well as Epson FX80, LX80, and MX80 printers with RS-232 or Centronics interfaces in Epson 8-bit graphics mode.
Mass storage	2 GB internal hard disk drive, 1.44 Mbyte, 3.5-inch flexible disk drive. The logic analyzer's operating system resides in Flash ROM and can be updated from the flexible disk drive or from the internal hard disk drive.
File formats	TIFF, color PCX, or black and white Encapsulated Adobe $\text{\textcircled{C}}$ PostScript $\text{\textcircled{C}}$ (EPS) formats
Config files	Logic analyzer and oscilloscope files that include configuration and data information (if present) are encoded in a binary format. They can be stored to or loaded from the hard disk drive or a flexible disk. Binary format configuration/data files are stored with the time of acquisition and the time of storage

Trigger Resources

Patterns	10
Ranges	2
Edge and glitch	2 terms (timing only)
Timers	2
Occurrence counters	4
Trigger sequence levels	12 state / 10 timing
Setup/hold time	3.5/0 ns to 0/3.5 ns in .5 ns increments
Threshold range	TTL, ECL, user-definable ± 6.0 V adjustable in 50 mV increments

Adobe $\text{\textcircled{C}}$ PostScript $\text{\textcircled{C}}$ is a registered trademark of Adobe Systems Incorporated.

Agilent Technologies 1670G Series (Option 003) Oscilloscope Specifications and Characteristics

General Information

Model number	1670G Option 003
Number of channels	2
Maximum sample rate	2 GSa/s per channel
Bandwidth ^{[4] [8]}	dc to 500 MHz (real time, dc coupled)
Rise time ^{[5] [8]}	700 ps
Vertical resolution	8 bits full scale
Memory depth	32K samples

Oscilloscope Probing

Input coupling	1 M Ω : ac,dc 50 Ω : dc only
Input resistance ^[8]	1M Ω \pm 1% 50 Ω \pm 1%
Input capacitance	~ 7pF
Probes included	Two Agilent 1160A probes; (10:1, 10 M Ω 9 pF 1.5 meters)

Vertical (at BNC)

Maximum safe input voltage	1 M Ω : \pm 250 V 50 Ω : 5 V rms
Vertical sensitivity range (1:1 Probe)	16 mV full scale to 40 V full scale
Probe factors	Any integer ratio from 1:1 to 1000:1
Vertical (dc) gain accuracy ^[6]	\pm 1.25% of full scale
dc offset range (1:1 probe)	\pm 2V to \pm 250V (depending on the vertical sensitivity)
dc offset accuracy ^[8]	\pm [1.0% of channel offset + 2.0% of full scale]
Voltage measurement accuracy ^[8]	\pm [1.25% of full scale + offset accuracy + 0.016 V/div]
Channel-to-channel isolation	dc to 50 MHz – 40 dB; 50 MHz to 500 MHz – 30 dB

^[4] Upper bandwidth reduces by 2.5 MHz for every degree C above 35°C.

^[5] Rise time calculated as $t_r = \frac{0.35}{\text{bandwidth}}$

^[6] Vertical gain accuracy decreases 0.08% per degree C from software calibration temperature.

^[7] Specification applies at the maximum sampling rate. At lower rates, replace 150 ps in the formula with (0.15 x sample interval) where sample interval is defined as 1/sample rate.

^[8] Specifications valid within \pm 10°C of auto-calibration temperature.

Horizontal

Time base range	0.5 ns/div to 5 s/div
Time interval measurement accuracy [7] [8]	$\pm [(0.005\% \text{ of } \Delta t) + (2 \times 10^{-6} \times \text{delay setting}) + 150 \text{ ps}]$

Oscilloscope Triggering

Trigger level range	Bounded within channel display window
Trigger sensitivity [8]	dc to 50 MHz: 0.063 x Full Scale 50 MHz to 500 MHz: 0.125 x Full Scale
Trigger modes	
Immediate	Triggers immediately after arming condition is met. (Arming condition is Run, Group Run, Cross Arming Signal, or Port In BNC signal).
Edge	Triggers on rising or falling edge from channel 1 or 2.
Pattern	Triggers on entering or exiting logical pattern specified across channels 1 or 2. Each channel can be specified as high (H), low (L), or don't care (X) with respect to the level settings in the edge trigger menu. Patterns must be >1.75 ns in duration to be recognized.
Time-qualified pattern	Triggers on the exiting edge of a pattern that meets the user-specified duration criterion. Greater than, less than, or within range duration criterion can be used. Duration range is 20 ns to 160 ns. Recovery time after valid patterns with invalid duration is <12 ns.
Events delay	Triggers on the nth edge or pattern as specified by the user. Time-qualification is applied only to the 1st of n patterns.
Auto-trigger	Self-triggers if no trigger condition is found ~ 50 ms after arming.

Measurement Functions

Time markers	Two markers (x and o) measure time intervals manually, or automatically with statistics.
Voltage markers	Two markers (a and b) measure voltage and voltage differences.
Automatic measurements	Period, frequency, rise time, fall time, +width, -width, peak-to-peak voltage, overshoot, and undershoot.

[4] Upper bandwidth reduces by 2.5 MHz for every degree C above 35°C.

[5] Rise time calculated as $t_r = \frac{0.35}{\text{bandwidth}}$

[6] Vertical gain accuracy decreases 0.08% per degree C from software calibration temperature.

[7] Specification applies at the maximum sampling rate. At lower rates, replace 150 ps in the formula with (0.15 x sample interval) where sample interval is defined as 1/sample rate.

[8] Specifications valid within $\pm 10^\circ\text{C}$ of auto-calibration temperature.

Agilent Technologies 1670G Series (Option 004) Pattern Generator Specifications and Characteristics

Maximum memory depth	258,048 vectors
Number of output channels at 100 MHz to 200 MHz clock	16
Number of output channels at ≤100 MHz clock	32
Maximum number of labels	126
Maximum width of a label	32 bits
Maximum number of "IF Condition" blocks at ≤50 MHz clock	1
Maximum number of different macros	100
Maximum number of lines in a macro	1024
Maximum number of parameters in a macro	10
Maximum number of macro invocations	1,000
Maximum loop count in a repeat loop	20,000
Maximum number of repeat loop invocations	1,000
Maximum number of wait event patterns	4
Number of input lines to define a wait pattern	3

Lead Set Characteristics

10474A 8-channel probe lead set	Provides most cost effective lead set for the 1670G Series clock and data pods. IC clips are not included.
10347A 8-channel probe lead set	Provides 50 Ω coaxial lead set for unterminated signals, required for Agilent 10465A ECL Data Pod (unterminated). IC clips are not included.

Data Pod Characteristics

10461A TTL Data Pod

Output type	10H125 with 100 Ω series
Maximum clock	200 MHz
Skew (note 1)	typical < 2 ns; worst case = 4 ns
Recommended lead set	Agilent 10474A

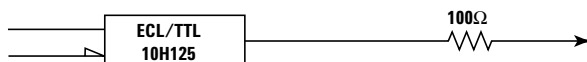

10462A 3-STATE TTL/CMOS Data Pod

Output type (note 2)	74ACT11244 with 100 Ω series; 10H125 on non 3-state channel 7
3-State enable	negative true, 100 KΩ to GND, enabled on no connect
Maximum clock	100 MHz
Skew (note 1)	typical < 4 ns; worst case = 12 ns
Recommended lead set	Agilent 10474A



Note 1: Typical skew measurements made at pod connector with approximately 10 pF/50 kΩ load to GND; worst case skew numbers are a calculation of worst case conditions through circuits.

Note 2: Channel 7 on the 3-state pods has been brought out in parallel as a non 3-state signal. By looping this output back into the 3-state enable line, the channel can be used as a 3-state enable.

10464A ECL Data Pod (Terminated)

Output type	10H115 with 330 Ω pulldown, 47 Ω series
Maximum clock	200 MHz
Skew (note 1)	Typical < 1 ns; worst case = 2 ns
Recommended lead set	Agilent 10474A

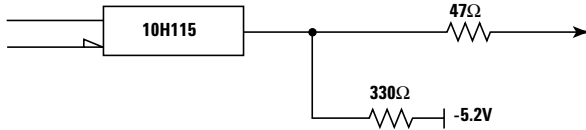

10465A ECL Data Pod (Unterminated)

Output type	10H115 (no termination)
Maximum clock	200 MHz
Skew (note 1)	Typical < 1 ns; worst case = 2 ns
Recommended lead set	Agilent 10347A

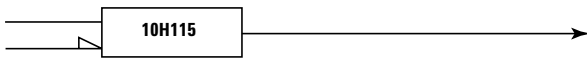

10469A 5 Volt PECL Data Pod

Output type	100EL90 (5V) with 348 Ω pulldown to ground and 42 Ω in series
Maximum clock	300 MHz
Skew (note 1)	Typical < 500 ps; worst case = 1 ns
Recommended lead set	Agilent 10498A

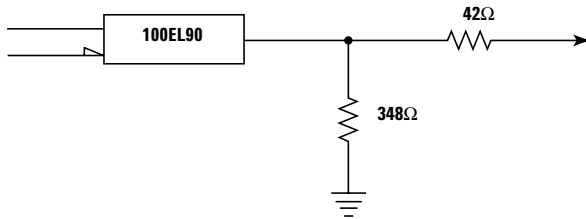

10471A 3.3 Volt LVPECL Data Pod

Output type	100LVEL90 with 215 Ω pulldown to ground and 42 Ω in series
Maximum clock	300 MHz
Skew (note 1)	Typical < 500 ps; worst case = 1 ns
Recommended lead set	Agilent 10498A

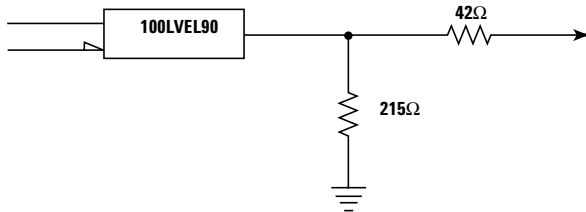

Note 1: Typical skew measurements made at pod connector with approximately 10 pF/50 k Ω load to GND; worst case skew numbers are a calculation of worst case conditions through circuits.

Note 2: Channel 7 on the 3-state pods has been brought out in parallel as a non 3-state signal. By looping this output back into the 3-state enable line, the channel can be used as a 3-state enable.

10473A 3-STATE 2.5 Volt Data Pod

Output type	74AVC16244
3-state enable	negative true, 38K Ω to GND, enable on no connect
Maximum clock	300 MHz
Skew (note 1)	typical < 1.5 ns; worst case = 2 ns
Recommended lead set	Agilent 10498A

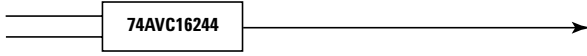

10476A 3-STATE 1.8 Volt Data Pod

Output type	74AVC16244
3-state enable	negative true, 38K Ω to GND, enable on no connect
Maximum clock	300 MHz
Skew (note 1)	typical < 1.5 ns; worst case = 2 ns
Recommended lead set	Agilent 10498A

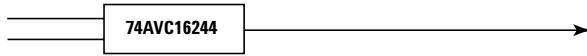

10483A 3-STATE 3.3 Volt Data Pod

Output type	74AVC16244
3-state enable	negative true, 38K Ω to GND, enable on no connect
Maximum clock	300 MHz
Skew (note 1)	typical < 1.5 ns; worst case = 2 ns
Recommended lead set	Agilent 10498A



Note 1: Typical skew measurements made at pod connector with approximately 10 pF/50 k Ω load to GND; worst case skew numbers are a calculation of worst case conditions through circuits.

Note 2: Channel 7 on the 3-state pods has been brought out in parallel as a non 3-state signal. By looping this output back into the 3-state enable line, the channel can be used as a 3-state enable.

Data Cable Characteristics Without a Data Pod

The Agilent pattern generator data cables without a data pod provide an ECL terminated (1 K Ω to -5.2V) differential signal (from a type 10E156 or 10E154 driver). These are usable when received by a differential receiver, preferably with a 100 Ω termination across the lines. These signals should not be used single ended due to the slow fall time and shifted voltage threshold (they are not ECL compatible).

Agilent 1670C-Series (Option 004) Data Cable Output

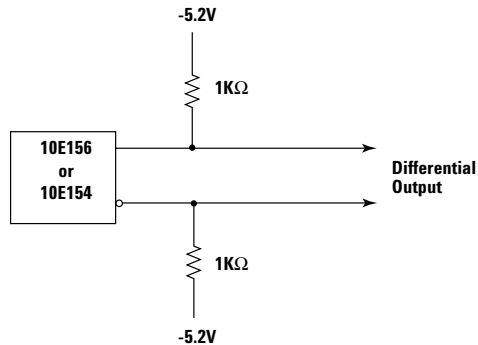

Clock Pod Characteristics

10460A TTL Clock Pod

Clock output type	10H125 with 47 Ω series; true & inverted
Clock output rate	100 MHz maximum
Clock out delay	11 ns maximum in 9 steps
Clock input type	TTL – 10H124
Clock input rate	dc to 100 MHz
Pattern input type	TTL – 10H124 (no connect is logic 1)
Clock-in to clock-out	approximately 30 ns
Pattern-in to recognition	approx. 15 ns + 1 clk period
Recommended lead set	Agilent 10474A

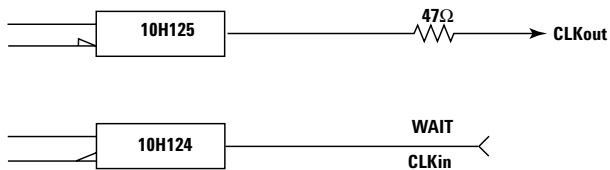

10463A ECL Clock Pod

Clock output type	10H116 differential unterminated; and differential with 330 Ω to –5.2V and 47 Ω series
Clock output rate	200 MHz maximum
Clock out delay	11 ns maximum in 9 steps
Clock input type	ECL – 10H116 with 50 K Ω to –5.2V
Clock input rate	dc to 200 MHz
Pattern input type	ECL – 10H116 with 50 K Ω (no connect is logic 0)
Clock-in to clock-out	approximately 30 ns
Pattern-in to recognition	approx. 15 ns + 1 clk period
Recommended lead set	Agilent 10474A

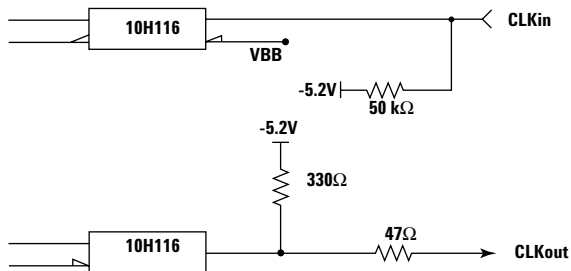

10468A 5 Volt PECL Clock Pod

Clock output type	10EL90 (5V) with 348 Ω pulldown to ground and 42 Ω in series
Clock output rate	300 MHz maximum
Clock out delay	11 ns maximum in 9 steps
Clock input type	100EL91 PECL (5V), no termination
Clock input rate	dc to 300 MHz
Pattern input type	100EL91 PECL (5V), no termination (no connect is logic 0)
Clock-in to clock-out	approximately 30 ns
Pattern-in to recognition	approx. 15 ns + 1 clk period
Recommended lead set	Agilent 10498A

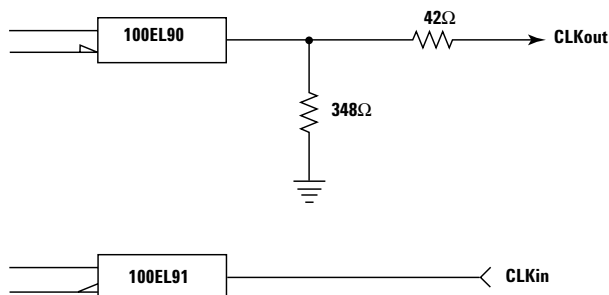

10470A 3.3 Volt LVPECL Clock Pod

Clock output type	10LVEL90 (3.3V) with 215 Ω pull-down to ground and 42 Ω in series
Clock output rate	300 MHz maximum
Clock out delay	11 ns maximum in 9 steps
Clock input type	100LVEL91 LVPECL (3.3V), no termination
Clock input rate	dc to 300 MHz
Pattern input type	100LVEL91 LVPECL (3.3V), no termination (no connect is logic 0)
Clock-in to clock-out	approximately 30 ns
Pattern-in to recognition	approx. 15 ns + 1 clk period
Recommended lead set	Agilent 10498A

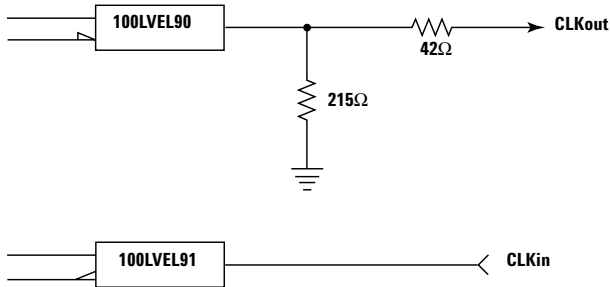

10472A 2.5 Volt Clock Pod

Clock output type	74AVC16244
Clock output rate	200 MHz maximum
Clock out delay	11 ns maximum in 9 steps
Clock input type	74AVC16244 (3.6V max.)
Clock input rate	dc to 200 MHz
Pattern input type	74AVC16244 (3.6V max; no connect is logic 0)
Clock-in to clock-out	approximately 30 ns
Pattern-in to recognition	approx. 15 ns + 1 clk period
Recommended lead set	Agilent 10498A

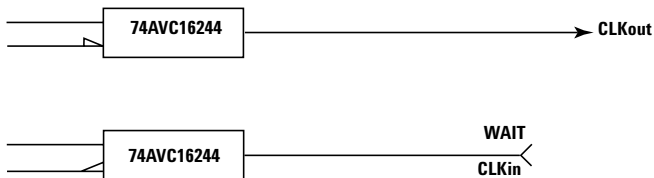

10475A 1.8 Volt Clock Pod

Clock output type	74AVC16244
Clock output rate	200 MHz maximum
Clock out delay	11 ns maximum in 9 steps
Clock input type	74AVC16244 (3.6V max.)
Clock input rate	dc to 200 MHz
Pattern input type	74AVC16244 (3.6V max; no connect is logic 0)
Clock-in to clock-out	approximately 30 ns
Pattern-in to recognition	approx. 15 ns + 1 clk period
Recommended lead set	Agilent 10498A

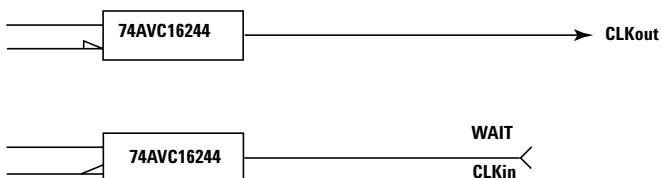

10477A 3.3 Volt Clock Pod

Clock output type	74AVC16244
Clock output rate	200 MHz maximum
Clock out delay	11 ns maximum in 9 steps
Clock input type	74AVC16244 (3.6V max.)
Clock input rate	dc to 200 MHz
Pattern input type	74AVC16244 (3.6V max; no connect is logic 0)
Clock-in to clock-out	approximately 30 ns
Pattern-in to recognition	approx. 15 ns + 1 clk period
Recommended lead set	Agilent 10498A

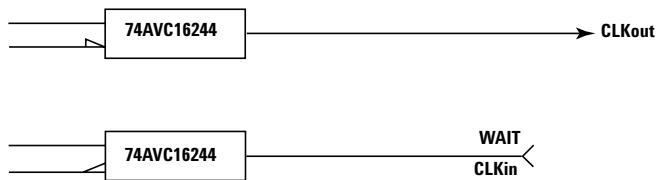

Probing Alternatives

Probing the device under test is both one of the potentially most difficult and certainly one of the most important tasks in debugging a digital design. That is why Agilent Technologies provides a wider variety of probing solutions than anyone else in the industry—each with a different set of advantages particular to a given situation. We like to think of it as helping you get your signals off to a great start.

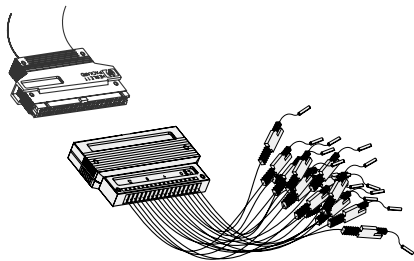

Figure 16. General-Purpose Lead Sets



Figure 17. Surface Mount IC Clips

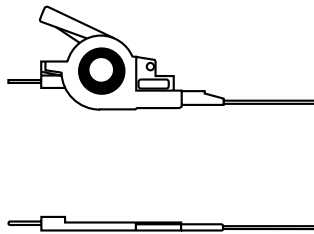

Figure 18. Ultra-Fine Pitch Surface Mount Device Clips

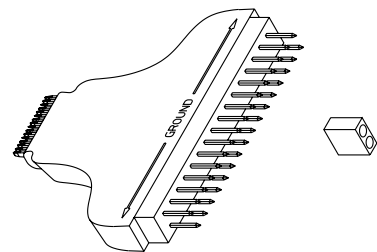

Figure 19. Agilent Wedge Probe Adapters for QFP Package

Probing Alternative	Advantages	Limitations
General-Purpose Lead Sets and Surface Mount IC Clips (Figure 16 and 17)	Most flexible method. Works in conjunction with SMD clips and Wedge adapters listed below. Included with logic analyzer purchase.	Can be cumbersome when connecting a large number of channels.
Ultra-Fine Pitch Surface Mount Device Clips (Figure 18)	Smallest IC clips in the industry to date (down to 0.5 mm). Works with both logic analyzer and scope probing systems.	Same as above plus small incremental cost.
Wedge probe adapter for QFP Packages (Figure 19)	Compressible dual conductors between adjacent IC legs make 3-16 adjacent signal leads available to logic analyzer and scope probing systems.	Same as above plus small incremental cost.
Elastomeric and Locator Base Solutions for Generic QFP Packages (Figure 20)	Provides access to all signal leads for generic QFP packages (including custom ICs). Uses combination of one probe adapter and four flexible adapters, plus general-purpose lead sets.	Requires minimal keep out area. Moderate to significant incremental cost.
Direct Connection to Device Under Test via Built-In Connectors (Figure 21 and 22)	Very reliable and convenient probing system when frequent probing connections are required (manufacturing or field test for example). Connectors can be located at optimal position in the device under test. Can work in conjunction with Agilent provided inverse assemblers.	Requires advance planning to integrate into design process. Moderate (normal density) to significant (high density) incremental cost.
Analysis Probes for Specific Processors and Buses	Support for over 200 different processors and buses. Includes reliable logic analyzer probe pod connectors, logic analyzer configuration files and device specific inverse assemblers.	Requires moderate clearance around processor or bus. Moderate to significant extra cost depending on specific processor or bus.

Agilent Wedge Probe Adapter

IC leg spacing	Number of signals	Number of wedges in pack	Model number
0.5 mm	3	1	E2613A
0.5 mm	3	2	E2613B
0.5 mm	8	1	E2614A
0.5 mm	16	1	E2643A
0.65 mm	3	1	E2615A
0.65 mm	3	2	E2615B
0.65 mm	8	1	E2616A
0.65 mm	16	1	E2644A

Agilent Probing Solutions

Package type	Pin Pitch	Elastomeric Solutions
304-pin PQFP/CQFP	0.5 mm	
240-pin PQFP/CQFP	0.5 mm	E5363A probe adapter E5371A 1/4-flexible adapter
208-pin PQFP/CQFP	0.5 mm	E5374A probe adapter E5371A 1/4-flexible adapter
184-pin PQFP/CQFP	0.5 mm	
176-pin PQFP	0.5 mm	E5348A probe adapter E5349A 1/4-flexible adapter
160-pin QFP	0.5 mm	E5377A probe adapter E5349A 1/4-flexible adapter
160-pin PQFP/CQFP	0.65 mm	E5373A probe adapter E5349A 1/4-flexible adapter
144-pin PQFP/CQFP	0.65 mm	E5361A probe adapter E5340A 1/4-flexible adapter
144-pin TQFP	0.5 mm	E5336A probe adapter E5340A 1/4 flexible adapter

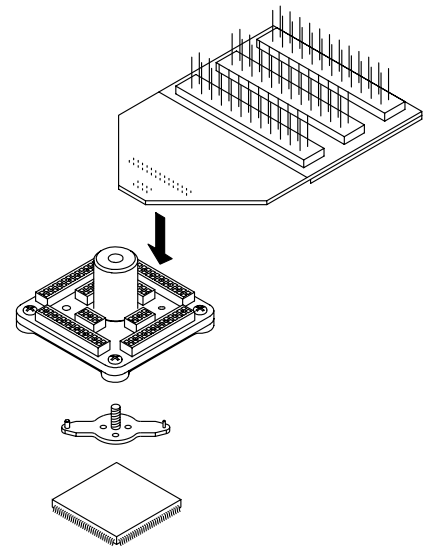

Figure 20. Elastomeric Probing Solution

Analysis Probes for Specific Processors and Buses

Please see *Processor and Bus Support for Agilent Logic Analyzers* (pub. no. 5966-4365E) for detailed information and ordering instructions for analysis probes. Also, see *Probing Solutions for Agilent Logic Analysis Systems* (pub. no. 5968-4632E) for more information on probing.

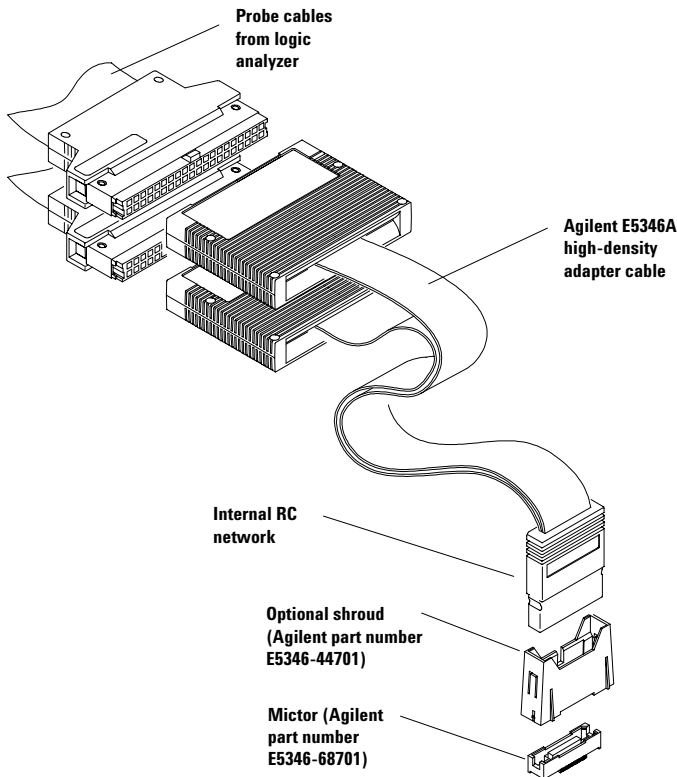

Figure 21. High-Density Direct Connection Solution

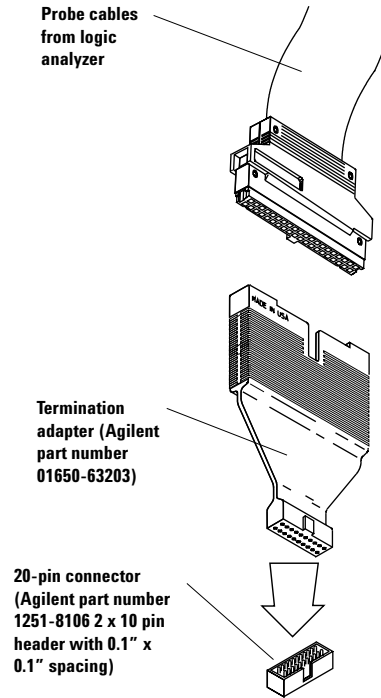

Figure 22. Normal-Density Direct Connection Solution

Accessories for the Agilent 1670G Series Logic Analyzers



Figure 23. Agilent 1182B Standard Testmobile

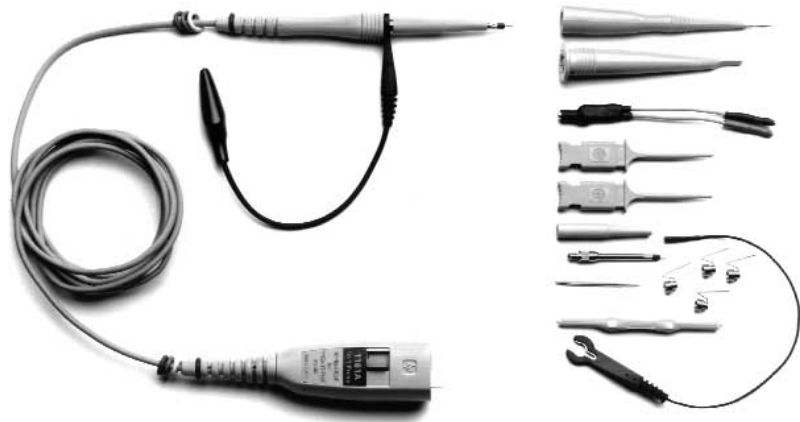

Figure 25. Agilent 1160 Probes and Accessories



Figure 24. Agilent 1184A Deluxe Testmobile

Oscilloscope Probes

Agilent 1160 Family of Miniature Passive Probes

The Agilent 1160 miniature probes were developed as a result of intensive market research. We developed a probe with a browser that won't slip off the test point being probed and short to some adjacent point. The browser uses a crown point that digs into solder and won't slip. These probes include a variety of ground leads and 50 mil SMD clips for attaching to different grounding points. Each 1670G Series logic analyzer with Option 003 ships with the 1160 family passive probes.

Each 1160 family probe includes:

- 1 probe assembly
- 1 general-purpose retractable hook tip
- 1 browser
- 2 barrel insulators
- 4 spring grounds
- 1 alligator ground lead
- 1 socketed ground lead
- 1 dual lead adapter
- 2 SMD IC clips
- 1 spare browser pogo pin
- 1 spare probe tip
- 1 screwdriver
- 1 users' reference
- 3-year warranty

The Agilent 1170A low-mass passive probe is also available. (See ordering information for Optional Oscilloscope Probes.)

Agilent 1670G Series Ordering Information

Agilent 1670G Series Benchtop Logic Analyzers

Analyzer	Description
1670G	136-Channel Color Logic Analyzer
1671G	102-Channel Color Logic Analyzer
1672G	68-Channel Color Logic Analyzer
1673G 3	4-Channel Color Logic Analyzer
Option 003	Oscilloscope Option
Option 004	Pattern Generator Option +
Option 005	Training Kit

Note: Customers may choose either a scope or a pattern generator (not both) and one memory option.

Agilent 1670G Series Product Options

Opt OB1 Additional User Manual
Opt OB3 Add Service Manual
Opt OBF Add Programming Manual
Opt ICM Rack Mount Kit
Opt IBP Standards Compliant Calibration
Opt ABJ Japanese Localization of User Manual
Opt UK9 Front Panel Cover
Opt W30 3-Year Extended Repair Service
Opt W50 5-Year Extended Repair Service

Product Options for the Pattern Generator (Option 004)

At least one clock pod and lead set must be ordered for the Agilent 16706 Series Option 004 (pattern generator).

Also, order a data pod for every eight output channels used. There is a total of one clock pod and four data pods on each 1670G Series pattern generator.

Option Number	Description
011	TTL clock pod and 12" lead set (10460A and 10474A)
013	3-state TTL/CMOS data pod and 12" lead set (10462A and 10474A)
014	TTL data pod and 12" lead set (10461A and 10474A)
015	2.5V clock pod and 6" lead set (10472A and 10498A)
016	2.5V 3-state data pod and 6" lead set (10473A and 10498A)
017	3.3V clock pod and 6" lead set (10477A and 10498A)
018	3-state TTL/3.3V data pod and 6" lead set (10483A and 10498A)
021	ECL clock pod and 12" lead set (10463A and 10474A)
022	ECL terminated pod and 12" lead set (10464A and 10474A)
023	ECL interminated pod and 50 S2 shield coaxial lead set (10465A and 10347A)
031	5V PECL clock pod and 6" lead set (10468A and 10498A)
032	5V PECL data pod and 6" lead set (10469A and 10498A)
033	3.3V LVPECL clock pod and 6" lead set (10470A and 10498A)
034	3.3V LVPECL data pod and 6" lead set (10471A and 10498A)
041	1.8 V clock pod and 6" lead set (10475 and 10498A)
042	1.8 V 3-state data pod and 6" lead set (10476 and 10498A)

Optional Oscilloscope Probes for Agilent 1670G Series Logic Analyzers with Option 003

1145A 2 Channel, 750 MHz Active Probes
1142A External Power Supply for Agilent 1145
1170A Low Mass Passive Probe

Agilent 1670G Series

Ordering Information (Cont.)

Probing Alternatives for Benchtop Logic Analyzers

10467-68701	0.5 mm SMD IC clips (Qty 4)
E2613A	Wedge, 0.5mm, 3 signal (Qty1)
E2613B	Wedge, 0.5mm, 3 signal (Qty 2)
E2614A	Wedge, 0.5mm, 8 signal (Qty 1)
E2643A	Wedge, 0.5 mm 16 signal (Qty 1)
E2615A	Wedge, 0.65mm, 3 signal (Qty1)
E2615B	Wedge, 0.65mm, 3 signal (Qty 2)
E2616A	Wedge, 0.65mm, 8 signal (Qty 1)
E2644A	Wedge, 0.65 mm, 16 signal (Qty 1)
E5346A	High-Density Termination Adapter
E5346-44701	Shroud for High-Density Termination Adapter
E5346-68701	Mictor High-Density Connector (Qty 5)
01650-63203	Normal-Density Termination Adapter
1251-8106	Normal-Density 20-pin Connector

Testmobiles for Benchtop Logic Analyzers

1182B	Standard Testmobile
1184A	Deluxe Testmobile

Accessories for Benchtop Logic Analyzers

E2427B	DIN (PC-Style) Keyboard
1540-1066	Soft Carrying Case
5062-7379	Rack Mount Kit (same as option ICM)

1670G Series Post Purchase Upgrades

The following two upgrades can be added to 1670G Series logic analyzer at a later date.

E2460GS	Upgrade to add two-channel, 500-MHz bandwidth, 2-GSa/s, 32K memory oscilloscope to a 1670G Series model
E2495G	Upgrade to add thirty-two channel, 100 MVectors/sec, 256K memory pattern generator to a 1670G Series model

Replacement Part Numbers for Logic Analyzer Probes

5959-9333	Five gray probe leads
5959-9334	Five short ground leads
01650-61608	General purpose (16-channel) lead set
5959-0288	Through-hole IC clips (package of 20)

Replacement Model Numbers for Pattern Generator Probing

As a convenience, the individual model numbers for the 1670G Series (Option 004 pattern generator) clock/data pods and lead sets are listed here. Normally these are ordered as product options at the time of purchase. They are listed here for any future needs that may arise.

10460A	TTL Clock Pod
10461A	TTL Data Pod
10462A	3-State TTL/CMOS Data Pod
10463A	ECL Clock Pod
10464A	ECL (Terminated) Data Pod
10465A	ECL (Unterminated) Data Pod
10468A	5V PECL Clock Pod
10469A	5V PECL Data Pod
10470A	3.3V LVPECL Clock Pod
10471A	3.3V LVPECL Data Pod10472A2.5V Clock Pod
10473A	3-State 2.5V Data Pod
10475A	1.8V Clock Pod
10476A	3-State 1.8V Data Pod
10477A	3.3V Clock Pod
10483A	3-State TTL/3.3V Data Pod
10347A	50-ohm Coaxial Probe Lead Set
10474A	Probe Lead Set
10498A	6" Probe Lead Set

Related Agilent Literature

Title	Publication Publication	Description Number
<i>Logic Analysis and Emulation Solutions Version 5.0</i>	CD-Rom	5965-7502E
<i>Processor and Bus Support for Agilent Logic Analyzers</i>	Configuration Guide	5966-4365E
<i>Probing Solutions for Agilent Logic Analysis Systems</i>	Product Overview	5968-4632E

Product Warranty

Agilent Technologies hardware products are warranted against defects in materials and workmanship for a period of one year from date of shipment. Some newly manufactured Agilent products may contain remanufactured parts, which are equivalent to new in performance. If you send us a notice of such defects during the warranty period, we will either repair or replace hardware products that prove to be defective.

Agilent software and firmware products that are designated by Agilent for use with a hardware product are warranted for a period of one year from date of shipment to execute their programming instructions when properly installed. If you send us notice of defects in materials or workmanship during the warranty period, we will repair or replace these products, so long as the defect does not result from buyer supplied hardware or interfacing. The warranty period is controlled by the warranty statement included with the product and begins on the date of shipment.

Agilent Technologies' Test and Measurement Support, Services, and Assistance

Agilent Technologies aims to maximize the value you receive, while minimizing your risk and problems. We strive to ensure that you get the test and measurement capabilities you paid for and obtain the support you need. Our extensive support resources and services can help you choose the right Agilent products for your applications and apply them successfully. Every instrument and system we sell has a global warranty. Two concepts underlie Agilent's overall support policy: "Our Promise" and "Your Advantage."

Our Promise

Our Promise means your Agilent test and measurement equipment will meet its advertised performance and functionality. When you are choosing new equipment, we will help you with product information, including realistic performance specifications and practical recommendations from experienced test engineers. When you receive your new Agilent equipment, we can help verify that it works properly and help with initial product operation.

Your Advantage

Your Advantage means that Agilent offers a wide range of additional expert test and measurement services, which you can purchase according to your unique technical and business needs. Solve problems efficiently and gain a competitive edge by contracting with us for calibration, extra-cost upgrades, out-of-warranty repairs, and onsite education and training, as well as design, system integration, project management, and other professional engineering services. Experienced Agilent engineers and technicians worldwide can help you maximize your productivity, optimize the return on investment of your Agilent instruments and systems, and obtain dependable measurement accuracy for the life of those products.

www.agilent.com/find/emailupdates

Get the latest information on the products and applications you select.



Agilent Email Updates

Agilent T&M Software and Connectivity

Agilent's Test and Measurement software and connectivity products, solutions and developer network allows you to take time out of connecting your instruments to your computer with tools based on PC standards, so you can focus on your tasks, not on your connections. Visit **www.agilent.com/find/connectivity** for more information.

For more information on Agilent Technologies' products, applications or services, please contact your local Agilent office. The complete list is available at:

www.agilent.com/find/contactus

Phone or Fax

United States:

(tel) 800 829 4444
(fax) 800 829 4433

Canada:

(tel) 877 894 4414
(fax) 800 746 4866

China:

(tel) 800 810 0189
(fax) 800 820 2816

Europe:

(tel) 31 20 547 2111

Japan:

(tel) (81) 426 56 7832
(fax) (81) 426 56 7840

Korea:

(tel) (080) 769 0800
(fax) (080)769 0900

Latin America:

(tel) (305) 269 7500

Taiwan:

(tel) 0800 047 866
(fax) 0800 286 331

Other Asia Pacific Countries:

(tel) (65) 6375 8100
(fax) (65) 6755 0042
Email: tm_ap@agilent.com

Contacts revised: 1/12/05

Product specifications and descriptions in this document subject to change without notice.

© Agilent Technologies, Inc. 2005
Printed in USA, March 21, 2005
5968-6421EN



Agilent Direct

www.agilent.com/find/agilentdirect
Quickly choose and use your test equipment solutions with confidence.



Agilent Technologies