



Leakage Current Tester TOS3200



Conforms to international standard IEC 60990
("Methods of measurement of touch current and protective conductor current").

Current measurement range: DC/RMS: 30 μ A to 30 mA, PEAK: 50 μ A to 90 mA

Seven built-in measurement circuit networks conforming to IEC 60990 and other standards.

GPIB, RS-232C, and USB interfaces equipped as standard.



**Conforms to safety standards for general electrical equipment.
Supports all touch current and protective conductor current
(earth leakage current) tests.**

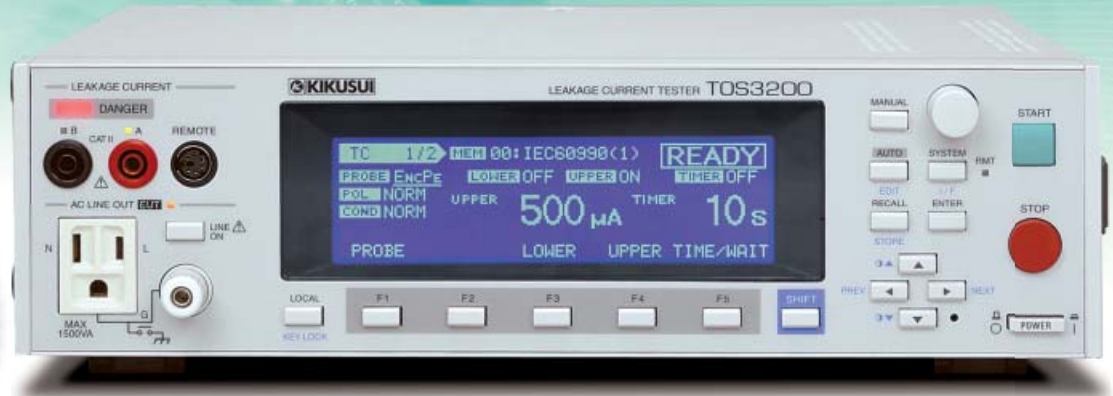

**A leakage current tester has now been added to the TOS Series...
Conforms to international standard IEC 60990 (“Methods of
measurement of touch current and protective conductor current”).**

Leakage Current Tester

TOS3200

The Leakage Current Tester TOS3200 is designed to perform leakage current (touch current and protective conductor current) tests on general electrical equipment but not medical electrical equipment. It enables you to conduct tests that conform to the requirements of the applicable IEC, UL, JIS, and other standards, as well as the Electrical Appliance and Material Safety Law. The memory in the main unit stores the 51 types of test conditions laid down in the IEC/JIS standards for information technology equipment, household electrical appliances, audio, video electronic apparatus, luminaires, motor-operated electric tools, and electrical equipment for measurement and control and in the Electrical Appliance and Material Safety Law, thereby enabling you to conduct standard tests with simple panel operation.

● Capable of measuring leakage current in three modes

Touch current (TC) operating mode*

Enables you to measure the touch current flowing between the enclosure (accessible portion) of the electrical equipment under test (EUT) and the power line incorporating the earth wire, via a human phantom circuit. For human phantom circuits, seven measurement circuit networks (NTWKs) conforming to the applicable standards are provided as standard. The switching of the polarities of the power line to the EUT, as well as single-fault conditions, are automatically set with relays inside the tester.

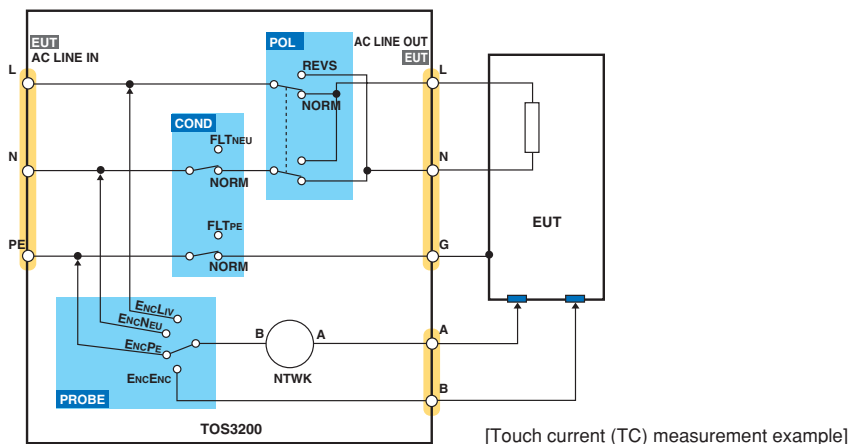

Protective conductor current (PCC) operating mode*

Enables you to measure the current flowing through the protective conductor (earth wire) by connecting the power plug (NEMA5-15 or an equivalent) of an item of 100 V electrical equipment to the socket on the front panel. A multi-outlet is available as an option (sold separately) to accommodate the different plugs used around the world.

Meter (METER) operating mode

In the same way as an ordinary multimeter, enables you to measure voltage and current using measurement terminals A and B on the front panel. For voltage measurement, it offers a “safety extra low voltage” (SELV) detection function; for current measurement, it offers a measurement function using measurement circuit networks (NTWKs).

* TC=Touch Current
PCC=Protective Conductor Current

● Seven built-in measurement circuit networks

It offers built-in seven measurement circuit networks (NTWKs) for measuring the touch current of general electrical equipment.

● Measurement circuit network (network A)

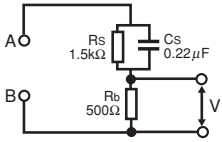

● Measurement circuit network (network B)

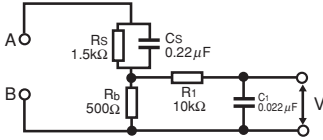

● Measurement circuit network (network C)

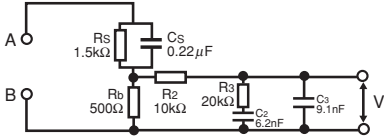

● Measurement circuit network (network D)

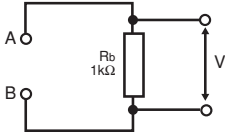

● Measurement circuit network (network E)

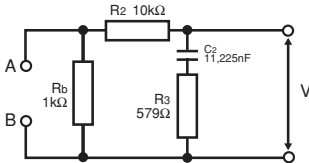

● Measurement circuit network (network F)

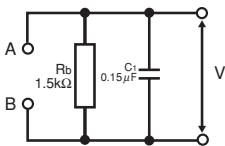

● Measurement circuit network (network G)

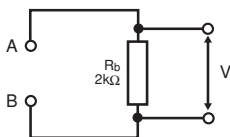

● Rear panel



● Up to 30 mA for RMS measurement

Capable of measuring 30 μ A to 30 mA for DC/RMS measurement and 50 μ A to 90 mA for PEAK measurement, both in three ranges. Two range switching functions are provided, namely, a fixed range function (FIX) and auto range function (AUTO), which conform to the current to be measured.

For RMS measurement, the “true root-mean-square value” is achieved.

● Easy-to-understand operation

Simple operation is possible thanks to the intuitively understandable test condition menu and the function keys/rotary knobs.

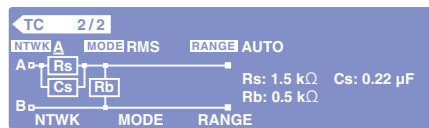
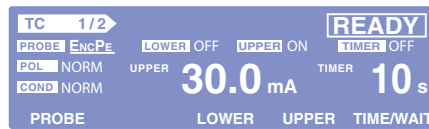

[Setting screen for touch current (TC) measurement]

● Enables the continuous execution of tests

Allows you to automatically conduct TC and PCC tests as a single sequence program by setting their test conditions as up to 100 independent tests (steps). You can set up to 100 sequence programs, with up to 500 steps in total.

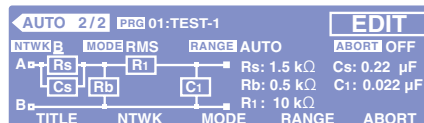

[Setting screen for auto tests]

● Capable of saving test results

For independent tests, enables you to save not only test results but also the test date and time and the test conditions for up to 50 tests; for auto tests, you can save this data for up to 50 programs. You can also save the test results as external records using the USB and other interfaces.

● 51 types of standard test conditions are preset

The memory in the main unit is pre-written with 51 types of test conditions for general electrical equipment, which conform to IEC 60990 and the standards listed below. You can set the standard test conditions merely by calling them.

[Standards covered by the memory]

Standard No.	Applicable electrical equipment
IEC60950	Information technology equipment
IEC60335	Household and similar electrical appliances
IEC60065	Audio, video and similar electronic apparatus
IEC60745	Hand-held motor-operated electric tools
IEC60598	Luminaires
IEC61010	Electrical equipment for measurement, control, and laboratory use
Electrical Appliance and Material Safety Law	Electrical appliances
IEC61029	Transportable motor-operated electric tools

● Lets you manage the calibration time limit

You can set a calibration time limit in the tester, such that when this time limit is exceeded, a warning message appears or the use of the tester is restricted. This is a new feature whereby the tester itself conducts calibration management.

● USB interface provided as standard

In addition to the SIGNAL I/O, GPIB, and RS-232C interfaces, a USB interface is also provided as standard.

● Range of other functions

- “MAX function,” which retains the largest current measured.
- “CONV function,” which converts the measured current value into the corresponding value for the preset power voltage.
- “SELV function,” which causes the DANGER lamp to turn ON if a preset safety extra low voltage (SELV) is exceeded in meter measurement mode.
- “CHECK function,” which performs self-analysis of the measurement circuit networks.

● Options



Multi-outlet [OT01-TOS]



Test probe [HP21-TOS]

Specifications

Measurement item, measurement mode		
Measurement item	3 types, namely, touch current (TC) measurement, protective conductor current (PCC) measurement, and METER	
Measurement method	TC Measure the voltage drop across the reference resistor, using a measurement circuit network (NTWK), and then calculate the current.	
	PCC Measure the voltage drop across the reference resistor connected to the protective earth wire, and then calculate the current.	
	METER Measure the voltage and current using the measurement terminals.	
Measurement mode	DC/RMS/PEAK (RMS being the true root-mean-square value)	
Measurement circuit network (NTWK)	Network A Basic measurement element: (1.5 kΩ/0.22 μF) + 500 Ω (conforming to IEC 60990)	
	Network B Basic measurement element: (1.5 kΩ/0.22 μF) + 500 Ω/(10 kΩ + 0.022 μF) (conforming to IEC 60990)	
	Network C Basic measurement element: (1.5 kΩ/0.22 μF) + 500 Ω/(10 kΩ + (20 kΩ + 6.2 nF)/9.1 nF) (conforming to IEC 60990)	
	Network D Basic measurement element: 1 kΩ (Electrical Appliance and Material Safety Law, etc.)	
	Network E Basic measurement element: 1 kΩ/(10 kΩ + 11.225 nF + 579 Ω) (conforming to the Electrical Appliance and Material Safety Law)	
	Network F Basic measurement element: 1.5 kΩ/0.15 μF (UL, etc.)	
	Network G Basic measurement element: 2 kΩ (general purpose)	
Network constant tolerance	Resistance: ±0.1%, capacitor 0.15 μF: ±2%, other: ±1%	
Current measurement section		
Measurement range	Range 1 DC/RMS: 30 μA to 600 μA, PEAK: 50 μA to 850 μA (*3)	
	Range 2 DC/RMS: 125 μA to 6.00 mA, PEAK: 175 μA to 8.50 mA (*3)	
	Range 3 DC/RMS: 1.25 mA to 30.0 mA, PEAK: 1.75 mA to 90.0 mA (*3)	
Range switching	AUTO/FIX	
Measured current (i) display resolution	i < 1 mA: □□□□ μA/1 μA, 1 mA ≤ i < 10 mA: □□□ mA/0.01 mA 10 mA ≤ i < 100 mA: □□□ mA/0.1 mA	
Measurement accuracy (*5)	Range 1	DC ±(5.0% of rdng + 20 μA)
		RMS 15 Hz ≤ f ≤ 10 kHz: ±(2.0% of rdng + 8 μA) 10 kHz < f ≤ 1 MHz: ±(5.0% of rdng + 10 μA)
		PEAK 15 Hz ≤ f ≤ 10 kHz: ±(5.0% of rdng + 10 μA)
	Range 2	DC ±(5.0% of rdng + 50 μA)
		RMS 15 Hz ≤ f ≤ 10 kHz: ±(2.0% of rdng + 20 μA) 10 kHz < f ≤ 1 MHz: ±(5.0% of rdng + 20 μA)
		PEAK 15 Hz ≤ f ≤ 1 kHz: ±(2.0% of rdng + 50 μA) 1 kHz < f ≤ 10 kHz: ±(5.0% of rdng + 50 μA)
	Range 3	DC ±(5.0% of rdng + 0.5 mA)
		RMS 15 Hz ≤ f ≤ 10 kHz: ±(2.0% of rdng + 0.2 mA) 10 kHz < f ≤ 1 MHz: ±(5.0% of rdng + 0.2 mA)
		PEAK 15 Hz ≤ f ≤ 1 kHz: ±(2.0% of rdng + 0.5 mA) 1 kHz < f ≤ 10 kHz: ±(5.0% of rdng + 0.5 mA)
Input resistance, input capacitance	1 MΩ±1%, < 200 pF	
Common mode rejection ratio	f ≤ 10 kHz: 60 dB or greater, 10 kHz < f ≤ 1 MHz: 40 dB or greater	
Judgement function		
Judgement method	Pass/fail judgement by setting upper and lower current limits in window comparator mode	
Judgement	U-FAIL for currents above the upper limit; L-FAIL for currents below the lower limit.	
Display, etc.	U-FAIL/L-FAIL/PASS display, buzzer sounding	
PASS hold	The time for which a PASS judgement is retained can be set to 0.2 s to 10.0 s or to HOLD.	
Setting range	Range 1 DC/RMS: 30 μA to 600 μA, PEAK: 50 μA to 850 μA (*4)	
	Range 2 DC/RMS: 151 μA to 6.00 mA, PEAK: 213 μA to 8.50 mA (*4)	
	Range 3 DC/RMS: 1.51 mA to 30.0 mA, PEAK: 2.13 mA to 90.0 mA (*4)	
Judgement accuracy	Conforms to measurement accuracy. (Read rdng as set.)	
Measurement of voltage between A and B		
Measurement range	DC/RMS: 10.000 V to 300.0 V, PEAK: 15.000 V to 430.0 V	
Accuracy	±(3% of rdng + 2V), measurement range fixed at AUTO.	
Input impedance	Approx. 40 MΩ	
SELV detection	Set the SELV to detect; if this value is exceeded, the DANGER lamp is turned ON.	
SELV setting range	10 V to 99 V, in 1-V steps, OFF function provided.	
Timer, test execution function, memory		
Timer	Test wait time Setting range: 0 s to 999 s, accuracy: ±(100 ppm of set + 20 ms)	
	Test time Setting range: 1 s to 999 s/OFF function, accuracy: ±(100 ppm of set + 20 ms)	
Text execution	Auto test (AUTO): Automatic execution of up to 100 steps (test conditions) Independent test (MANUAL): Independent execution of TC, PCC, or METER measurement	
Memory	Test conditions AUTO: Up to 100 sequence programs can be saved (up to 500 steps in total). MANUAL: Up to 100 sequence programs can be saved.	
	Test results The user can select whether to save the judgement results when they are output at the end of the tests. AUTO: Test results for up to 50 programs can be recorded. MANUAL: Test results for up to 50 tests can be recorded.	

- * The warm-up time must be 30 minutes or longer.
- * rdng denotes a reading, set denotes the set value, and EUT is the electrical equipment under test.

- *1. May not apply to custom-made or modified products.
- *2. Limited to products with CE marking on their panels.
- *3. The maximum range is indicated. The range differs depending on the measurement circuit network.
- *4. The maximum range is indicated. The range differs depending on the measurement circuit network. Also, the UPPER setting in each range when the FIX range is selected is indicated.
- *5. Current converted value in Network A,B,C and PCC measurement, based on built-in voltmeter accuracy.

Other functions	
Measured value conversion (CONV)	Converts the measured current value into the corresponding value at the preset power voltage. Setting range: 80.0 V to 300.0 V, OFF function provided.
MEASURE MODE	Selects a measured value from those below.
	NORM: Displays the measured value in the measurement period.
	MAX: Displays the largest measured value in the measurement period.
Power positive/negative phase selection (POL)	NORM: Positive phase connection, REVS: Negative phase connection
Single fault selection (COND)	NORM: Normal, FLTNEU: Disconnection of the neutral wire, FLTPE: Disconnection of the protective earth wire
Earth check	Generates CONTACTFAIL if the enclosure is grounded in a TC (EnclLiv, EncNeu) test.
MEASURE CHECK	Checks the measurement function between measurement terminals A and B, and places the tester in the PROTECTION state if an error is detected.
Voltage measurement(EUT)	Measurement range: 80.0 V to 250.0 V, resolution: 0.1 V, accuracy: ±(3% of rdng + 1 V)
Current measurement(EUT)	Measurement range: 0.1 A to 15.00 A, resolution: 0.01 A, accuracy: ±(5% of rdng + 30 mA)
Power measurement (effective power)	Measurement range: 10 W to 1500 W
	Accuracy (at a power voltage of 80 V or higher and a load power factor of 1): ±(5% of rdng + 8 W)
System clock	Recording Items: Calibration date and time, test date and time, permissible date and time: Up to 2099
	Calibration time limit management (CAL PROTECT) ON: Places the tester in the PROTECTION state (disables the use of the tester), OFF: Displays warning.
Protective operation	Relay operation error, overload, over range, measurement function check, failure of internal battery, etc.
Interface	
RS-232C	D-Sub 9-pin connector (conforming to EIA-232D), baud rate: 9600/19200/38400 bps (For connection to a PC, use a "9-pin female-female reverse" cable.)
GPIB	Conforms to IEEE Std. 488-1978. (SH1,AH1,T6,TE0,L4,LE0,SR1,PP0,DC1,DT0,C0,E1)
USB	USB Specification 2.0
REMOTE	6-pin MINIDIN connector (for HP21-TOS (separately sold option) only)
SIGNAL I/O	25-pin D-Sub connector
General	
Measurement terminals	Rated voltage/current Terminals A to B: 250 V, terminal to chassis: 250 V, 100 mA
	Measurement category CAT II
Environment	Effective terminal display Terminals effective to measurement are indicated with LED lamps.
	Specification assured range Temperature: 5°C to 35°C, humidity: 20% rh to 80% rh (no condensation)
	Operating range Temperature: 0°C to 40°C, humidity: 20% rh to 80% rh (no condensation)
	Storage range Temperature: -20°C to 70°C, humidity: 90% rh or less (no condensation)
Power	Mounting location Indoors, altitude of 2000 m or less
	Input power Nominal input rating: 100Vac to 240Vac, 50/60Hz, power consumption: 70 VA max. Rated output capacity: 1500 VA, maximum current: 15 A, rush current: 70 A peak max. (within 20 ms)
Insulation resistance	30 MΩ or greater (500 Vdc) (between AC line and chassis, between measurement terminal and chassis)
Withstand voltage	1390 Vac, 2 seconds/20 mA or less (between AC line and chassis)
Earth continuity	25 Aac/0.1 Ω or less
Safety (*1)	Conforms to the requirements of the directive and standard below. Low Voltage Directive 73/23/ECC, EN61010-1 (Class I, Pollution degree 2)
	Conforms to the requirements of the directive and standard below. EMC Directive 89/336/ECC, EN61326, EN61000-3-2, EN61000-3-3
Electromagnetic compatibility (*1, *2)	Applicable conditions: All cables and wires used to connect to this product must be shorter than 3 meters. Use the supplied test leads.
Outside dimensions, weight	320 (345) W × 88 (105) H × 270 (330) D mm, approx. 5 kg
Accessories	1 set of test leads (TL21-TOS: red and black, one each, with alligator clips) 1 flat probe (FP01-TOS), 1 spare fuse (15A, for EUT power) 1 instruction manual, 1 circuit principle diagram sticker 2 power cords (for the tester and for the EUT AC line)

(External dimensional drawings)

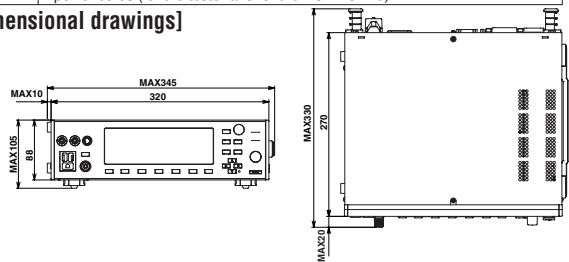

Options	
Product name/ model name	Test lead TL21-TOS (equivalent to the supplied lead)
	Flat probe FP01-TOS (equivalent to the supplied probe)
	Test probe HP21-TOS (with a start switch)
	Multi-output OT01-TOS (allows the connection of the different plugs used around the world)
	Rack mount bracket KRA3-TOS (inch type)
	Rack mount bracket KRA150-TOS (millimeter type)

■Distributor:



KIKUSUI ELECTRONICS CORPORATION

1-1-3, Higashiyamata, Tsuzuki-ku, Yokohama, 224-0023, Japan
Phone: (+81) 45-593-7570, Facsimile: (+81) 45-593-7571, www.kikusui.co.jp

●Affiliate companies:



KIKUSUI AMERICA, INC.

1744 Rollins Road, Burlingame, CA 94010
Phone: (650) 259-5900, Facsimile: (650) 259-5904
Toll Free: (1-800-KIKUSUI), www.kikusui.us



KIKUSUI TRADING (SHANGHAI) Co., Ltd.

Room D, 11F, Yonghua Bldg., No.138, Pudong Road,
Pudong New District, Shanghai City
Phone: 021-5887-9067, Facsimile: 021-5887-9069, www.kikusui.cn

For our local sales distributors and representatives, please refer to "sales network" of our website.

Printed in Japan

■ All products contained in this catalogue are equipment and devices that are premised on use under the supervision of qualified personnel, and are not designed or produced for home-use or use by general consumers. ■ Specifications, design and so forth are subject to change without prior notice to improve the quality. ■ Product names and prices are subject to change and production may be discontinued when necessary. ■ Product names, company names and brand names contained in this catalogue represent the respective registered trade name or trade mark. ■ Colors, textures and so forth of photographs shown in this catalogue may differ from actual products due to a limited fidelity in printing. ■ Although every effort has been made to provide the information as accurate as possible for this catalogue, certain details have unavoidably been omitted due to limitations in space. ■ If you find any misprints or errors in this catalogue, it would be appreciated if you would inform us. ■ Please contact our distributors to confirm specifications, price, accessories or anything that may be unclear when placing an order or concluding a purchasing agreement.

Issue:Mar.2007 2007031KEMSEC21