

# Frequency Counters

SR620 — Universal time interval and frequency counter



## SR620 Time Interval/Frequency Counter

- **25 ps single-shot time resolution**
- **1.3 GHz frequency range**
- **11-digit frequency resolution (1 s)**
- **0.001° phase resolution**
- **Statistical analysis & Allan variance**
- **Graphical output to X-Y scopes**
- **Hardcopy to printers and plotters**
- **GPIB and RS-232 interfaces**
- **Optional ovenized timebase**

• **SR620 ... \$4950 (U.S. list)**

The SR620 Time Interval Counter performs virtually all the time and frequency measurements required in a laboratory or ATE environment. The instrument's high single-shot timing resolution, low jitter and outstanding flexibility make it the counter of choice for almost any application.

### SR620 Measurements

The SR620 measures time interval, frequency, pulse-width, rise and fall time, period, phase and events. Time intervals are measured with 25 ps rms resolution, making the SR620 one of the highest resolution counters available. Frequency is measured from 0.001 Hz to 1.3 GHz, and a choice of gates ranging from 1 period to 500 seconds is provided. The SR620 delivers up to 11 digits of frequency resolution in one second, making it suitable for measurement applications ranging from short-term phase locked loop jitter, to the long-term drift of atomic clocks. All measurement modes are supported by a wide variety of flexible arming and triggering options.

### Histograms and Strip Charts

Unlike conventional counters that only have numeric displays, the SR620 provides live, graphical displays of measurement results. Graphical output of measurement data is available in three formats: a histogram showing the distribution of values within a set of measurements, a strip chart of mean values from successive measurements, or a strip chart of jitter (standard deviation or Allan variance) values from successive

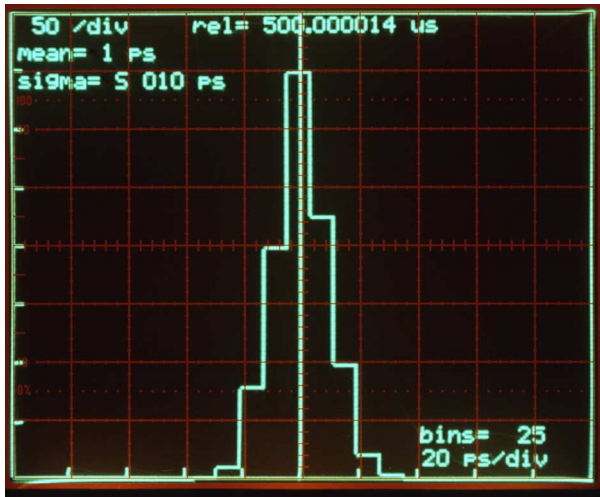

*Histogram display*

measurements. Up to 250 strip chart points or histogram bins can be displayed.

Both histograms and strip charts can be displayed on any oscilloscope with an X-axis input (see pictures), or can be plotted on an HP-GL compatible plotter or dot-matrix printer. Convenient cursors allow you to read the value of any data point in the histogram or strip chart. Autoscale and zoom features make it simple to display all, or any portion, of the graphs.

### Complete Statistical Calculations

The SR620 can make measurements on a single-shot basis or calculate the statistics of a set of measurements. Sample sizes from one to one million can be selected. The SR620 will automatically calculate the mean, standard deviation or Allan variance, minimum and maximum for each set of measurements.

### Reference Output

A precision, 1 kHz, 50 % duty cycle square wave is available at the front-panel REF output. The REF output can be used as a source of start or stop pulses for any of the SR620's measurement modes. For instance, the length of a cable connected between REF and the B input can be precisely determined by measuring the time delay between REF and B.

### Built-In DVMs and Analog Outputs

Two rear-panel DVM inputs make measurements of DC voltages with 0.3 % accuracy ( $\pm 20$  VDC range). These values



*SR620 rear panel*

may be read via the interfaces or displayed directly on the front panel.

Two DAC outputs continuously provide voltages proportional to the mean and the jitter of the measurement sample. These 0 to 10 V outputs can drive strip chart recorders or can be set to provide fixed or scanned output voltages.

### Built-In Auto-Calibration

A sophisticated, built-in auto-calibration routine nulls insertion delays between start and stop channels and compensates for the differential nonlinearities inherent in analog time-measurement circuitry. The auto-calibration routine takes about two minutes to perform and should be run every 1000 hours of operation.

### 10 MHz Reference

The choice of timebase affects both the resolution and accuracy of measurements made with the SR620. SRS offers a standard timebase with an aging coefficient of  $1 \times 10^{-6}$ /year, or an optional ovenized-oscillator timebase with only  $5 \times 10^{-10}$ /day aging and about an order of magnitude better short-term stability than the standard timebase. A rear-panel input lets you connect any external 5 MHz or 10 MHz source as a timebase.

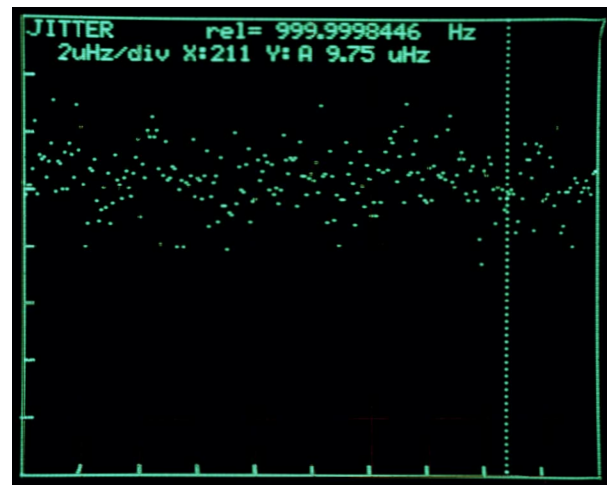

*Allan variance plot*

### Computer Interfaces

Standard GPIB (IEEE-488.2) and RS-232 interfaces allow remote control of the SR620. All instrument functions and configuration menu settings are accessible via the interfaces. A fast binary dump mode outputs up to 1400 measurements per second to a computer. A parallel printer port allows direct printing from the instrument. Standard IEEE-488.2 communications are supported, and plotter outputs are provided in HP-GL format making interfacing simple and easy. For debugging, the last 256 characters transmitted over the interfaces can be viewed on the front panel.

**Timebase**

	<i>Standard</i>	<i>Option 01</i>
Frequency	10.000 MHz	10.000 MHz
Type	TCVCXO	Ovenized VCXO
Aging	$1 \times 10^{-6}$ /yr.	$5 \times 10^{-10}$ /day
Allan variance (1 s)	$3 \times 10^{-10}$ (typ.)	$<1 \times 10^{-11}$
Stability (0 to 50 °C)	1 ppm	$<2 \times 10^{-9}$
Settability	0.01 ppm	0.001 ppm

External timebase User may supply 5 or 10 MHz timebase (1 V nominal)

**Time Interval, Width, Rise and Fall Times**

Range	-1000 to +1000 s in +/-TIME mode -1 ns to +1000 s in all others modes
Trigger rate	0 to 100 MHz
Display LSD	4 ps single sample, 1 ps with avg.
Resolution	
Standard timebase	$((25 \text{ ps typ. } [50 \text{ ps max.}]^2 + (0.2 \text{ ppb} \times \text{Interval})^2) / N)^{1/2} \text{ rms}$
Option 01	$((25 \text{ ps typ. } [50 \text{ ps max.}]^2 + (0.05 \text{ ppb} \times \text{Interval})^2) / N)^{1/2} \text{ rms,}$ (N = sample size)
Error	$<\pm(500 \text{ ps typ. } [1 \text{ ns max.}] + \text{Timebase Error} \times \text{Interval} + \text{Trigger Error})$
Relative error	$<\pm(50 \text{ ps typ. } [100 \text{ ps max.}] + \text{Timebase Error} \times \text{Interval})$
Arming modes	+TIME (Stop is armed by Start) +TIME EXT (Ext arms Start) +TIME EXT HOFF (Leading EXT edge arms Start, trailing EXT edge arms Stop) $\pm$ TIME (Armed by Start/Stop pair), $\pm$ TIME CMPL (Armed by Stop/Start pair) $\pm$ TIME EXT (Armed by EXT input edge) EXT arming may be internally delayed or scanned with respect to the EXT input in variable steps. The step size may be set in a 1-2-5 sequence from 1 $\mu$ s to 10 ms. The maximum delay is 50,000 steps.
Display	16-digit fixed point with 1 ps LSD
Sample rate	$N \times (800 \mu\text{s} + \text{measured time interval}) + \text{calculation time}$ (N=sample size) The calculation time occurs only after N measurements are completed and varies from zero (N=1, no graphics, binary) to 5 ms (N=1, no graphics) to 10 ms (display mean or standard dev.) to 60 ms (histogram).

**Frequency**

Range	0.001 Hz to 300 MHz via comparator inputs. 40 MHz to 1.3 GHz via internal UHF prescalers.
-------	---

Error	RATIO A/B range: $10^{-9}$ to $10^3$ $<\pm((100 \text{ ps typ. } [350 \text{ ps max.}]) / \text{Gate} + \text{Timebase Error}) \times \text{Frequency}$
Gates	External, 1 period, 1 $\mu$ s to 500 s in 1-2-5 sequence. Gates may be externally triggered with no delay. Gates may be delayed relative to an EXT trigger. The delay from trigger is set from 1 to 50,000 gate widths.
Display	16-digit fixed point with LSD = Freq. $\times$ 4 ps/Gate. 1 $\mu$ Hz maximum resolution (1 nHz with $\times$ 1000 for frequencies $<1$ MHz)

**Period**

Range	0 to 1000 s
Error	RATIO A/B range: $10^{-9}$ to $10^3$ $<\pm((100 \text{ ps typ. } [350 \text{ ps max.}]) / \text{Gate} + \text{Timebase Error}) \times \text{Period}$
Gates	Same as frequency
Display	16-digit fixed point, LSD = 1 ps (1 fs with $\times$ 1000 for periods $<1$ s)

**Phase**

Definition	Phase = $360 \times (T_b - T_a) / \text{Period A}$
Range	-180 to +180 degrees, 0 to 100 MHz
Resolution	$(25 \text{ ps} \times \text{Freq.} \times 360 + 0.001)^\circ$
Gate	0.01 seconds (1 period min.) for period measurement and 1 sample for time interval measurement. Period may also be measured using externally triggered internal gates as in frequency mode.
Error	$<\pm(1 \text{ ns} \times \text{Freq.} \times 360 + 0.001)^\circ$

**Counts**

Range	$10^{12}$ , RATIO A/B range: $10^{-9}$ to $10^3$
Count rate	0 to 300 MHz
Gates	Same as frequency
Display	12 digits

**Inputs**

Bandwidth	300 MHz (1.2 ns rise time)
Threshold	-5.00 to +5.00 VDC (10 mV resolution)
Accuracy	15 mV + 0.5 % of setting
Sensitivity	see graph next page
Auto level	Threshold set between peak input excursions. ( $f > 10$ Hz, duty cycle $> 10^{-6}$ )
Slope	Rising or falling edge
Impedance	(1 M $\Omega$ + 30 pF) or 50 $\Omega$ 50 $\Omega$ termination has SWR $< 2.5:1$ from 0 to 1.3 GHz
Coupling	AC or DC (Ext is always DC coupled)
Input noise	350 $\mu$ Vrms (typ.)

Prescaler see graph  
 Protection 100 V, 50 Ω terminator is released if input exceeds ±5 Vp

**REF Output**

Frequency 1.00 kHz (accuracy same as timebase)  
 Rise/fall time 2 ns  
 Amplitude TTL: 0 to 4 V (2 V into 50 Ω)  
 ECL: -1.8 to -0.8 V into 50 Ω

**DVM Inputs**

Full scale ±1.999 or ±19.99 VDC  
 Type Sample & hold with successive approximation converter  
 Impedance 1 MΩ  
 Accuracy 0.3 % of full scale  
 Speed Approximately 5 ms

**D/A Outputs**

Full scale ±10.00 VDC  
 Resolution 5 mV  
 Impedance <1 Ω  
 Default Voltage proportional to mean and deviation  
 Accuracy 0.3 % of full scale

**Graphics**

Scope Two rear-panel outputs to drive x-y analog oscilloscope  
 Displays Histograms and strip charts of mean and jitter  
 X-axis -5 to +5 V for 10 division deflection  
 Y-axis -4 to +4 V for 8 division deflection  
 Resolution 250 (H) × 200 (V) pixels  
 Hardcopy Centronics port for dot-matrix printers. RS-232, IEEE-488.2 for HP-GL compatible plotters.

**Interfaces**

RS-232 300 to 19.2 kbaud. All instrument functions may be controlled.  
 GPIB IEEE-488.2 interface. All instrument functions may be controlled.  
 Speed Approximately 150 ASCII formatted responses per second.  
 1400 binary responses per second.

**General**

Operating 0 °C to 50 °C  
 Power 70 W, 100/120/220/240 VAC, 50/60 Hz  
 Dimensions 14" × 3.5" × 14" (WHD)  
 Weight 11 lbs.  
 Warranty One year parts and labor on defects in materials and workmanship

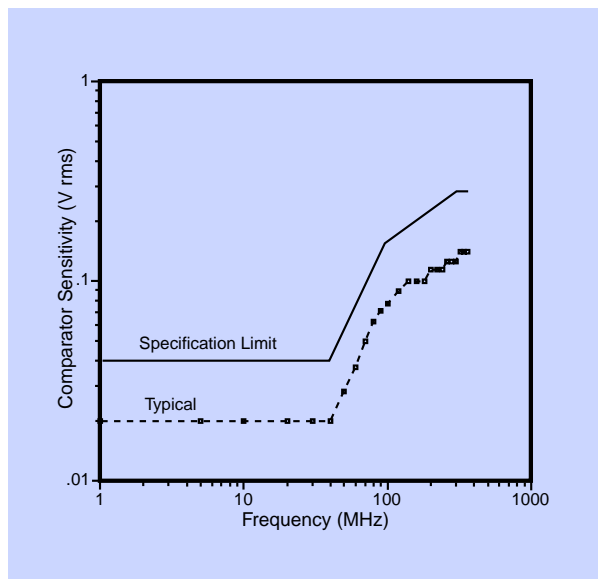

*Input sensitivity*

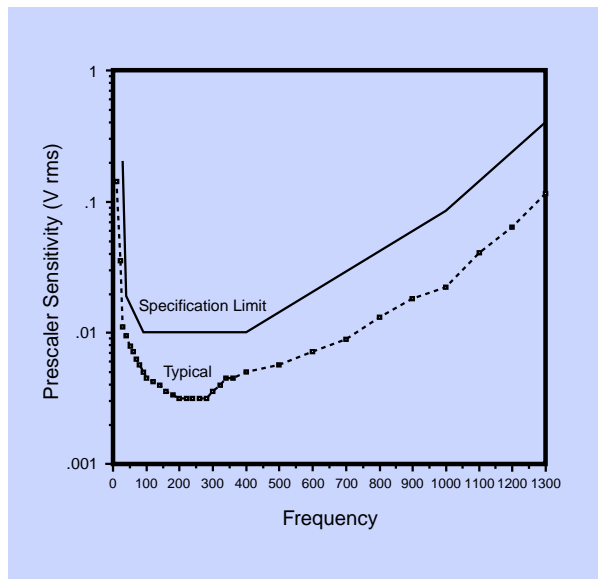

*Prescaler sensitivity*

**Ordering Information**

SR620	Time interval/frequency counter (with rack mount kit)	\$4950
Option 01	2 ppb OCXO timebase	\$950

**SR620 Measurement Modes**

**Time**

In its most basic measurement mode, the SR620 measures the time interval between a start and a stop pulse. Either of the SR620's two inputs, or its REF output, may be selected as the source of start and stop pulses. Internal and external gating signals can be used to holdoff the acceptance of either start or stop pulses. The SR620 can make both positive time measurements (in which the stop pulse follows the start pulse) and negative time measurements (in which the stop pulse occurs before the start pulse).

**Frequency**

The SR620 measures frequency by the reciprocal frequency counting technique. In other words, the instrument measures the time interval for some integer number of input cycles, then computes frequency by dividing the number of cycles by the time interval. Since no fractional cycle measurements are involved (as would be the case if the instrument measured the number of cycles in a fixed time interval), extremely high frequency resolution can be achieved (11 digits in 1 s). The diagram below illustrates this method of computing frequency. Both internal and external gates are supported.

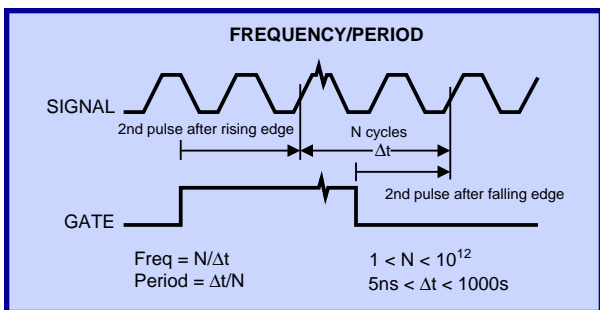

**Pulse Width**

The width of pulses at either input can be measured. Separate start and stop voltages can be selected for pulse width measurements. Resolution and accuracy are the same as time measurement mode.

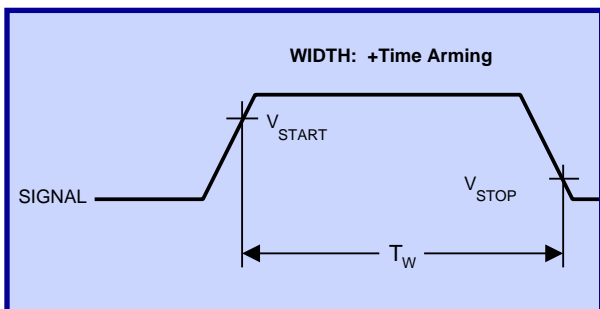

**Transition Time**

Rise and fall times of either input may be measured. Start and stop thresholds may be set between  $\pm 5$  V with 10 mV resolution. The 300 MHz input bandwidth allows measurements of rise and fall times as small as 1 ns.

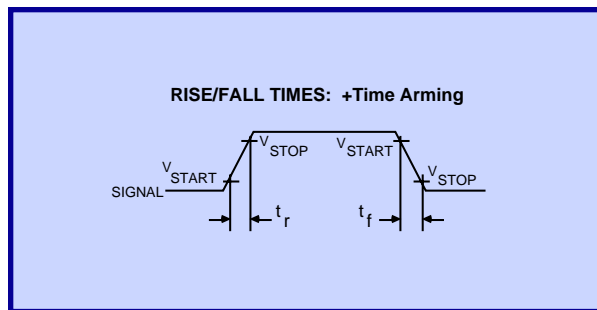

**Period**

The SR620 can also measure the period of waveforms. Period is measured similarly to frequency, but the reciprocal of frequency is computed and displayed.

**Phase**

The phase angle between signals on the A and B inputs can be measured with 0.001 degree resolution. You can measure the phase of signals (at the same frequency) from 0.001 Hz to 100 MHz. The counter actually makes two measurements: a frequency measurement of one channel, and a time measurement of the delay of the second channel with respect to the first. The phase is then computed as shown below.

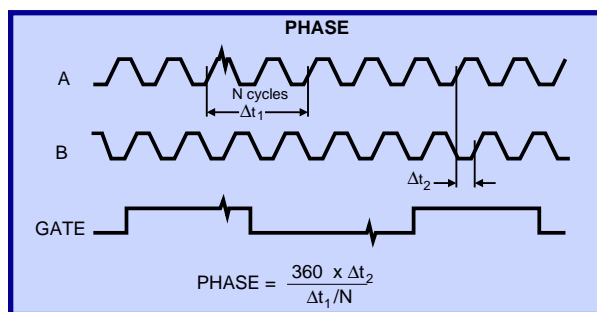

**Event Counting**

The SR620 will also count transitions (events) at either of its inputs. As with all the other modes, event counting may be gated internally or externally, and both the voltage threshold and slope for a transition are adjustable. Event rates up to 300 MHz can be counted with up to 12 digits of resolution. The unit also has a ratio mode which will compute the ratio of the number of events counted on the A and B inputs.