

# 575/578 SOURCE-LOCKING MICROWAVE COUNTERS 10 Hz to 110 GHz

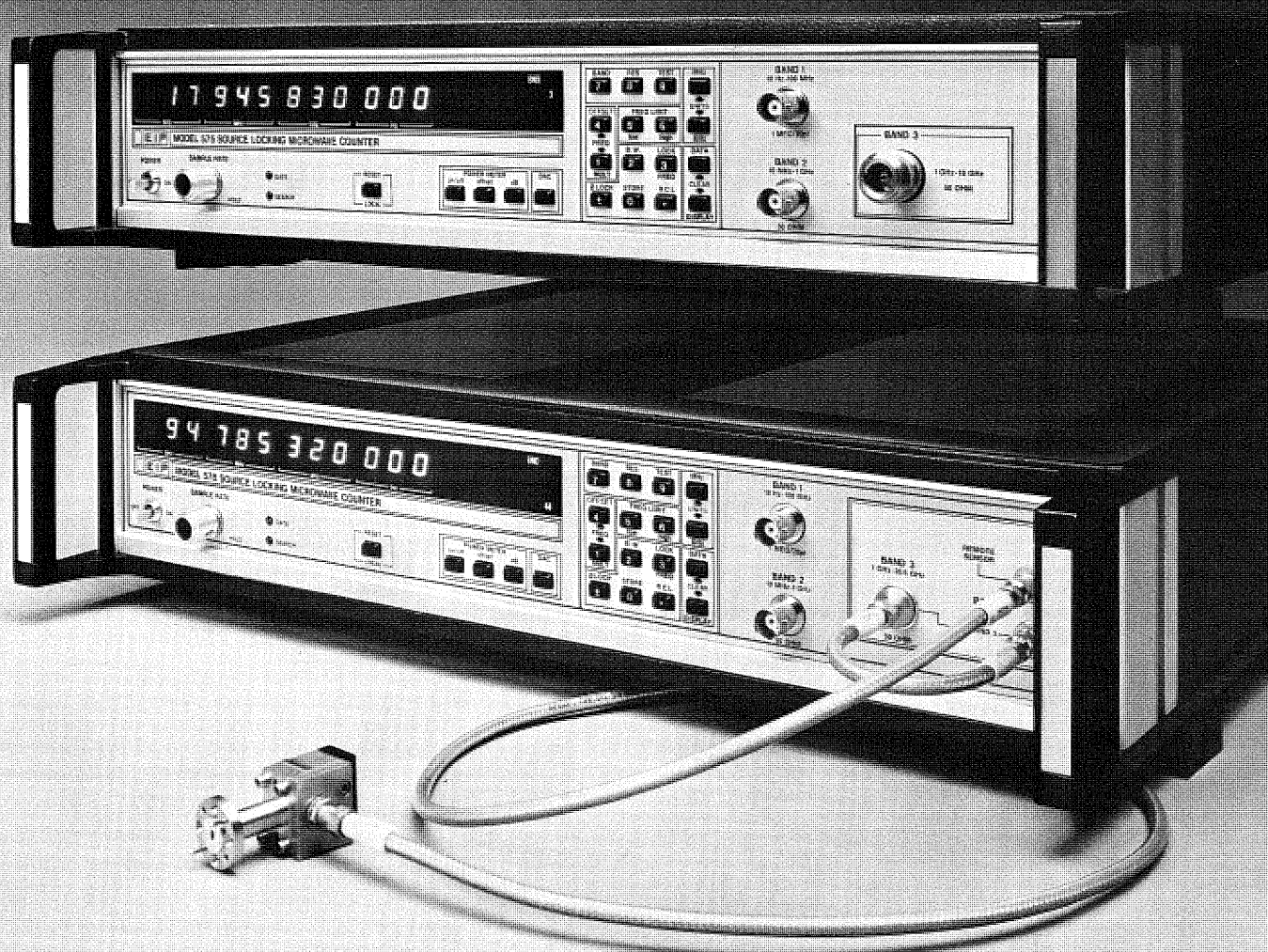

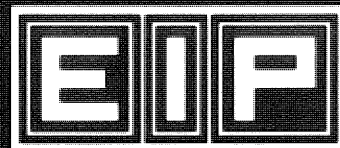

## SEVERAL INSTRUMENTS IN ONE

The Models 575 and 578 Microwave Counters offer an unmatched combination of multiple functions and outstanding performance:

### Source Locking

- Broadband control of swept sources provides synthesizer stability.
- Fully automatic tuning control over the range from 10 MHz to 18 GHz, 26.5 GHz, or 110 GHz (optional) in 10-kHz increments.
- GPIB interface for automatic systems is included as standard equipment.
- Storage and recall of nine programmed frequencies permits instant tuning.

### Frequency Measurement

- Automatic frequency counting over the entire range:  
Model 575 10 Hz to 18 GHz  
Model 578 10 Hz to 26.5 GHz, optionally to 110 GHz

- Superior performance features include:
  - 30 dBm sensitivity
  - 5-watt input protection
  - Multiple-signal discrimination
  - Multiply ( $mx \pm b$ ) function
  - DAC output
  - GPIB operation

### Power Measurement (optional)

- Simultaneous measurement of frequency and power can eliminate the need for a separate power meter.
- Displayed resolution of 0.1 dB provides measurements accurate to  $\pm 0.5$  dB (typical).
- Programmable power offset makes it easy to measure difference from reference or to compensate for external losses.
- Full GPIB control for automatic test system integration.

### Spectrum Analysis

- Unique front-end design combined with frequency-limits function permits frequency and power of individual signals to be measured in a multiple-signal environment.



## AUTOMATIC SOURCE LOCKING

The Models 575 and 578 provide fully automatic control in phase locking virtually any swept signal source to the same accuracy and long-term stability as the time-base oscillator in the counter. This ability to stabilize the frequency of nearly any sweep generator often eliminates the need for an expensive, synthesized signal generator or a single-function, stand-alone "lockbox."

### Wide Frequency Range

Source locking operates in 10-kHz increments, from 10 MHz to the maximum operating range of the counter (18 GHz for the 575, 26.5 GHz for the 578, and 110 GHz for the 578 equipped with the optional frequency-extension package). Over this range, the counter acts as a system controller, exercising broad-band control in phase locking the signal source to the desired frequency.

### Easy Interconnection

As shown in the diagram, only three interconnections are required between the counter and the signal source:

1. Sample of source output.
2. External sweep (coarse tune) input.
3. FM (phase lock) input.

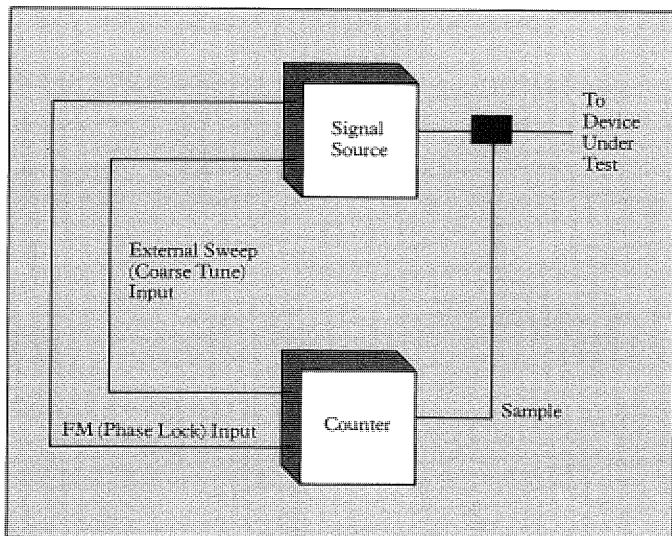

For signal sources which are not equipped with an external sweep input, phase locking is accomplished by using just the FM input. In such a case, the source is tuned manually (or under GPIB control) to within about 100 MHz of the desired frequency. From there, fine tuning and phase locking are automatic.

### Automatic Broad-Band Tuning

Once the source and counter are connected as shown, operation is straightforward and automatic. The operator simply depresses the "lock frequency" key and enters the desired frequency, to 10-kHz resolution, on the keyboard. The "GHz" or "MHz" terminator key completes the data input and activates the counter to lock the signal source to the desired frequency. For example, if the signal source covers

the range from 1 GHz to 18 GHz, and has both external sweep and FM inputs, the counter will automatically lock the source to any frequency within that entire range.

To optimize acquisition time and spectral purity, the counter automatically selects the widest phase-lock loop bandwidth. For the most efficient match with any specific sweeper, a keyboard-controlled override permits the operator to select any of three available bandwidths, 10 kHz, 2 kHz, or 500 Hz.

### Efficient Bus-System Integration

In a GPIB-based system, the 57X Series offers new efficiency in controller programming. First, the signal source need not be equipped for GPIB control; even if the source has GPIB capability, programming steps can be eliminated by letting the counter control the frequency directly over the entire microwave range. Second, a single command to the counter locks the source; since the counter does its own monitoring and correction, the controller need not check the frequency or issue correction commands. The ability to rapidly step and lock the signal source also saves time, as indicated by these representative examples:

Frequency Step	Approximate Lock Time
1 MHz	200 ms
10 MHz	300 ms
1 GHz	500 ms

### Frequency Storage and Recall

For repetitive tests, the operator need not set the desired frequency each time. Up to nine pre-programmed frequencies can be stored for easy recall. This makes the 57X Series counters ideal for such applications as production testing.

### Use With any Source

The 57X Series counters are designed to operate with any source which has an FM input. If the source also includes an external sweep input, the operator need not manually perform even coarse tuning. Although the FM and external sweep input characteristics of various sources may differ, the counter will automatically select the correct polarity and gain constant for the interface.

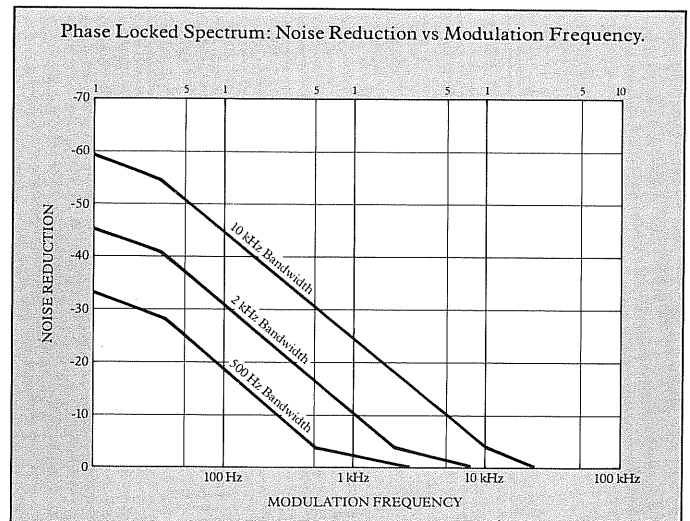

## EXCEPTIONAL FREQUENCY-MEASUREMENT CAPABILITY

As CW frequency counters, the 575 and 578 offer unsurpassed levels of performance and versatility. Outstanding features include 5-watt input protection, 10-dB amplitude discrimination, frequency offsets, multiply ( $mx \pm b$ ) function, and frequency-limit capability.

### Input Protection and Filtering

The 57X Series counters use a YIG-tuned RF input filter which offers several benefits not found in other counters. Among these is exceptional input protection. The filter acts as a highly effective power limiter without decreasing sensitivity. EIP guarantees input protection of a full 5 watts (+37 dBm).

Another benefit of the YIG filter, with its bandwidth of approximately 25 MHz, is its filtering of the RF input. Operating under microprocessor control, its function is similar to that of a tracking pre-selector. This prevents harmonics and other out-of-band spurious signals from interfering with the desired signal. The result is a clean, unambiguous input to the mixer; and the instrument maintains excellent sensitivity.

### Amplitude Discrimination

The counter automatically locks on the strongest RF signal, so long as its level is at least 10 dB higher

than that of the next strongest signal. However, other signals in the spectrum can be selectively measured by using the "frequency limits" feature.

### Frequency Limits

By giving the microprocessor simple instructions from the front panel, the operator can restrict the scan width of the RF filter. Restricting either the upper or lower end of the scan (or both) permits the counter to lock on the strongest signal within the selected frequency range, even though a much stronger signal is present at the input. As shown in the example, the frequency (and optionally, the power) of either signal can be selected and measured accurately.

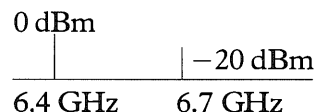

### Frequency Offsets

Front-panel programming permits the selection of either positive or negative frequency offsets to a resolution of 1 Hz. This feature is particularly useful in measuring deviation from a reference signal.

### Multiply ( $mx \pm b$ ) Function

This feature is used in conjunction with frequency offsets. It is particularly useful in applications involv-

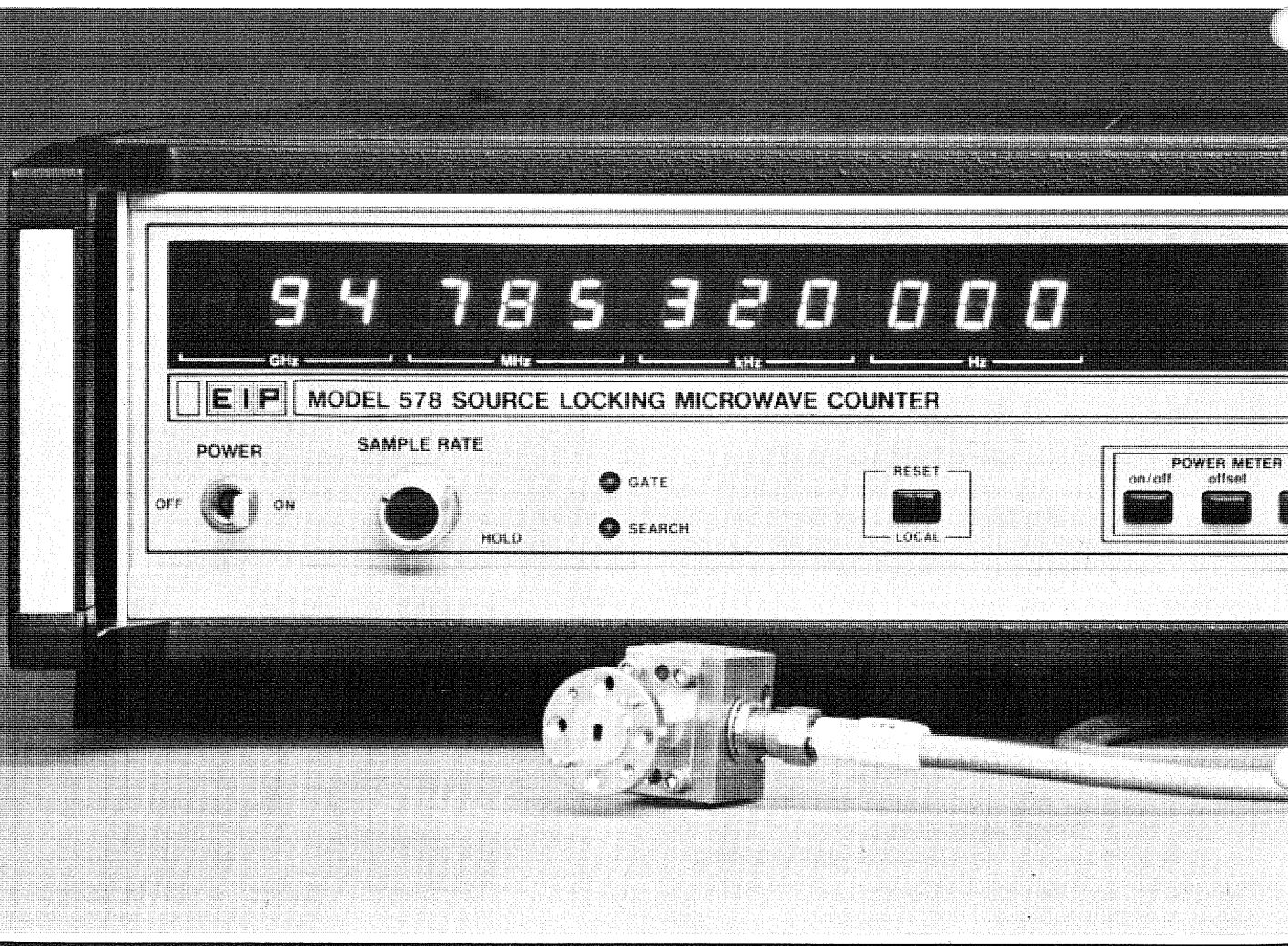

ing low-level receivers and other microwave radio equipment. The measured frequency (from a local oscillator, for example) can be multiplied by any integer from 1 to 99. Then a frequency offset (such as the IF) can be added or subtracted. The resultant,  $y = mx \pm b$ , is displayed to a resolution of 1 kHz.

### Serviceability

Full test and diagnostic routines systematically check the operation of the counter. This makes it possible to troubleshoot the instrument by using its own front-panel display. Moreover, built-in signature analysis helps to isolate faults to a component level. Downtime is minimized through the counter's modular construction, EIP's board-exchange program, and a network of factory-authorized service centers.

## OPTIONS

While most important features are standard on EIP counters, certain options provide even more capability for specific applications.

### Power Measurement

The counter's ability to simultaneously measure frequency and power (except in the source-locking mode) often eliminates the need for a separate instrument. Signal power is measured in dBm, to a resolution of 0.1 dB, from 1 GHz to 18 GHz (model 575) or

26.5 GHz (Model 578). In the power-measurement mode, frequency resolution is 100 kHz. This mode can be used in conjunction with the frequency-limits feature to measure both the frequency and power of an individual signal in a multiple-signal environment. Power offsets, easily entered from the keyboard, can be used to measure power deviation from a reference signal or to compensate for losses in external hook-ups.

### Frequency Extension

For frequencies above 26.5 GHz, the 578 can be equipped with Option 06, an internal module which provides for extending the frequency range to 110 GHz. In addition to Option 06, Model 590 (Frequency Extension Cable Kit) and one or more of the following remote sensors are required:

Option 91	26.5-40 GHz
Option 92	40.0-60 GHz
Option 93	60.0-90 GHz
Option 94	90.0-110 GHz

Option 06 can be installed at the time of original equipment purchase, or it can be retrofitted later by the factory. This extended-frequency capability allows the user to build onto the basic 578 as frequency-measuring requirements change.

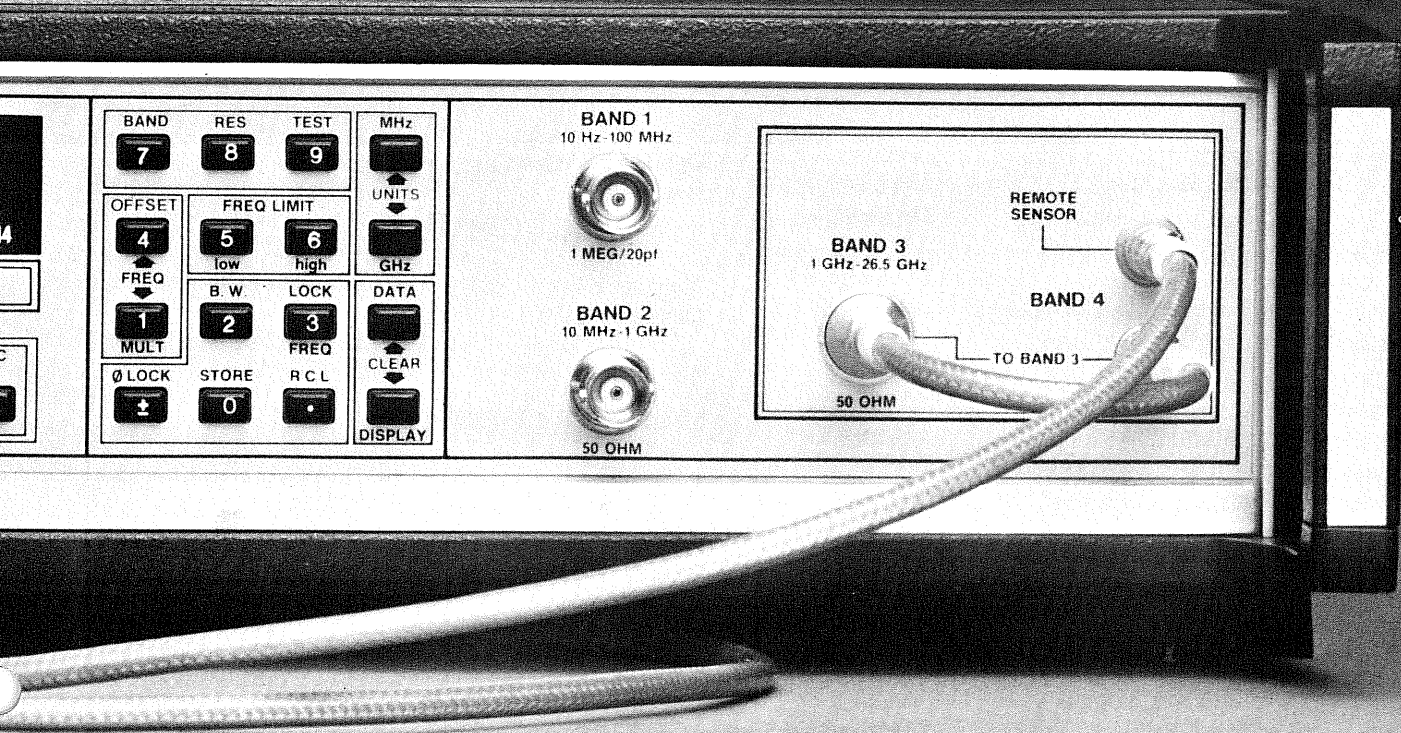

# SPECIFICATIONS

	BAND 1	BAND 2
Range	10 Hz-100 MHz	10 MHz-1 GHz
Sensitivity	25mV rms	-20 dBm
Impedance	1 M $\Omega$ /20 pF	50 $\Omega$
Connector	BNC (female)	BNC (female)
Coupling	AC	AC
Maximum Operating Level	120V rms*	+10 dBm
Damage Level	150V rms*	+27 dBm
Acquisition Time	—	<50 msec

\*(above 1 kHz maximum input decreases @6 dB/octave down to 3.0V rms.)

## BAND 3

Range	1 GHz-18 GHz (Model 575) 1 GHz-26.5 GHz (Model 578)
Sensitivity	-30 dBm: 1 GHz-12.4 GHz -25 dBm: 12.4 GHz-18 GHz -20 dBm: 18 GHz-22 GHz -15 dBm: 22 GHz-26.5 GHz
Impedance	50 $\Omega$
Connector	Precision Type N (female) Model 575, APC-3.5 (female) Model 578
Coupling	AC
Maximum Operating Level	+7 dBm
Damage Level	+37 dBm (5 watts)
Acquisition Time	<250 msec
Automatic Amplitude Discrimination	10 dB
FM Tolerance	20 MHz P-P up to 10 MHz rate
VSWR	2.5:1 Typical
Frequency Limit	Keyboard controlled. Counter will measure largest signal within programmed limits. Signal outside desired range must be separated by 200 MHz (typical) from either limit.
Overload Indication	Display indicates "OVERLOAD" when input level exceeds approximately +10 dBm.

## BAND 4

(Options 91 to 94 used with Model 578/06 and Model 590)

	Option 91	Option 92
578 Band Select	41	42
Waveguide Band	Ka	U
Range	26.5-40 GHz	40-60 GHz
Sensitivity (typical)	-25 dBm	-25 dBm
Waveguide Size	WR-28	WR-19
Waveguide Flange	UG-599/U	UG-383/U
Maximum Input (typical)	+5 dBm	+5 dBm
Damage Level	+10 dBm	+10 dBm
Acquisition Time (typical)	<2.5 sec	<2.5 sec
	Option 93	Option 94
578 Band Select	43	44
Waveguide Band	E	W
Range	60-90 GHz	90-110 GHz
Sensitivity (typical)	-25 dBm	-25 dBm
Waveguide Size	WR-12	WR-10
Waveguide Flange	UG-387/U	UG-387/U
Maximum Input (typical)	+5 dBm	+5 dBm
Damage Level	+10 dBm	+10 dBm
Acquisition Time (typical)	<2.5 sec	<2.5 sec

## TIME BASE (Standard)

Crystal Frequency	10 MHz
Stability:	
Aging Rate	< 3x10 <sup>-7</sup>  /mo.
Short Term	<1x10 <sup>-9</sup> rms for one second averaging time
Temperature	< 2x10 <sup>-6</sup>   over the range 0° to 50°C
Line Variation	±10% change in line voltage produces frequency shift < 1x10 <sup>-7</sup>
Warm-Up Time	None required
Output Frequency	10 MHz, square wave, 1V peak-to-peak minimum into 50 ohms
External Time Base	Requires 10 MHz, 1V peak-to-peak minimum into 300 ohms

## GENERAL

Resolution	Front panel keyboard select 1 Hz to 1 GHz
Measurement Time	1 msec for 1 kHz resolution 1 sec for 1 Hz resolution
Display	12 digit LED sectionalized to read GHz, MHz, kHz, Hz
Accuracy	±1 count ±time base error
Test	Front panel selected diagnostics
Sample Rate	Controls time between measurements, variable from 100 msec typical to 10 sec. Switchable HOLD position holds display indefinitely.
Reset	Resets display to zero and initiates new reading.
Offsets	Keyboard control of frequency and power offsets (with power meter Option 02). Displayed frequency (power) is offset by the entered value to 1 Hz resolution (0.1 dB power).
Multiply	Keyboard controlled. Counter will multiply the measured signal by any integer from 1 to 99 and display to 1 kHz resolution. Then OFFSET can be added or subtracted to obtain y = mx±b result.
Operating Temperature	0° to 50°C
Power	100/120/220/240/VAC ±10%, 50 to 60 Hz; 60 VA typical
Net Weight	~20 lbs. (9.07 kg)
Shipping Weight	~25 lbs. (11.34 kg)
Dimensions	3.5" x 16.75" x 14.0" (89 mm x 425 mm x 356 mm)
Accessories Furnished	Power Cord, Manual
SOURCE LOCKING SPECIFICATIONS	
Frequency Range	10 MHz-Max. capability of counter.
Resolution	10 kHz for phase lock freq. ≥ 50 MHz 2.5 kHz for < 50 MHz
Accuracy	Equal to counter's Time Base
Long Term Stability	Equal to counter's Time Base
Minimum Phase Lock Signal Level	Equal to counter sensitivity
Polarity	Automatically selected
Bandwidth	User select, 10 kHz, 2 kHz or 500 Hz, or automatically selects widest bandwidth capable of locking.
LOCK TIME (Typical)	
Coarse Tune	50 m sec + 1 counter acquisition



**Phase Lock**  
**Recall Stored Data**

time for source bandwidth greater than 100 Hz; limited by source tuning speed below 100 Hz.  
200 m sec  
1 counter acquisition + 100 m sec limited by source tuning speed.

**OUTPUT DRIVE**  
**(Maximum)**  
**Coarse Tune Output**  
**Phase Lock Output**

+ 10 V into 5 K ohm min.  
±10 V into 5 K ohm min for source gain constant <64 MHz/V.  
±75 MA into 10 ohm max for source gain constant <3.2 MHz/MA.  
±.6 V into 5 K ohm min for source gain constant ≥64 MHz/V.  
±4.5 MA into 10 ohm max for source gain constant ≥3.2 MHz/MA.

**CAPTURE RANGE**  
**Coarse Tune**

Entire range of selected counter band limited by maximum output drive.

**Phase Lock**

Source gain constant X maximum output drive.

**OUTPUT CONNECTOR**

**Coarse Tune**

Rear panel BNC, female

**Phase Lock**

Rear Panel BNC, female

**PHASE LOCKED**

**SPECTRUM** (See figure page 3)

**Noise Floor vs Input Frequency:**

The noise floor extends from the carrier to approximately the loop bandwidth. Beyond this the noise floor decreases 12 dB/ bandwidth octave. The noise floor is the greater of:

1. NOISE FLOOR = .70 dBC/Hz
2. NOISE FLOOR = (20 log F -65) dBC/Hz  
where F = Input frequency in GHz

**REQUIRED SOURCE CHARACTERISTICS**

**External Sweep**

**(Coarse Tune) Input:**

**Bandwidth** 5 Hz minimum  
**Tuning Sensitivity** 10 MHz/V minimum;  
10 GHz /V maximum

**FM (Phase Lock) Input:**

**Bandwidth** 2 kHz minimum

**Tuning Sensitivity**

**Voltage Driven Input** ±2 MHz/V minimum  
±1000 MHz/V maximum

**Current Driven Input**

±0.1 MHz/mA minimum  
±50 MHz/mA maximum

**MAXIMUM FM**

The counter will still frequency stabilize if maximum FM is exceeded, but accuracy and long term stability will not equal the counter's time base.

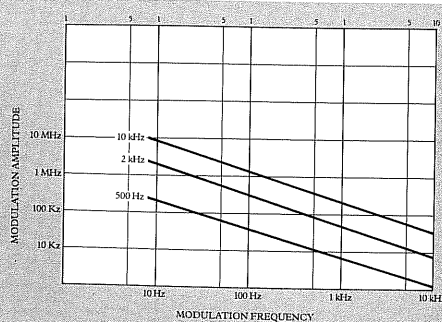

**OPTION 01 D TO A CONVERTER**

Option 01 will convert any three consecutively displayed digits to an analog voltage output. A display of 000 produces 0V output; 999 produces .999V full scale. Output is updated after every display update.

<b>Accuracy (25°C)</b>	±0.5% ±1 mV
<b>Temperature Stability (0-50°C)</b>	±0.01%/°C
<b>Resolution</b>	1 mV
<b>Load Impedance</b>	1 K ohm minimum
<b>Connector</b>	BNC female (on rear panel)

**OPTION 02 POWER MEASUREMENT**

Option 02 measures power of signals applied to the Band 3 input. Power and frequency are simultaneously displayed to 0.1 dB and 100 kHz resolution, respectively. Option 02 also allows power offsets from -99.9 dB to 99.9 dB (0.1 dB resolution) to be input from the keyboard.

<b>Frequency Range</b>	1-18 GHz (575) 1-26.5 GHz (578)
<b>Accuracy</b>	±1.2 dB Typical (0°-50°C) ±0.5 dB Typical (25°C)
<b>Resolution</b>	Power: 0.1 dB Frequency: 100 kHz to 1 GHz (selectable)
<b>Minimum Level</b>	Equal to counter sensitivity
<b>Maximum Operating Level</b>	+7 dBm
<b>Damage Level</b>	+37 dBm
<b>Measurement Time</b>	1 Gate Time + 50 msec + Frequency Measurement Time
<b>Measurement Window</b>	25 MHz nominal

**TIME BASE OPTIONS\***

Option	03	04	05
<b>Aging Rate Per 24 Hours (After 72 hours warm-up)</b>	<  5x10 <sup>-9</sup>	<  1x10 <sup>-9</sup>	<  5x10 <sup>-10</sup>
<b>Short Term Stability 1 Sec. Avg.</b>	<  1x10 <sup>-10</sup> rms	<  1x10 <sup>-10</sup> rms	<  1x10 <sup>-10</sup> rms
<b>0°C to +50°C Temperature Stability</b>	<  6x10 <sup>-8</sup>	<  3x10 <sup>-8</sup>	<  3x10 <sup>-8</sup>
<b>±10% Line Voltage Change</b>	<  5x10 <sup>-10</sup>	<  2x10 <sup>-10</sup>	<  2x10 <sup>-10</sup>

\*All Time Base Options utilize a proportional control oven which is energized whenever line cord is connected to AC sources.

**OPTION 06 EXTENDED FREQUENCY CAPABILITY**

Model 578 only

Internal option used in conjunction with Model 590 and Remote Sensor options 91 to 94. Allows extended frequency measurement from 26.5 GHz to 110 GHz, depending on which Remote Sensor Option is used.

**OPTION 08 — GPIB**

Included as standard equipment on IEEE STD 488-1978 both the Model 575 and 578.

**OPTION 09 — REAR INPUT**

**OPTION 10 — CHASSIS SLIDES**

**ACCESSORIES**

- Model 590 Frequency Extension Cable Kit
- Carrying Case
- Rack Mount Kit
- Calibration Kit