

701605/701610/701620 Digital Oscilloscope DL1620/DL1640/DL1640L

Signal Explorer



Functions

- 4 channels, 200 MS/s (DL1640/DL1640L)
- 2 channels, 200 MS/s (DL1620)
- 200 MHz analog bandwidth
- Maximum memory length: 32 MW (DL1640L) and 8 MW (DL1640/DL1620)
- 6.4-inch wide-angle-view TFT color LCD
- Compact and lightweight (approx. 3.9 kg)
- A4 size or smaller footprint
- Internal storage media (select PC card drive, Zip® drive, or FDD)
- USB compliant (optional)
- Ethernet connectivity (optional)
- Real-time digital filtering
- I²C bus trigger and analysis functions (optional) *NEW*
- DC power model and Battery box (701680) for DL1640/DL1640L *NEW*
- CAN bus signal analysis Function (optional) *NEW*



★ Safety Standard; EN61010-1
Emission; EN61326 Class A
Immunity Standard; EN61326



CAN Bus Signal Waveform Observation and Analysis *NEW*

■ CAN Bus Trigger Functions

- Start-of-Frame trigger
- Identifier (ID) Field trigger: 4 IDs can be specified.
- RTR Field trigger: The trigger is activated by Remote frame.
- Data Field trigger: You can set data of 1 to 8 bytes.
- Error Frame trigger

You can set trigger conditions with a combination (logical AND) of these five types of triggers. Determine bus level (recessive or dominant) by specifying the sample point as a percentage of the total bit time.

■ CAN Bus Analysis Functions

Use up to 32 megawords of memory (DL1640L) to acquire long strings of CAN bus waveform data and then analyze the data in a time-series manner. Analysis results are then listed along with the waveform. Results include: ID and Data fields, ACK field status and other information. The frame which is highlighted by the cursor on the analysis results list automatically appears in the zoom window. This feature enables you to observe the bus signal while concurrently viewing the analysis results. Thus, you can easily verify how noise or level fluctuations affect the communication data and carry out debugging work very efficiently.



Trigger Conditions Setup Menu

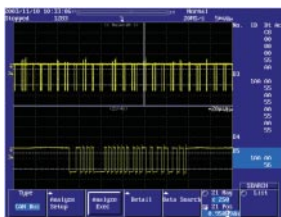

Waveform Display and Analysis Results

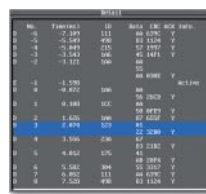

Detailed Analysis Results

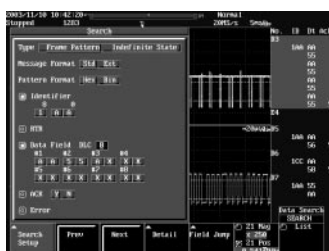

Data Search Setup Menu

■ Data Search and Field Jump Functions

Use the high-speed data search function to search all acquired frames. Search for user-specified ID, RTR, Data, or ACK codes.

This function can also search for error frames. A magnified view of the frame found is shown in the zoom window. This function can also search for a frame containing an Indefinite state. Even for frames comprising as few as 100 bits, the Field Jump function automatically finds the starting point of a Data or Control field and shows it in the zoom window.

The CAN cursor function displays the selected Field range, and lets you move bit-by-bit in the field for easy troubleshooting.



Stuff Bit Display

■ Stuff Bit Calculation Function

This function calculates and extracts the stuff bit from the frame data and represents it as a waveform. This enables you to easily confirm codes of waveforms.

The Mobile SignalExplorer: from the Lab to the Field

A 3-mode power supply (DC power model) that adapts to the various measuring environments, for in-vehicle tests and field use.

Mode 1: DC 12 V Input

The DL can be driven directly from an in-vehicle battery.

Mode 2: External Battery Drive

The DC power model yields approximately 2 hours* of operation using the battery box (with internal charger).

Acquired waveforms are unaffected by the power supply noise.

Mode 3: AC Input

The battery box acts as the AC adapter when an AC input is available.

You can measure signal continuously even when the power supply experiences trouble such as a power failure or voltage drop.*

*The operable time varies depending on usage condition.



DC power model + battery box

The DC power model is available on the DL1640 or DL1640L. The main unit must be connected to ground.

For Long-Duration or Repeating Measurements

- Simultaneous measurement on 4 channels, using the 32 MW super-long memory
- History memory stores up to 16,000 waveforms

Recorder-Like Roll Mode Display

- High speed roll mode display from 50 ms/div
- Calculates and displays waveform parameters during roll mode display, such as P-P, MAX, and Freq
- Zoom display available without stopping the waveform acquisition

The SignalExplorer That Instantaneously Guides You to the Target Waveform

Exploration 1: Super-Long Memory and Quick Zoom for Finding the Target Signal in Long-Period Phenomena

Super-long memory enables you to capture high-speed phenomena for the desired period of time, while providing fast sampling speeds required for reliable measurements. Up to 32 MW of data (with the DL1640L) can be acquired even when all four channels are used. As shown in the picture, during the evaluation of a switching power supply, for example, this capacity lets you capture three different signals (switching element voltage, current, and primary-side surge current) from the time the power is turned on until switching starts and stabilization occurs. Super-long memory also lets you maintain high-speed sampling, so individual pulses can be accurately displayed on the screen. The zoom function rapidly displays the target phenomenon contained in large amounts of waveform data. The Dual Zoom function enables you to zoom in on two portions of the waveform at one time.



32 MW long memory and Dual Zoom

Exploration 2: All-Points Display and Fast Screen Updating for Capturing Hidden Abnormal Phenomena

All-points display shows all of the data stored in long memory. This display mode shows phenomena that may be missed in a compressed waveform display. With Yokogawa's proprietary Data Stream Engine II, screen updating speed does not slow down even during zoom display or automatic parameter measurement. With fast screen updating, display changes corresponding to modified settings take place instantaneously, so instrument control is responsive.

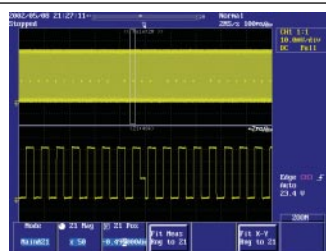

All-points display example

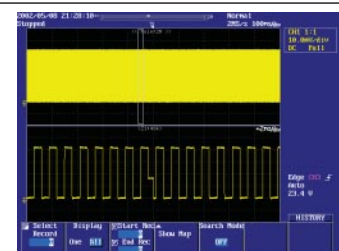

Conventional compressed display

The Serial Bus Signal Explorer

Long Memory and Analysis Functions Optimized for I²C Bus and SPI Evaluation

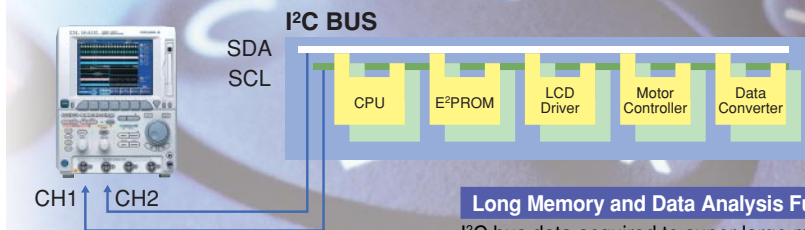

Capture Desired Data with the I²C Bus Trigger

The I²C trigger types are: Start Trigger (bus start condition), Non-Ack Trigger (when acknowledgement bit is not received), and Address (7 bit address + 1 read/write bit) & Data (1 byte data) Trigger. The I²C triggers described above can be also combined with other signals on channels 3 or 4. For example, a Start trigger could be combined with a control or feedback signal.

Long Memory and Data Analysis Functions

I²C bus data acquired to super large memory (32 M words/channel maximum) are analyzed in a time series. Analyzed results are decoded and displayed one byte at a time. The function can analyze very long data sequences up to 40,000 bytes. When a cursor is moved over the onscreen data, the corresponding waveform can be automatically enlarged in the zoom area. Easy comparison with communication data and the displayed waveforms enables effective debugging. Alternately analyze 2 I²C buses using all 4 channels: SCL1-Channel 1, SDA1-Channel 2, SCL2-Channel 3; SDA2-Channel 4.

SPI Analysis Function

The I²C bus analysis option also offers SPI bus analysis. SPI bus is a synchronous 8-bit serial bus widely used for Inter-IC communication. **Analysis Results Display** You can simultaneously display waveforms and Data1, Data2, and CS information. Data highlighted using a cursor is enlarged in the Zoom window. Upper and Lower threshold levels can be set to search for indefinite data. **Data Search Function** Automatically detects a specified data pattern from the target data.

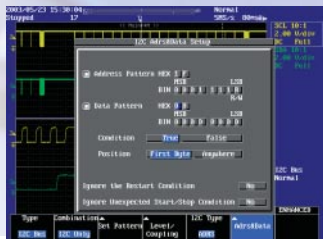

Trigger condition setup with address: 1F and first byte data: 00

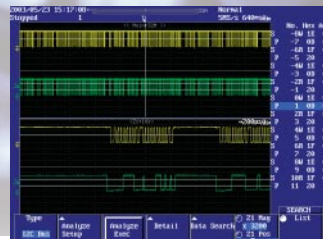

Analysis results of 6.4 seconds of I²C data.

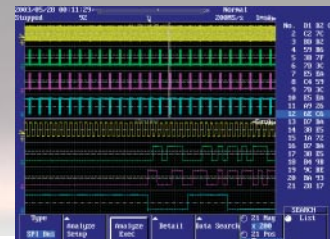

SPI analysis results display

Exploration 3: Smart Search Function for Effective Access to the Data You Need

"I want to find the serial data with a particular serial pattern", "I need to search for surge pulses of less than 30 ns", "I want to only extract waveforms that occasionally overshoot by an excessive amount".....As data volume increases, it becomes more important to be able to search for target phenomena efficiently. The Smart Search function automatically detects serial patterns, pulse widths, rising edges, falling edges, and other phenomena in the captured waveform data. These phenomena are then displayed in the zoom screen. Smart Search will significantly improve the efficiency of your development and evaluation work.

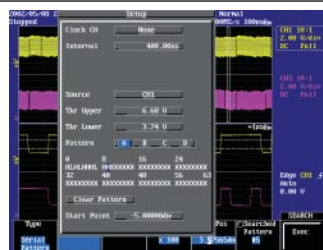

Serial pattern search setup

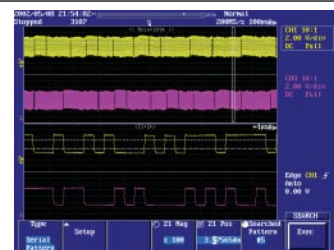

Serial pattern search results

Exploration 4: Real-Time Digital Filtering for Finding Signals Hidden in Noise

One important role for oscilloscopes is measuring noise in the waveforms. Sometimes, however, this noise prevents you from observing the target signals. The real-time digital filtering lets you easily apply a low pass filter while capturing data, so that waveforms hidden in noise can be clearly displayed.

Filters can be set separately on each channel. In combination with an analog filter, cutoff frequencies ranging from 20 MHz to 10 kHz can be set. In addition, when the real-time digital filtering is used in high-resolution mode, data resolution increases to up to 13 bits, and signals can be reproduced even more accurately on the screen.



Data Stream Engine II with internal digital filters

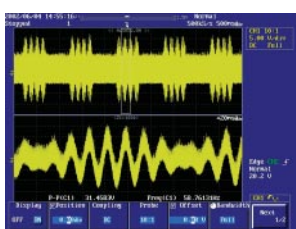

Without filtering (200 MHz BW)
Waveform mixed with noise

Filter ON



Filter cutoff frequency: 10 kHz
Waveform without high-frequency noise

A Variety of Functions to Provide the Best Solutions for a Wide Range of Measurement Needs

Have you ever missed an abnormal waveform because it disappeared from the screen before you pressed the stop key?

The Advanced History Memory Function Reliably Captures the Waveforms You Want.

History Memory

The history memory now has increased capacity for automatically storing data. History memory can now store up to 16,000 captured waveforms, depending upon record length.

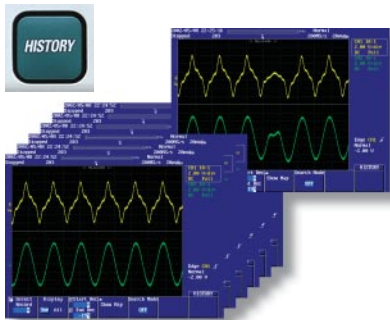

History Search

It would be difficult to search manually through thousands of history waveforms. Yokogawa's history search function automates this process for you. The history search lets you define zones on the screen, and find all previously captured waveforms that either pass through or bypass the user-defined zone. You can also run searches based on specified waveform parameters.

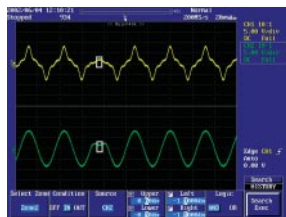

History Waveform Parameter Statistical Calculation

This function performs statistical calculations on waveform parameter values stored in history memory. Parameter maximum value, minimum value, average value, and standard deviations can be calculated and displayed. You can view the calculation results for each waveform on a full-screen menu.

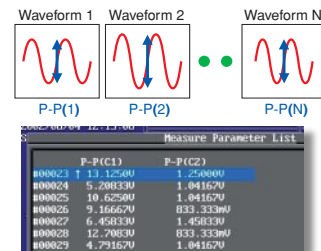

Simple and Enhanced Triggers

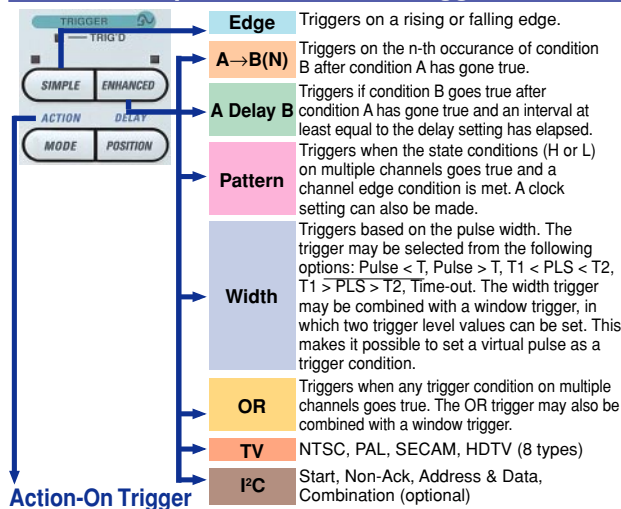

Action-On Trigger

With the action-on trigger, a specified action is automatically executed each time the trigger is activated. You can use the trigger for a variety of actions, such as automatically saving captured data. The action-on trigger is useful for purposes such as collecting data in continuous tests.

Frustrated by the many limitations of oscilloscope roll mode? The roll mode function goes beyond what a recorder can do, allowing you to record low-speed signals in real time.

Roll Mode, Waveform Calculation, and Envelope Mode

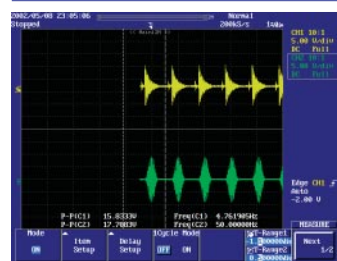

Roll mode is effective for observing low-speed signals. In this mode, the waveforms move across the display similar to the way a recorder operates. With the DL1600 series, roll mode can be set as fast as 50 ms/div. They have fewer roll mode limitations than other oscilloscopes. This function allows you to observe waveforms in roll mode, while checking zoomed waveforms and results from waveform parameter calculations such as peak-to-peak values, frequency, and FFT calculations. Envelope mode allows you to maintain a sampling speed of 200 MS/s regardless of the time-axis setting. This ensures that high-speed noise such as a surge pulse is captured, even when you are observing slow phenomena in roll mode.

Want to compare parameter values for each cycle starting as soon as the power is turned on?

Cycle Statistical Calculations



During power supply evaluations, this function lets you calculate voltage and current maximum values and periods for each switching cycle starting as soon as the power is turned on. Maximum value, minimum value, average value, and standard deviations are calculated automatically for each waveform parameter. In

addition, you can instantaneously search for the cycle containing the maximum or minimum value and display it on the zoom screen.

Do you often count the number of pulses on the screen? With many pulses this is time consuming

Pulse Count

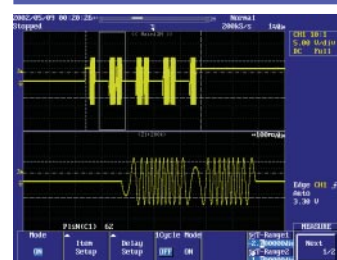

During the evaluation of electronic circuits, you often need to count the number of pulses, such as the number of rotation pulses in stepping motors, tracking error signals on optical disks, interrupt signals from a MPU, and clocks of serial data buses. The pulse count function automatically calculates the number of pulses in a waveform.

DIGITAL OSCILLOSCOPES



DL1620/DL1640/DL1640L

Advanced Networking and PC Connectivity

Web Server Functions

Connect the DL1600 series to your PC through the Ethernet connection. This allows for easy remote operation using Internet

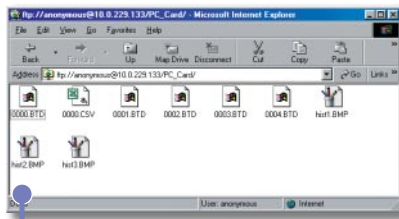

FTP

Easily copy and paste files to and from a PC from the internal flash memory drive and other internal storage media. You don't have to use a separate program to transfer the data.

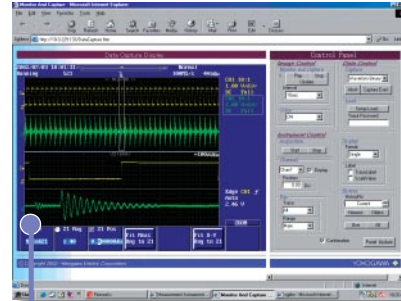

Data Capture

Download screen images periodically or manually. Download waveform data. Start or Stop a measurement, or setup a split display by using this menu.

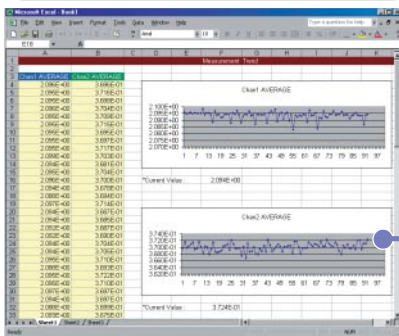

Measurement Trend

This function downloads values of waveform parameters periodically, activates MS Excel automatically, and graphs the calculated values on the PC. This enables you to check the parameter trends at a glance.

Save and Load Data

Do you want to save your data immediately but lack the proper storage media?

Internal Flash Memory Drive

An internal flash memory drive (2 MB) is available. Now you can save setup data, waveform data, and screen images even if you don't have other storage media at hand. Your data is always saved to flash memory, so you won't lose anything if the power turns off. When saving captured waveform data, it's possible to compress the data (decimation or peak-to-peak) based on the available storage capacity on the drive.

PC Card Interface (Type II)

If you select a PC card interface as the internal storage medium, you can use a large-capacity Microdrive or hard disk in addition to an ATA flash memory card or CompactFlash. This lets you save up to 32 MW of data on four channels. (A floppy drive or Zip® drive can be selected instead of the PC Card option)

Save a Waveform to the Screen with a Single Touch

When you find exactly the right waveform...



Snapshot Function

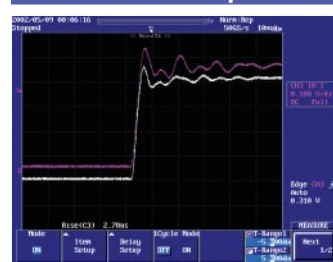

When you want to save waveform data, it's not easy to press multiple keys while keeping the probe on the target point with one hand. The snapshot function lets you save waveform data to the screen with a single touch, making comparing waveforms easier. In addition, waveform data saved with the snapshot function can be saved to storage media, then loaded later.

Easily Print, Save, and View Screenshots

Want to check saved screenshots quickly?

The **COPY** key lets you output images to the built-in printer, a USB printer, or a network printer.



Simply press the **IMAGE SAVE** key to quickly and easily save image data to a PC card or other storage media. Data can be saved in BMP, TIFF, PS, PNG, and JPEG formats.

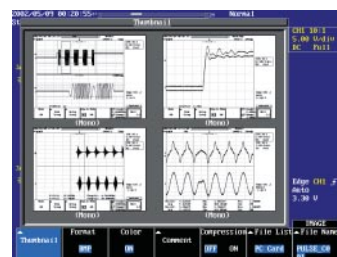

You can easily review thumbnail images. Both the image and file name are displayed. On the review screen you can check the images, and also change file names and delete files.



A Full Range of I/O Ports and Accessories to Support Your Measurement

Rear Panel Ports for Connection to a Wide Range of Peripherals

Probe power ports (optional)

These ports connect with current probes (700937, 701930, 701931) and a differential probe (701920, 701921, 701922, 700924, 700925).

USB port for PC control (optional)

This port lets you control the SignalExplorer using a PC.

USB ports for peripheral devices connection (optional)

Type A connector: 2 ports
Works with a USB keyboard/printer/mouse.

GO/NO-GO judgment I/O port

Input waveform determination timing signals and output results as TTL level signals using the GO/NO-GO judgment function.

GO/NO-GO Judgment Function

This function determines waveform data in a measured waveform based on specified zones or waveform parameters and automatically performs a specified action. Available actions include printing screen images, saving waveform data, sounding an internal buzzer, and sending an email.

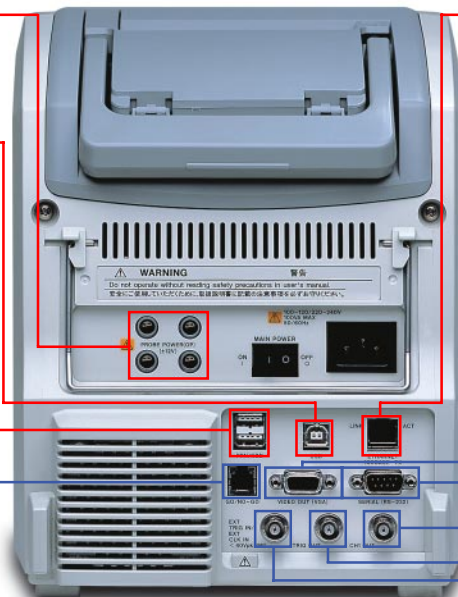
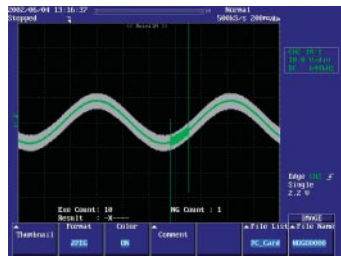

Ethernet port (optional)

Supports 100BASE-TX and 10BASE-T. Selective optional port from GP-IB or Ethernet

VGA video port

This port outputs video signals so that waveforms can be checked on an external monitor.

Serial port (RS-232)

CH1 output

This port normalizes and outputs the CH1 input signal. It can be used to connect a measurement instrument such as a counter.

Trigger output

This port outputs a TTL level trigger signal.

External trigger input/external clock input

This port can be used to input a trigger signal which is separate from the input signal. In addition, it can be used as an input port for an external sampling clock signal (40 Hz to 5 MHz).

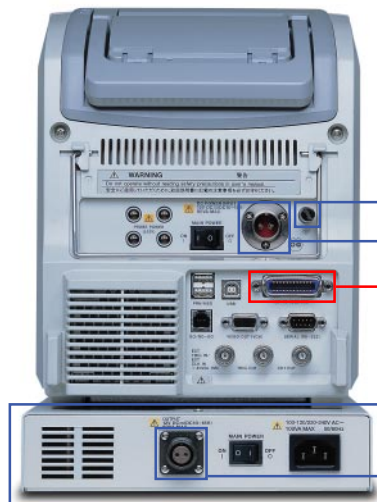

Rear Panel Ports for DC Power Model

The protective grounding terminal

Metal Plug for connecting to the Battery Box

GP-IB port (optional)

Selective optional port from GP-IB or Ethernet

701680 Battery Box

Metal Plug for connecting to the main unit

Software for Waveform Measurement on a PC

Software for Remotely Controlling the DL Series

Wirepuller

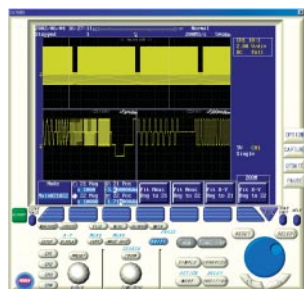

The Wirepuller software program displays a screen image of the DL's front panel on your PC so that you can monitor waveform signals. In addition, you can use the PC's mouse and keyboard to control the DL. The DL can be controlled via an Ethernet, USB, or GP-IB.

This software program can be downloaded from the following URL (requires registration):
<http://www.yokogawa.com/tm/wirepuller/>
Further details are available at the YOKOGAWA web site.

Software for Using Your PC to Check Waveform Data Captured in Long Memory

Waveform Viewer for DL Series

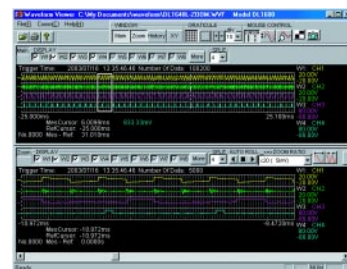

The Waveform Viewer software program lets you view waveform signals on your PC just as they appear on the DL screen. This includes zoom display, X-Y display and the history memory thumbnail displays. In addition, data can be converted to CSV format for use in programs like Excel.

A trial version of this Software program can be downloaded from the following URL:
<http://www.yokogawa.com/tm/700919/>
Further details are available at the YOKOGAWA web site.

Main Unit Specifications

Basic Specifications

Input Channels	4 (701610, 701620) 2 (701605)
Input Coupling	1 M Ω AC, 1 M Ω DC, GND
Input Impedance	1 M Ω \pm 1.0%, 28 pF at 1 MHz
Sensitivity	2 mV/div to 10 V/div (in steps of 1, 2, or 5)
Maximum Input Voltage	300 V DC or 300 Vrms CAT I, 424 Vpeak
Maximum DC Offset Range	2 mV/div to 50 mV/div: \pm 1 V (with 1:1 probe attenuation ratio) 100 mV/div to 500 mV/div: \pm 10 V 1 V/div to 5 V/div: \pm 100 V 10 V/div: \pm 50 V
DC Accuracy ¹	10 mV/div to 10 V/div: \pm 1.5% of 8 div + offset voltage accuracy 2 mV/div to 5 mV/div: \pm 2.0% of 8 div + offset voltage accuracy
Offset Voltage Accuracy ¹	2 mV/div to 50 mV/div: \pm (1% of setting + 0.2 mV) 100 mV/div to 500 mV/div: \pm (1% of setting + 2 mV) 1 V/div to 10 V/div: \pm (1% of setting + 20 mV)
Probe Attenuation Ratio	1:1, 10:1, 100:1, 1000:1
Frequency Characteristics ¹	Current probe (700937, 701930, 701931) 10 mV/div to 10 V/div: DC to 200 MHz 2 mV/div to 5 mV/div: DC to 80 MHz (using 700960; specified at probe tip)
Vertical Resolution	8 bits (24 LSB/div) High resolution mode: Maximum 13 bits
Maximum Sampling Rate	During real-time sampling: 200 MS/s During equivalent time sampling: 50 GS/s
Maximum Record Length	701605, 701610: 8 MW/ch (in single trigger mode) 1 MW/ch (in other modes) 701620: 32 MW/ch (in single trigger mode) 4 MW/ch (in other modes)
Sweep Time	2 ns/div to 800 s/div (varies depends on memory length)
Time Base Accuracy ¹	\pm 0.005%
External Clock Input	Input frequency range: 40 Hz to 5 MHz (continuous clock only)

Trigger

Trigger Modes	Auto, Auto Level, Normal, Single, Single (N)
Trigger Sources	CH1 to CH4, LINE, EXT
Trigger Types	Edge, A \rightarrow B(N), A delay B, OR, pattern, pulse width, TV (NTSC), PAL, SECAM, 1080/60p, 1080/60i, 1080/24p, 1080/50i, 1080/25p, 1080/24sf, 720/60p, 480/60p), I ² C (optional)

Display

Display	6.4-inch TFT color liquid crystal display ²
Screen Updating Rate	Up to 60 times per second during 100 kW all-points display Up to 30 times per second during 1 MW all-points display ² The LCD may contain some pixels that are always off or always on. In addition, brightness may vary due to the characteristics of the LCD, but this is not an indication of any problem with the display.

Functions

Vertical Horizontal Functions

Input Filter	20 MHz band limits can be set separately on CH1 through CH4.
Input Digital Filter	10 kHz to 1.28 MHz band limits can be set separately on CH1 through CH4.
Roll Mode	50 ms/div to 500 s/div (during auto, auto level, and single trigger modes) Note: 50 ms/div to 50 s/div at 10 kW 50 ms/div to 5 s/div at 1 kW

Waveform Acquisition/Display Functions

Acquisition Modes	Normal, averaging, envelope, high resolution
Record Length	701605, 701610: 1 kW, 10 kW, 100 kW, 1 MW, 8 MW (Single) 701620: 1 kW, 10 kW, 100 kW, 1 MW, 4 MW, 10 MW (Single), 32 MW (Single)
Zooming	Up to two locations can be set with separate enlargement ratios. (Display: Main, Z1 only, Z2 only, Main & Z1, Main & Z2, Main & Z1 & Z2)
History Memory	701605, 701610: Automatically saves acquisition data of up to 4,000 records. 701620: Automatically saves acquisition data of up to 16,000 records.
Display Format	The display can be split to one, two, or four windows (701610, 701620). The display can be split to one or two windows (701605).
X-Y Display	Two X-Y waveform displays (XY1 and XY2) can be displayed in separate windows.
Accumulate	Permits waveform overlaying (Persistence, Color)

Analysis Functions

Search and Zoom	Edge, Serial Pattern, Parallel Pattern, Pulse Width, Auto Scroll
History Search	Zones, Parameters
Cursor Measurement	Marker, Horizontal, Vertical, Degree, Vertical History
Automatic Waveform Parameter Measurement	Peak-to-peak, Max, Min, Avg, Rms, Sdev, High, Low, +Oshot, -Oshot, Int1TY, Int2TY, Int1XY, Int2XY, Freq, Period, Rise, Fall, +Width, -Width, Duty, Burst1, Burst2, Pulse, AvgFreq, AvgPeriod, Delay (between channels)

Waveform Parameters for Statistics

Parameters:	Listed above
Statistics:	Min, Max, Avg, Cnt, Sdv
Statistical modes:	Normal Statistics, Cycle Statistics, History Statistics
Math Function	Addition, Subtraction, Multiplication, Power Spectrum
GO/NO-GO Judgment	GO/NO-GO judgment based on waveform parameter measurement values or waveform zones

Screen Image Output

Built-in Printer (optional)	112 mm paper width Screenshot output as hard copy or enlarged and output on multiple pages.
External Printer (optional)	Output to external printer through USB or Ethernet port ESC/P, ESC/P2, LIPS3, PCL5, and BJ commands supported.
Floppy Drive, Zip [®] Drive, PC Card, and Network Drive	Output formats: PostScript, TIFF, BMP, JPEG, PNG

I²C Bus Analysis Option Specifications

Applicable Bus

I ² C Bus	
Bus Transfer Rate	Maximum 3.4 Mbps
Address Mode	7 bit
SM Bus	Complies with System Management bus

Analysis Functions

Waveform and Data Display	Simultaneous data display (in hex notation) and waveform
Detailed Data Display	Data transfer time starting at trigger point data and acknowledgement exist/not exist
Maximum Analyzed Data Size	40,000 bytes
Analyzed Channels	SCL: CH1, CH3, SDA: CH2, CH4 The two pairs of SCL and SDA can be analyzed alternately

Trigger

Trigger Source	CH1: SCL CH2: SDA CH3, CH4: Analog Signals Trigger activated by the Start Condition
Start Trigger	Trigger when No Acknowledgement bit is returned
Non-ACK Trigger	Compared with designated address
Address Trigger	Compared with designated data
Data Trigger	Address and Data trigger types
Combination Trigger	I ² C bus conditions with CH3/CH4 analog signals

Rear Panel I/O Ports

Communication Interfaces	Serial port (RS232), USB port (optional), USB-PC port (optional), GP-IB port (optional ¹), Ethernet port (complies with 10BASE-TX and 10BASE-T; optional ¹) ¹ Choose one from the Ethernet port and GP-IB port options.
Signal I/O	External Trigger Input/External Clock Input, Trigger Output, VGA video signal output, GO/NO-GO judgment I/O, CH1-OUT
Probe Power Port (optional)	Output ports: 4 (701610, 701620) 2 (701605) Output voltage: \pm 12 V

Battery Box (Used with DC Power Model Only)

Operable Time	Approx. 2 hours (varies depending on usage conditions)
Charging Time	Approx. 4.5 hours
Number of Charges (cycle life)	Approx. 500 (varies depending on usage environment)
Rated Output Voltage	12 V (14 V: AC power supply)
Rated Supply Voltage	100 to 120 VAC/220 to 240 VAC (automatically switches)
Rated Supply Frequency	50/60 Hz
Maximum Power Consumption	200 VA
Operating Temperature Range	5°C to 40°C (Operating conditions) 5°C to 35°C (Charging conditions)
Weight	Approx. 2.8 kg (6.2 lbs)
Exterior Dimensions	220 \times 50 \times 248 mm (WHD) 8.66 \times 1.97 \times 9.76 inch (WHD)

General Specifications

Exterior Dimensions	220 \times 266 \times 224 mm (WHD) 8.66 \times 10.47 \times 8.82 inch (WHD) (with printer cover closed; does not include protrusions)
Weight	Approx. 4.5 kg (10.8 lbs; with all options) Approx. 3.9 kg (8.6 lbs; without any options)
Operating Temperature Range	5°C to 40°C
AC Power Model	
Rated Supply Voltage	100 to 120 VAC/220 to 240 VAC (automatically switches)
Rated Supply Frequency	50/60 Hz
Maximum Power Consumption	100 VA
DC Power Model	
Rated Supply Voltage	DC 12 V (Rated 10-18 V)
Maximum Power Consumption	60 VA

1: Measurements taken based on internal clock after calibration, following warmup period under reference operating conditions (see below).
Operating Conditions Ambient temperature: 23 \pm 5°C
Ambient humidity: 55 \pm 10% RH

DIGITAL OSCILLOSCOPES



DL1620/DL1640/DL1640L

DL1620/DL1640/DL1640L

Model Numbers and Suffix Codes

Mode/Options	Suffix code	Description
701605		DL1620 digital oscilloscope
701610		DL1640 digital oscilloscope
701620		DL1640L digital oscilloscope
	-AC	100–120 V & 220–240 V
	-DC ¹	12 VDC
Power cable	-D	UL/CSA standard
	-F	VDE standard
	-Q	BS standard
	-R	AS standard
	-H	GB standard
	-Y	No power cable
Internal media drive	-J1	Floppy drive ²
	-J2	Zip [®] drive ²
	-J3	PC card drive (Type II) ²
Other options	/B5	Built-in printer
	/P2	Probe power for 701605
	/P4	Probe power for 701610 and 701620
	/C1	GP-IB + USB ³
	/C10	Ethernet + USB ³
	/F5	I ² C bus analyzer for 701610 and 701620 ⁴
	/F7	CAN bus signal analysis function ⁴

The main unit comes standard with four passive probes (700960) for 701610/701620 and two passive probes for 701605.

1 Select "-Y" for the DC power model.

2 Choose one.

3 Choose one.

4 The SPI analysis function is included with both the I²C bus analysis function and the CAN bus signal analysis function.

Model/Options	Suffix code	Description
701680 ⁵		Battery box with a charger
Power cable	-D	UL/CSA standard
	-F	VDE standard
	-Q	BS standard
	-R	AS standard
	-H	GB standard

5 The Battery box comes standard with the cable for connecting to the main unit.

Accessories

<p>50 MHz current probe (700937) Input range: 15 Apeak</p>	<p>10 MHz current probe (701930) Input range: 150 Arms</p>	<p>100 MHz 100:1 probe (700978) Maximum input voltage: ±4000 V</p>
<p>100 MHz differential probe (700924) Attenuation ratio: Either 1/100 or 1/1000 Maximum differential allowed voltage: ±1400 V</p>	<p>200 MHz differential probe (701922) Attenuation ratio: 1/10 (with 50 Ω load) Differential input voltage range: ±20 V</p>	<p>100 MHz differential probe (701921) Attenuation ratio: Either 1/10 or 1/100 Maximum differential allowed voltage: ±70 V (1/10), ±700 V (1/100)</p>

For detailed specifications, visit our homepage at

<http://www.yokogawa.com/tm/DL1600/>

[Sigma Explorer] is a registered trademark of Yokogawa Electric Corporation.]

Microsoft, MS, Windows, and Internet Explorer are trademarks or registered trademarks of Microsoft Corporation in the US and other countries.

Microdrive is a trademark or registered trademark of International Business Machines Corporation in the US and other countries.

Ethernet is a registered trademark of Xerox Corporation.

Zip is a trademark or registered trademark of Iomega Corporation in the US and other countries.

Other company names and product names appearing in this document are trademarks or registered trademarks of their respective companies.

Standard Accessories

Accessory	Quantity
Power cable ⁶	1
Passive probe (700960)	Number of channels
Transparent front cover	1
Soft case for probes	1
Printer roll paper (when option /B5 is selected)	1
User's manual (one set)	1

6 The power cable is included in the AC power model only.

Supplies

Product	Part number	Description	Order quantity
Printer roll paper	B9850NX	30-meter roll (one roll per package)	5
Passive probe	700960	10 MΩ (10:1), 200 MHz band, 1.5 meters, 1 probe per package	1
Front cover	B9989FA	For protecting LCD and front panel	1

Optional Accessories

Product	Model number	Description
100:1 probe	700978	100 MHz
Current probe	700937	DC to 50 MHz, 15 Apeak
Current probe	701930	DC to 10 MHz, 150 Arms
Current probe	701931	DC to 2 MHz, 500 Arms
Differential probe	700925	DC to 15 MHz
Differential probe	700924	DC to 100 MHz
Differential probe	701920	DC to 500 MHz ⁷
Differential probe	701921	DC to 100 MHz
Differential probe	701922	DC to 200 MHz ⁷
50 Ω terminator	700976	Pass-through type

7 The 50 Ω terminator (700976) is necessary for connecting to the main unit.

Exterior Dimensions

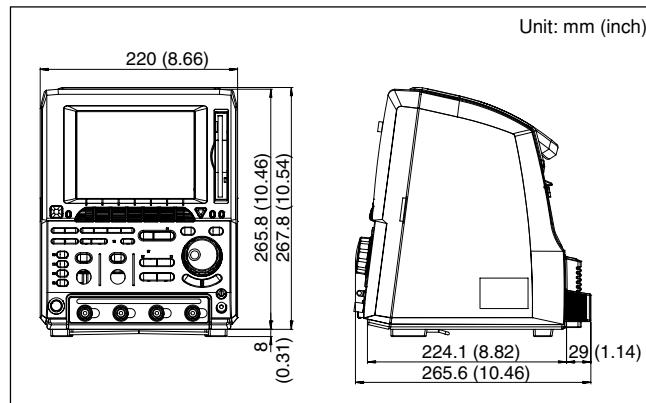

[Sigma Explorer] is a registered trademark of Yokogawa Electric Corporation.]

Microsoft, MS, Windows, and Internet Explorer are trademarks or registered trademarks of Microsoft Corporation in the US and other countries.

Microdrive is a trademark or registered trademark of International Business Machines Corporation in the US and other countries.

Ethernet is a registered trademark of Xerox Corporation.

Zip is a trademark or registered trademark of Iomega Corporation in the US and other countries.

Other company names and product names appearing in this document are trademarks or registered trademarks of their respective companies.

Yokogawa's Approach to Preserving the Global Environment

- Yokogawa's electrical products are developed and produced in facilities that have received ISO14001 approval.
- In order to protect the global environment, Yokogawa's electrical products are designed in accordance with Yokogawa's Environmentally Friendly Product Design Guidelines and Product Design Assessment Criteria.

NOTICE

- Before operating the product, read the user's manual thoroughly for proper and safe operation.
- If this product is for use with a system requiring safeguards that directly involve personnel safety, please contact the Yokogawa sales offices.