



WaveMaster® 8 Zi Series

4 GHz – 30 GHz

World's Fastest Real-time Oscilloscope
Eye Doctor™ II Advanced Signal Integrity Tools
Superior Serial Data Analysis



THE NEW OSCILLOSCOPE EXPERIENCE IS HERE

World's Highest Bandwidth Real-time Oscilloscope with Superior Performance

WaveMaster 8 Zi combines the highest bandwidth and sample rate with the superior performance of the X-Stream™ II architecture to maximize speed in all aspects—high bandwidth signal capture, 10–100x faster analysis processing, instantaneous instrument responsiveness, and 20x faster off-line data transfer. Availability of models from 4 to 30 GHz with complete bandwidth upgradability makes it easy and affordable to stay current with emerging high-speed technologies and serial data standards. In addition, all models include both 50 Ω and 1 MΩ inputs and support for every probe manufactured by LeCroy without requiring external adapters or probe amplifiers. Combined with LeCroy's flexible and deep analysis toolbox, the WaveMaster 8 Zi Series provides an unforgettable experience for the debugging, validation, analysis and compliance testing of electronic designs.





1. Industry leading performance—30 GHz bandwidth, 80 GS/s sample rate, 512 Mpts of analysis memory
2. Eye Doctor™ II Advanced Signal Integrity Tools improves signal integrity measurements with real-time de-embedding and emulation capabilities on full record lengths
3. Superior serial data analysis with SDA II software—more capability to decompose and analyze jitter and determine root cause quickly
4. X-Stream II streaming architecture—10–100 times faster than other oscilloscopes
5. Deepest toolbox with more measurements, more math, more power
6. Exceptional instrument responsiveness, even at maximum acquisition memory
7. 325 MB/s data transfer rate from oscilloscope to PC with LeCroy Serial Interface Bus (LSIB) option
8. Widest bandwidth upgrade range provides best investment leverage
9. 15.3" widescreen (16x9) high resolution WXGA color touch screen display—50% larger than 12.1" displays
10. TriggerScan™ detects and captures more anomalies per second
11. Low-speed serial triggering and decode (I²C, SPI, UART-RS232, CAN, LIN, FlexRay™) available to provide a total system view
12. WaveScan™ quickly and intuitively locates, analyzes and displays abnormal events even in long waveforms
13. 50 Ω and 1 MΩ inputs with both ProBus and ProLink probe interfaces on all models provide unsurpassed flexibility

LEADING PERFORMANCE, INNOVATIVE TECHNOLOGY

LEADING PERFORMANCE, INNOVATIVE TECHNOLOGY

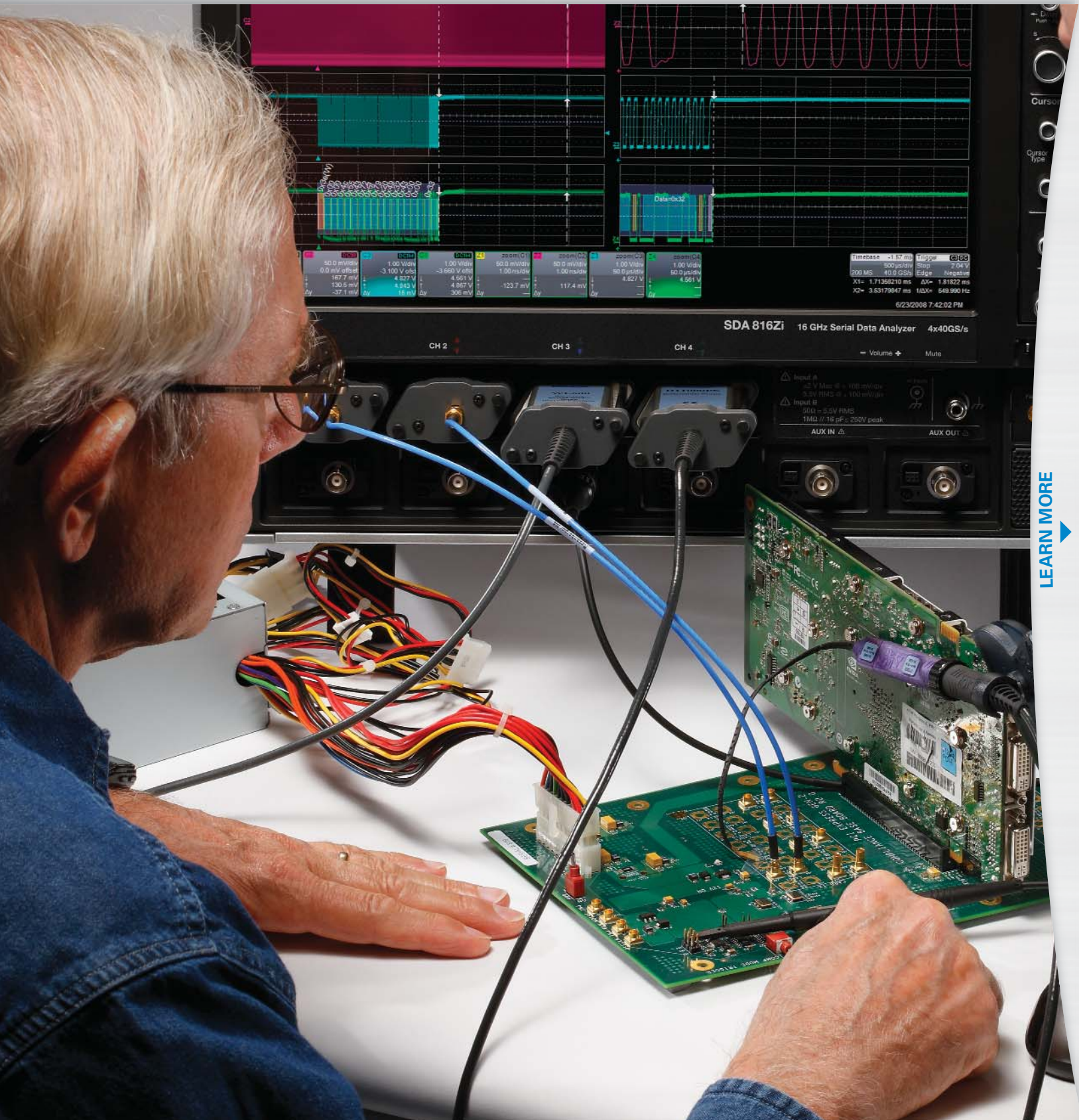

LEARN MORE

World's Fastest Single-Chip ADC

Monolithic, custom designed Silicon Germanium (SiGe) 40 GS/s Analog-to-Digital Converter (ADC) is the world's fastest single-chip ADC.

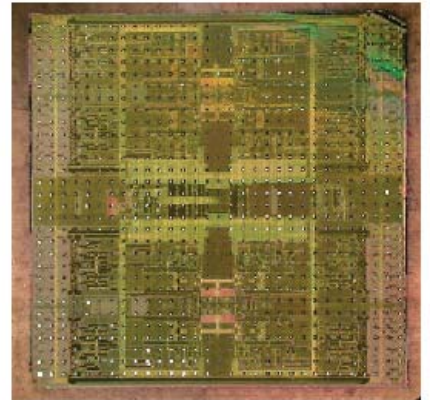

Innovative, Superior, Upgradeable

World's Fastest Real-time Oscilloscope

LeCroy has broken bandwidth barriers by combining custom designed SiGe high-speed components with 5th generation Digital Bandwidth Interleave (DBI) technology to achieve unprecedented real-time oscilloscope performance:

- 30 GHz
- 80 GS/s
- 512 Mpts/Ch Analysis Memory

Most Advanced Oscilloscope Platform

X-Stream II architecture provides 10–100x faster processing of long records, true 512 Mpts analysis memory, and instantaneous instrument responsiveness. When off-line data analysis is preferred, the LeCroy Serial Interface Bus (LSIB) provides up to 325 MB/s data transfer speeds. A 15.3" WXGA touchscreen display provides 50% more viewing area

compared to other oscilloscopes in this class. Both 50 Ω and 1 M Ω inputs are standard on all oscilloscopes, as is support for all LeCroy probes (including passive probes) without the need for easy to lose external adapters or expensive power supplies.

Eye Doctor™ II Advanced Signal Integrity Tools Add Measurement Precision

LeCroy's Eye Doctor II Advanced Signal Integrity Tools add precision to signal integrity measurements by allowing the subtraction of fixture effects, and the emulation of emphasis, serial data channels, and receiver DFE, FFE, and CTLE equalization effects while at the same time maintaining fast oscilloscope processing speed on unlimited record lengths. This allows the engineer to re-capture design margin, better understand actual circuit performance, and perform compliance testing on emerging

high-speed standards, such as PCIe Gen3, USB 3.0, SAS/SATA 6 Gb/s, that require emulation to ensure high field reliability and interoperability.

Superior Serial Data Analysis

SDA II Serial Data Analysis Software provides the highest confidence for serial data testing. Eye diagram analysis provides 100x faster capture of unit intervals (UI) in the eye diagram, and is enhanced with superior eye diagram analysis tools, such as lines of constant bit error rate (IsoBER) and mask violation locators. Superior jitter decomposition methodologies and analysis tools provides more ability to understand problem behaviors in serial data systems. X-Stream II architecture leverages the superior tools through 10–100x faster processing and complete analysis processing of full record lengths, providing more insight faster.

THE BEST HIGH BANDWIDTH INVESTMENT

5th Generation Digital Bandwidth Interleave (DBI)

As memory and sample rate can be interleaved, so can bandwidth. Using high-performance microwave and RF technologies, and high-speed processors and digital signal processing (DSP), LeCroy intelligently operates high-speed analog components comfortably within their rated bandwidth range while providing twice the four channel bandwidth on two channels. This approach offers better signal fidelity compared to “stretching” of components beyond their rated bandwidth.



Learn More

http://www.lecroy.com/tm/Library/WhitePapers/PDF/DBI_Explained.pdf

Custom Designed to Ensure High-performance

Silicon Germanium (SiGe) technology is deployed with IBMs 7HP process to create specialized analog-to-digital converters (ADCs), and

track/holds. There is one ADC and one track and hold per acquisition channel, located in close proximity to maintain good signal fidelity

and optimal response. The layout path is precisely controlled to maintain high signal fidelity for each channel.

Widest Bandwidth Upgrade Range: 4–30 GHz



WaveMaster 816Zi

SDA 830Zi



All WaveMaster 8 Zi oscilloscopes are implemented with a single hardware platform. To extend bandwidth beyond 16 GHz, LeCroy has leveraged DBI technology to minimize initial costs—the RF deck that doubles the bandwidth is a separate module that slides into a slot in the WaveMaster 8 Zi platform.

Best Investment Protection

From the perspective of bandwidth, sample rate, processing speed, responsiveness, display size, and range of capability, the WaveMaster 8 Zi platform is clearly superior and will remain so for many years to come. With the widest bandwidth upgrade range, an engineer who is working on 2nd generation technologies today can confidently know that WaveMaster 8 Zi will support 3rd or 4th generation technology needs several years from now.

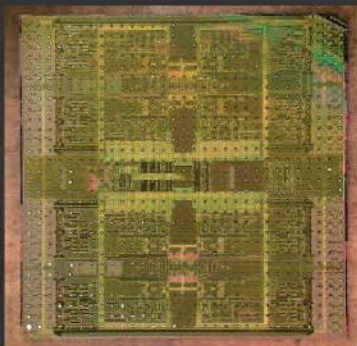
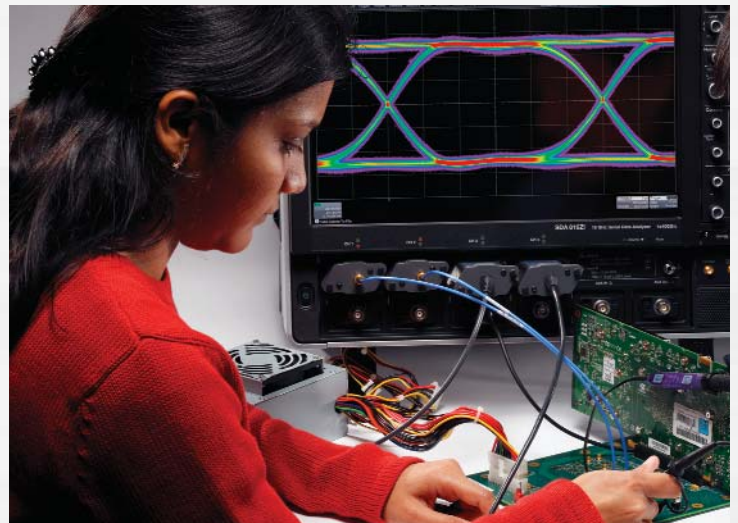

World's Fastest Single-chip ADC

The monolithic 40 GS/s ADC is the fastest single-chip ADC. Compared to other approaches that use multiple ADC chips per channel,

or single-chip ADCs with more than 100 interleaved converters, the LeCroy approach is a simpler more elegant solution for

Eye Doctor II Advanced Signal Integrity Tools

As signal speeds and data rates have increased into the microwave frequency range, engineers have had to face new challenges with signal integrity measurements. Eye Doctor II is a complete set of tools that adds precision to signal integrity measurements by permitting de-embedding and emulation (emphasis or receiver equalization) on full record lengths (up to 512 Mpts). By using Eye Doctor II, the engineer can eliminate the impact of unwanted devices, and design margin is recaptured. Eye Doctor II

uses industry-standard S-parameter measurements and Touchstone files that are easily uploaded into Eye Doctor II. All basic capability is easily accessible a streamlined, simple user interface. More advanced capability is accessible in through the Processing Web Editor. The complete LeCroy analysis toolbox, such as parameters, math functions, jitter tracks, histograms, eye diagrams, etc., may be further applied to any Eye Doctor II processed signal.

Test Fixture and Cable De-embedding

Even high quality test fixtures and cables have a negative impact on signal quality that increases disproportionately with higher signal frequency. If the test fixtures and cables can be electrically quantified in terms of S-parameters or attenuation factors, they can be removed from the measurement result.

Emphasis Emulation

Serial data channels have a disproportionate impact on the high frequency content of the serial data signal. Therefore, transmitter designers sometime employ the use of emphasis to pre-compensate for these effects. Either de-emphasis or pre-emphasis can be added or removed from a serial data signal with Eye Doctor II.

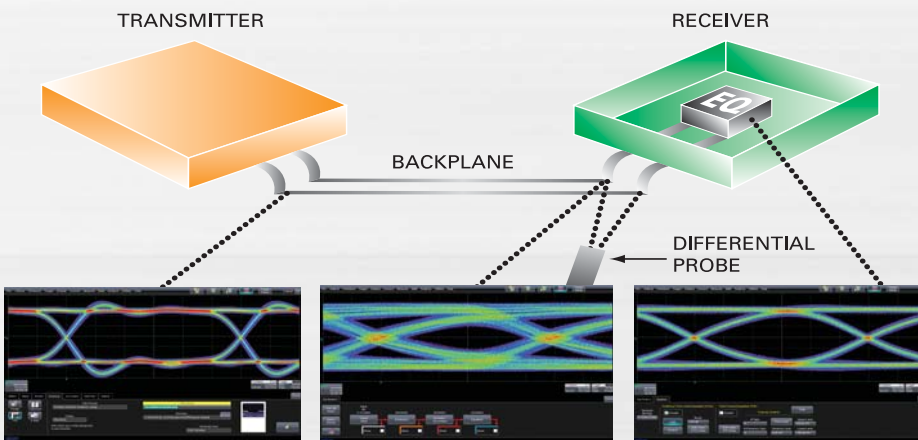

Serial data signal probed at the transmitter output shows acceptable response

Losses in the serial data channel affect the signal integrity. This effect can be de-embedded or emulated

The receiver usually applies equalization to "open" the eye. This equalization can be modeled to show how the signal appears to the receiver after equalization is applied

maintaining proper timing, phasing, and offset between the on-chip ADCs.



High-speed Memory

Custom high-speed memory chips on multiple memory plug-in cards achieve up to 256 Mpts/channel (or up

Add Precision to Signal Integrity Measurements

Serial Data Channel Emulation

When measuring serial datastreams, there are additional considerations. Most commonly, but not always, a design engineer will measure the serial data signal at the output of the transmitter. Therefore, it is commonly desired to emulate the serial data channel after the transmitter output. Some emerging high-speed standards, such as SuperSpeed USB or PCIe Gen3, require various test conditions to emulate a variety of serial data channels to ensure field reliability and interoperability.

It may also be desired to “virtually probe” the serial data signal in your circuit using a combination of de-embedding and emulation to allow a view of the signal anywhere in your circuit, regardless of whether you can actually probe there or not. Eye Doctor II makes this possible.

Receiver Equalization

Serial data receivers often incorporate equalization to compensate for the impact of the serial data signal as transmitted over the serial data channel and input to the receiver. Thus, it is possible for a “closed-eye” serial data signal input at the receiver to be equalized by the receiver and result a properly decoded signal. Eye Doctor II provides the ability to apply Feed Forward Equalization (FFE), Decision Feedback Equalization (DFE) or Continuous Time Linear Equalization (CTLE) and replicate or model the receiver equalization.

This would provide ability to view eye diagram and jitter performance on the signal as it is actually present at the receiver even though there was no way to access or probe the signal at the location of interest.

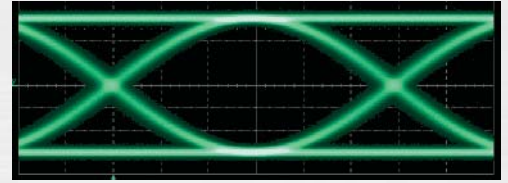

Open eye with 2.5 Gb/s serial data signal. At this data rate, the probed signal is mostly unaffected by serial data channel response.

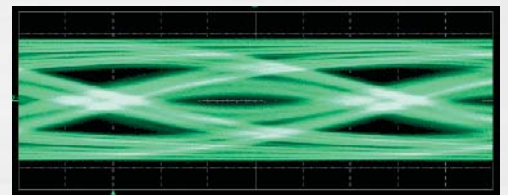

As the serial data rate increases, the attenuation in the backplane “closes” the eye diagram at the input to the receiver.

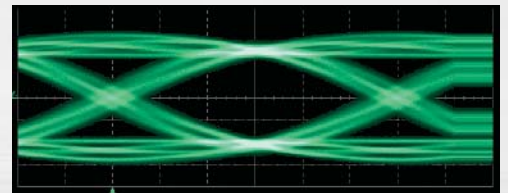

By using Eye Doctor II to apply serial data channel emulation to correct for backplane emulation, then using Eye Doctor to apply receiver equalization to mimic functionality of the hardware receiver, we can understand whether the signal as received by the receiver has acceptable jitter performance or not.

to 512 Mpts/Ch interleaved with some models and options). X-Stream II architecture ensures fast

and complete processing of full record lengths with no limitations on analysis memory.

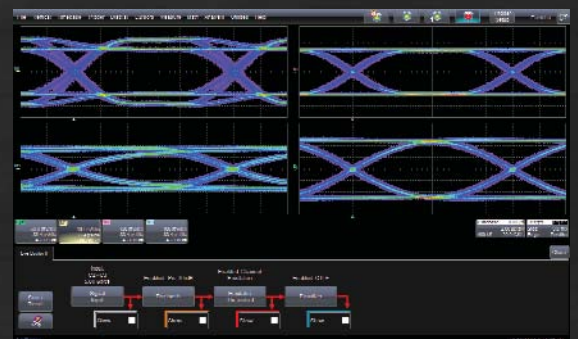

X-STREAM II FAST ANALYSIS AND RESPONSIVENESS

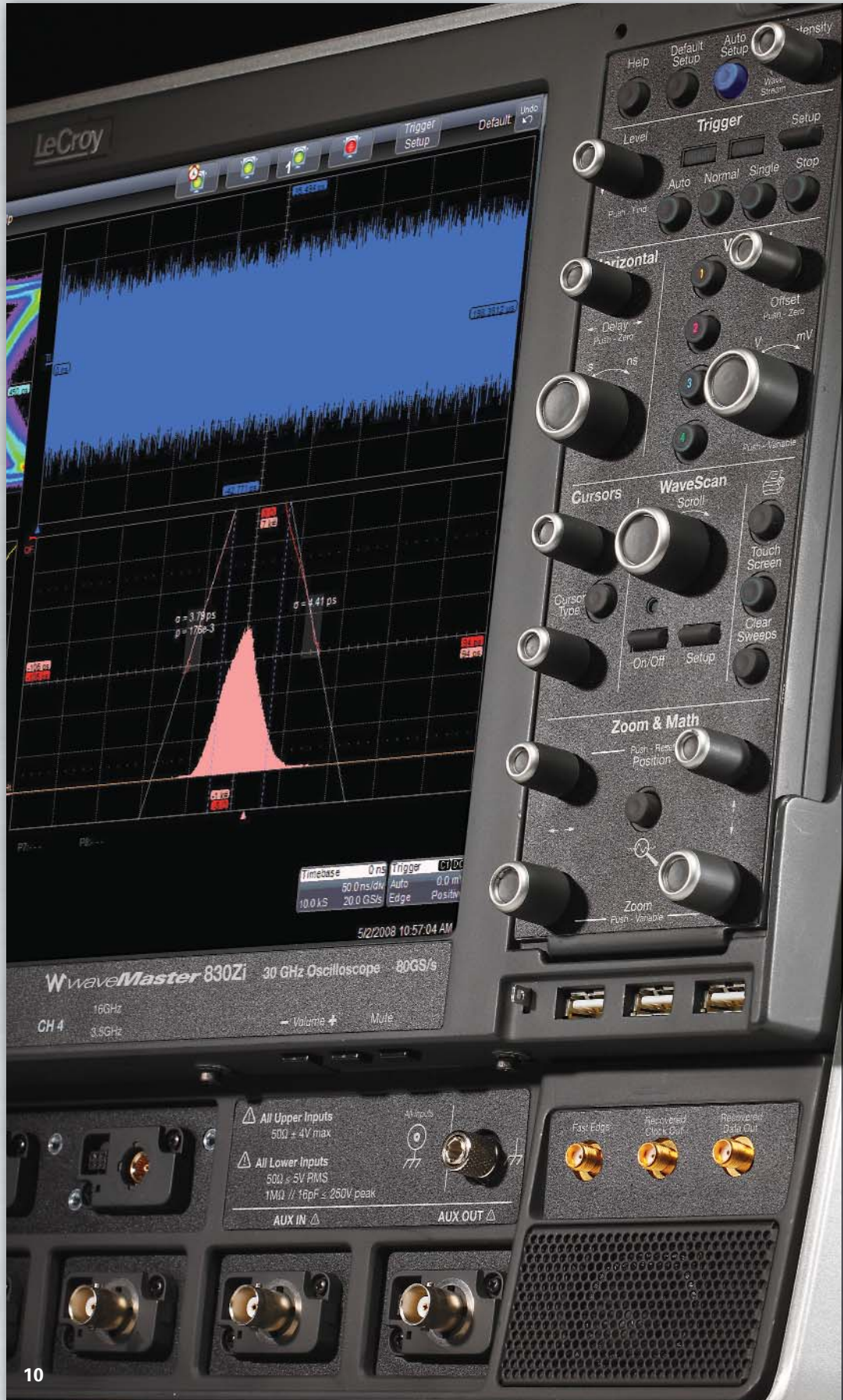

Deep Insight for Analysis

Applying the WaveMaster 8 Zi Series' flexible and deep measurement and analysis toolbox to characterize and validate a design creates understanding. That is Deep Insight. An oscilloscope's operating performance comes from the design that integrates the operating system, the hardware processor and the waveform processing method. Each component is important to the overall architecture performance but only the X-Stream II waveform processing method unleashes amazing speed performance and no compromise in responsiveness, thus drastically reducing the time to generate Deep Insight.

LeCroy – The Analysis Memory Leader

LeCroy has found a way to make long acquisition memory seamless and pain free to use. The WaveMaster 8 Zi Series' proprietary X-Stream II architecture supports capturing, zooming, measuring and analyzing multiple waveforms at up to 512 Mpts deep. WaveMaster 8 Zi's proprietary architecture design is augmented with an Intel® Core™ 2 Quad processor, high-speed serial data buses, a 64-bit OS and up to 8 GB of RAM. What you experience is a processing speed 10–100x faster compared to other oscilloscopes in this class.

Instantaneous Responsiveness

The first time you use the WaveMaster 8 Zi oscilloscope you will experience remarkable responsiveness. Acquiring and manipulating the longest record lengths and performing the most

X-Stream II Architecture

Optimized for Fast Throughput

X-Stream II architecture enables high throughput of data—even when the oscilloscope is performing multiple 100 Mpts (or larger) waveforms. X-Stream II uses variable waveform segment lengths to enable all processing intensive calculations to take place in fast CPU cache memory, thus improving calculation speed and efficiency. The result—10–100x faster processing compared to other oscilloscopes.

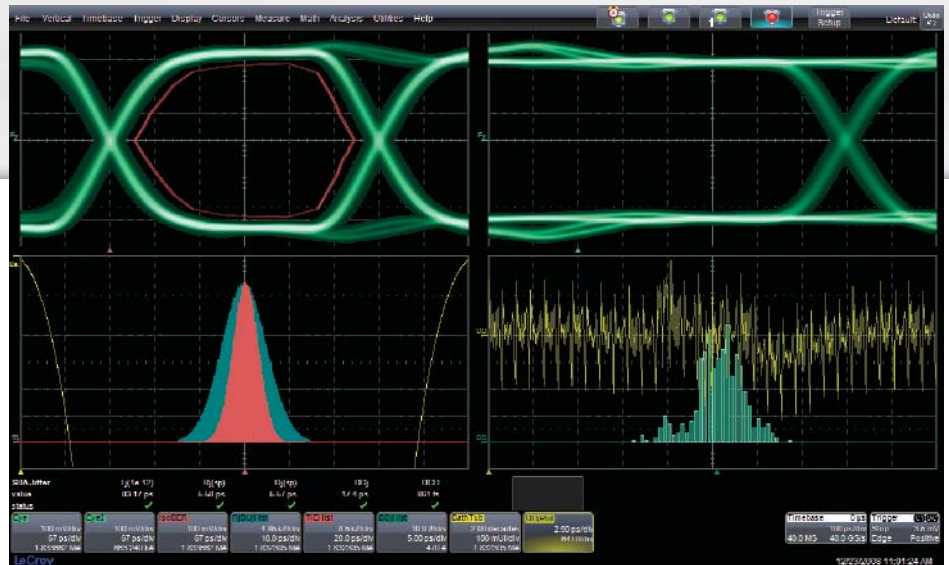

WaveMaster 8 Zi excels at performing complex calculations on long waveforms, enabling users to gain waveform insight with confidence. Here, a 40 Mpts PCIe Gen1 waveform acquisition is acquired and fully analyzed in a matter of seconds—nearly 100x faster than competitive oscilloscopes.

complex WaveShape Analysis are all easily handled at the same time. No time is lost waiting for one operation to end or the next one to begin. Unlike competitive oscilloscopes that become painfully slow to respond when long memory is applied. Bottom line: oscilloscopes no longer need to carry a penalty for operating with long memory.

Fast Off-Line Data Transfer

When the application calls for post-processing data off-line, an optional LeCroy Serial Interface Bus (LSIB)

high-speed 325 MB/s option provides data transfer 20–100x faster than any other test instrument.

LXI Class C Compliance

WaveMaster 8 Zi is Class C compliant with the LXI standard, the latest industry standard for Ethernet remote control operation. WaveMaster 8 Zi supports standard LXI features such as a LAN interface, VXI11 Discovery, a web server and IVI-C & IVI-COM drivers. The LXI interface allows engineers to build powerful, web-enabled test systems in less time.

Optimized for Long Memory

X-Stream II essentially has no analysis memory length restrictions, regardless of analysis type, since the variable waveform segment length can always be limited to a size that can fit in CPU cache memory. Other oscilloscopes with conventional architectures cannot make this claim, and often have limitations on analysis memory of 5–20% the length of their acquisition memory under the best conditions.

Optimized for Responsiveness

By dynamically allocating buffers to maximize memory availability, the WaveMaster 8 Zi Series embodies the fastest front panel responsiveness. A built-in processing abort makes front panel control changes instant by stopping the current process and allowing new waveforms to be positioned or zoomed—all without a lengthy recalculation. Meanwhile, waveform previewing shows interim calculation results.

MOST COMPLETE DEBUG SOLUTION FROM 4–30 GHz

Quick Insight for Debug

Insight is the power or act of seeing into a situation. Start up problems on a new design require a combination of problem recognition, precise triggering for fast isolation of rare events, and comparison tools that help correlate timing of problems. The ability to capture megapoints of waveform information and intuitively analyze it to find anomalies shortens the time to debug. WaveMaster's TriggerScan, WaveScan and deep measurement toolbox maximize quick insight.



High bandwidth differential probes, single-ended active probes, current probes, high-voltage, and mixed signals all connect to the WaveMaster 8 Zi oscilloscope and give you a total system view.

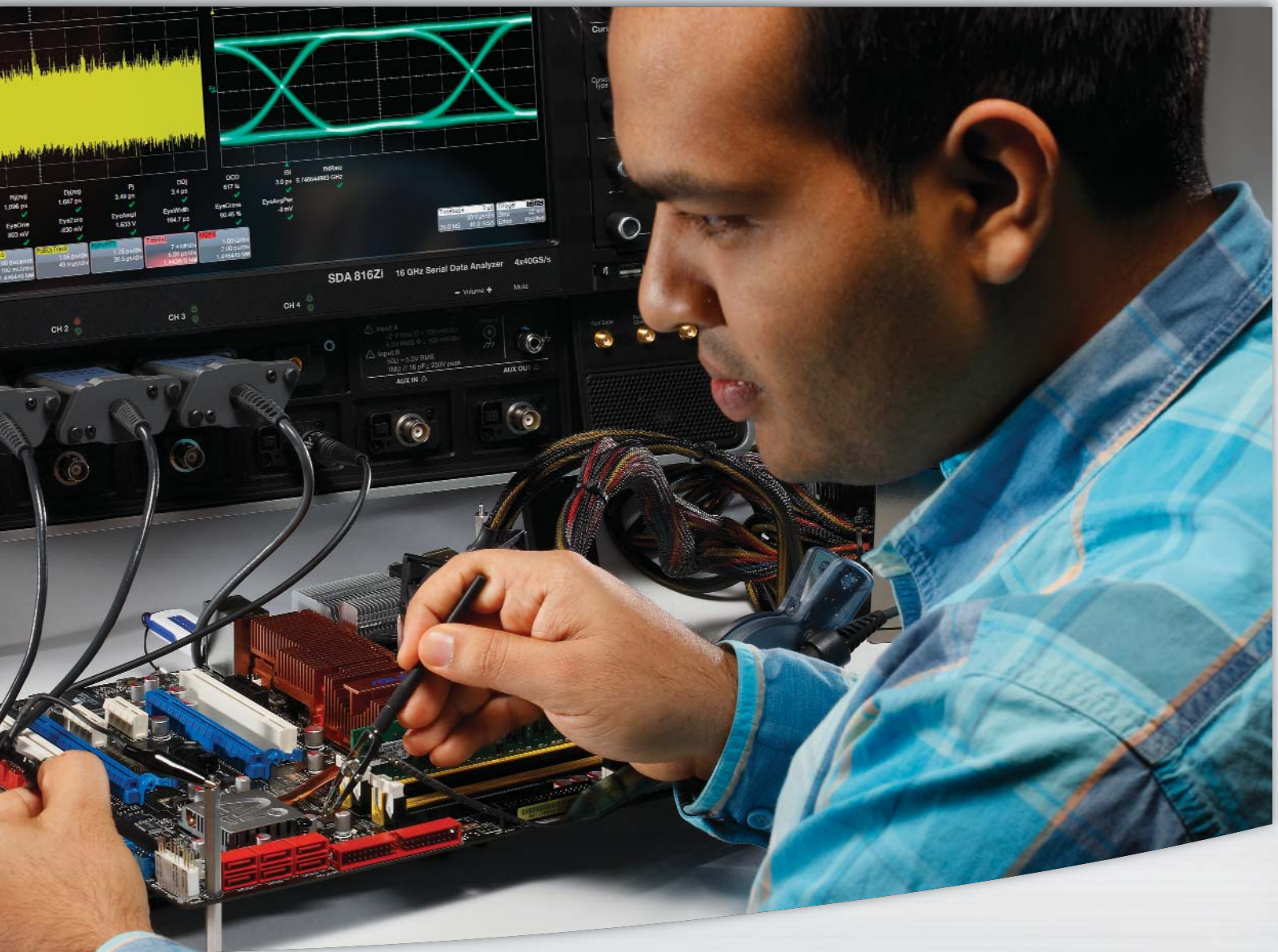

Freedom from Probing Limitations

WaveMaster 8 Zi excels in the way it offers general purpose utility never before seen in oscilloscopes from 4 to 30 GHz. All WaveMaster 8 Zi oscilloscopes contain selectable 50 Ω and 1 M Ω input capability and can be used with any LeCroy probe—passive or active—without requiring external adapters or power supplies. Use the two inputs per channel as a built-in switch matrix.

Complete System Debug

Understanding the relationships between different signals is vital to fast debug. Only WaveMaster 8 Zi combines the best of general purpose oscilloscopes (low-speed serial triggers and decoders, mixed signal capability, high impedance probing) with specialized 50 Ω inputs. This provides ability to 100% correlate high bandwidth signal activities or problems to low-speed events, such as low-speed serial data control words, power supply noise, or parallel data transmissions.

A New Way to Control an Oscilloscope

WaveMaster's fast and responsive front panel and touch screen user interface are well integrated so you can easily choose and setup your vertical, horizontal trigger and measurements. Zoom and scroll through a long waveform signal, control the oscilloscope with the detachable front panel right next to the circuit being probed.

QUICK INSIGHT: TRIGGER ON THE PROBLEM

More Triggers Isolate More Problems More Effectively

A powerful combination of a 15 GHz Edge trigger, 10 different SMART triggers, and Cascade™ triggering allow you to isolate the problem quickly and begin to focus on the cause. Some SMART triggers allow triggering on pulse widths or features as small as 200 ps. Cascade triggering enables any three triggers to be combined in an A then B then C cascaded condition. A high-speed serial trigger enables triggering on up to 3.125 Gb/s serial patterns of up to 80-bits in length. Built-in hardware clock recovery is also included.

A full range of serial triggers (I²C, SPI, UART, RS-232, CAN, LIN, FlexRay) are available, providing capability to isolate events related to serial peripheral bus traffic. Most serial triggers contain powerful conditional DATA triggering to allow inclusion or exclusion of entire ranges of data values, which expedites understanding of how a range of serial bus traffic DATA values interact with other signals.

TriggerScan™

TriggerScan uses high-speed hardware triggering capability with persistence displays to capture only the signals of interest and provide answers up to 100x faster than other methods. Traditional fast display update modes work best on frequent events occurring on slow edge rates while TriggerScan deploys trigger hardware to find infrequent events on fast edge rates. A built-in automated Trigger Trainer analyzes the waveforms, identifies normal behavior, and then sets up a large set of rare event smart trigger setups that target abnormal behavior. The trainer 'learns' trigger setups to identify faulty operation based on slew rates, periods, amplitudes, etc. outside of a range and then applies them sequentially. It then rapidly sequences through each individual trigger with a user-defined dwell time, and captures and displays any anomalous signals that meet the trigger conditions.

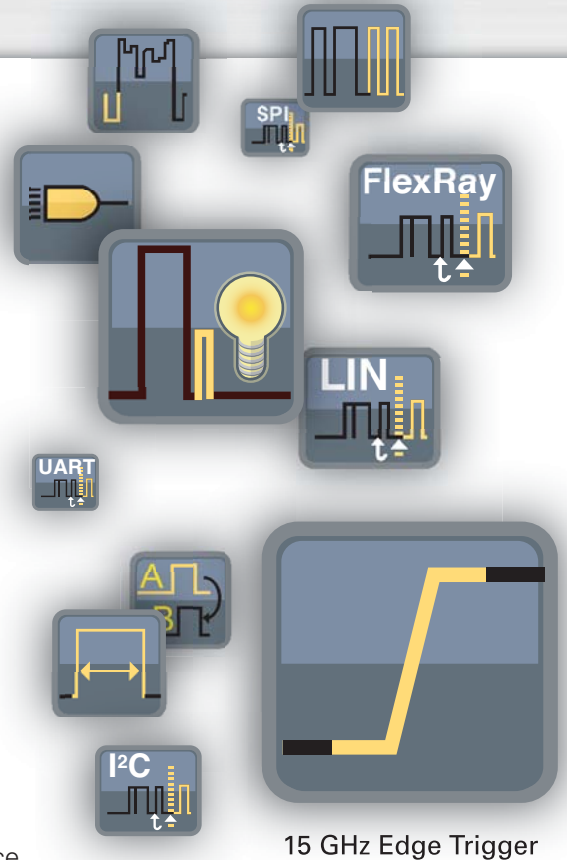

15 GHz Edge Trigger



A 1 in a billion rare event seems fast but is only 5 seconds of circuit operation on a 200 MHz clock. TriggerScan finds the rare event in 4 minutes while an oscilloscope with 400,000 waveforms/second capture rate misses 99.8% of the signals and could spend nearly 42 minutes to find the error.

QUICK INSIGHT: SEARCH AND SCAN TO UNDERSTAND

WaveScan™ Advanced Search and Analysis Finds Problems that Triggers Won't Find

The best trigger won't find all unusual events—a more powerful capability is sometimes needed. WaveScan provides the ability to locate unusual events in a single capture (i.e., capture and search) or “scan” for an event in many acquisitions over a long period of time. Select from more than 20 search modes (frequency, rise time, runt, duty cycle, etc.), apply a search condition and begin scanning. When an event is found, WaveScan highlights the error on screen and displays a table listing the errors. Simply click on an event in the table and go right to the anomaly. The X-Stream II processing architecture quickly ‘scans’ millions of events much faster than any other oscilloscope. Individual events can be compared and contrasted using ScanHisto and ScanOverlay features. These tools simplify the understanding of how errors correlate across input channels thus enabling faster debug.

Fully Integrated Mixed Signal Oscilloscope (4+36) Option

Add Mixed Signal Oscilloscope (MSO) operation using the MS Series mixed signal options. These convenient add-ons connect to the LeCroy LBUS and quickly and simply provide capability to acquire up to 36 digital lines time-correlated with analog waveforms. No time is wasted in trying to learn how to connect, synchronize or operate a complicated logic analyzer since the MSOs

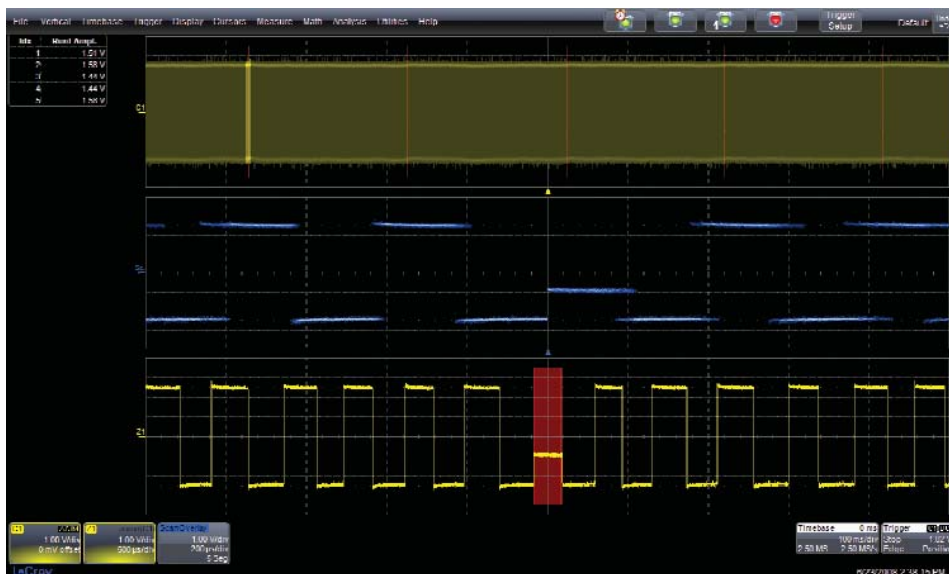

Find over 20 different types of features with WaveScan. Each feature is highlighted in the waveform and listed in a table. From the Scan Table jump directly to any anomaly and overlay for characterization.

Serial Decode—A Whole New Meaning to Insight

Advanced software algorithms deconstruct serial data waveforms into binary, hex, or ASCII protocol information and then overlay the decoded data on the waveform. Each section of the protocol is uniquely color-coded to make it easy to understand. The decode operation is fast—even with long acquisitions. Turn your oscilloscope into a

protocol analyzer with the Table Display of protocol information. Customize the table, or export table data to an Excel file. Select a table entry and automatically zoom for detail. Search for specific address or data values in the acquisition. Supported serial standards are 8b/10b, PCIe, PCIe 2.0, SAS, SATA, XAUI, I²C, SPI CAN, LIN, UART-RS-232, and FlexRay.



MSO options add capability to incorporate both analog and digital signals into a 4+36 pattern trigger for useful debugging in mixed signal designs.

DEEP INSIGHT TO CLARIFY COMPLEX SIGNALS

All Oscilloscope Tools are not Created Equal

WaveMaster 8 Zi has the deepest toolbox of any oscilloscope, providing more measure, math, graphing, statistical, and other tools, and more ways to leverage the tools to get the answer faster. While many other oscilloscopes provide similar looking tools, LeCroy allows the most flexibility in applying the tools to any waveform—whether it be a math or graphing function, memory trace, FFT, or parameters. Tools can be chained together to create unique views and understanding. All tools supplied with optional application packages are always integrated into the general purpose oscilloscope.

More Ways to Analyze

Convert time-domain information into statistical, parameter, or frequency domain. Use the oscilloscope as a spectrum analyzer for detailed frequency analysis (WM8Zi-SPECTRUM option). Implement Finite or Infinite Impulse Response (FIR or IIR) filters to eliminate undesired spectral components and enhance your ability to examine important waveform components (WM8Zi-DFP2 option).

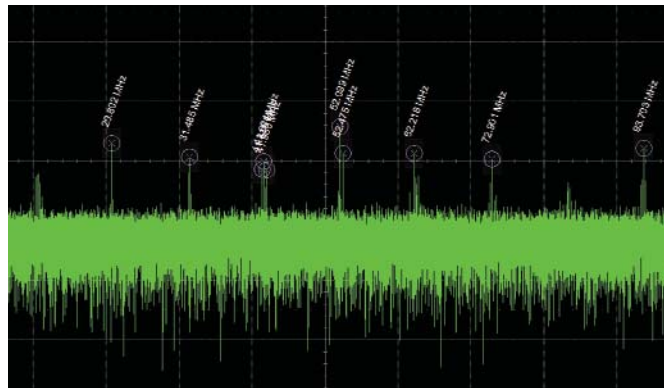

X-Stream II fast throughput streaming architecture makes difficult analysis and deep insight possible. Above, an FFT is applied to a 50 Mpts waveform to determine root cause failure. The high frequency resolution this provides enables deep insight into signal pathologies.

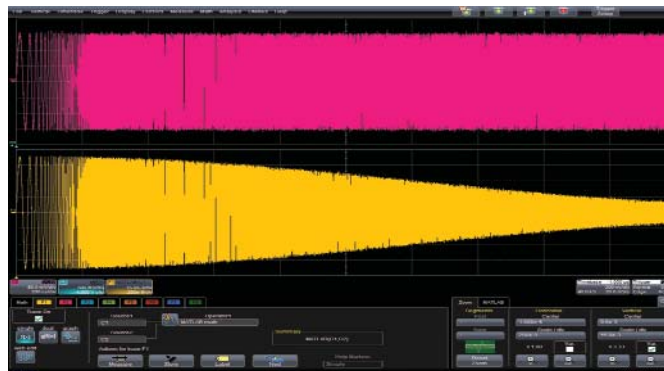

XDEV allows MATLAB® script to apply a customized filter and return the waveform to the scope display. Continue further analysis with the advanced toolbox in the oscilloscope.

More Ways to Create

Only LeCroy completely integrates third party programs into the scope's processing stream by allowing you to create and deploy a new measurement or math algorithm directly into the oscilloscope environment and display the result on the oscilloscope in real-time! There is no need to run a separate program, or ever leave the oscilloscope window. With the WM8Zi-XDEV Advanced Customization package, you can extend your

WaveMaster 8 Zi to include your most unique algorithms using FastWave port based on C/C++, and other programs (MATLAB, Excel, Jscript (JAVA), and Visual Basic). The code is entered in real time using the oscilloscope menus, which allows the built-in debugger to provide immediate feedback. The resulting measurement or math waveform is then returned to the display, allowing further analysis within the oscilloscope.

DISPLAY OPTIMIZED FOR ANALYSIS

More Ways to Understand

Use the processing web to set up advanced math operations. Apply multiple operators and process large amounts of data simultaneously to achieve the deepest of insights. Overlay color-coded protocol decodes to serial datastreams for fast understanding.

Track Views

Track in WaveMaster 8 Zi (WM8Zi-JTA2 option) uses every instance of a measurement in an acquisition to create a plot of measurement values on the Y-axis and time on the X-axis. The result is a graphical display of a measurement change time-correlated to the original channel acquisition—perfect for intuitive understanding of behaviors in frequency modulated (FM) or pulse width modulated (PWM) circuits and jitter measurements, including modulation or spikes.



Capture 5 ms (100 Mpts) of low-speed and high-speed waveforms. Easily zoom, and validate timing relationships between signals.

Histograms

WaveMaster 8 Zi calculates over 750,000 measurements/second—5x faster than other oscilloscopes in its class. With this much data, it is essential to provide more than just a list of mean, min, max, sdev, etc. values. Histograms provide an intuitive way to graphically view the distribution of statistical data and quantify real insight into underlying problems.

Trend Views

Slowly sample at 1000 seconds/div to capture hours of slow-speed signal data and turn your oscilloscope into a strip chart Recorder. Using Trend views, plot measurement values of high-speed signals with slower speed signals, such as transducer or voltage values.

Data Transfer Speeds 25–100x Faster

LeCroy's Serial Interface Bus (LSIB) option enables direct connection to the PCI Express® x4 high-speed data bus in the oscilloscope to enable data transfer rates up to 325 MB/s. All that is required is installation of an optional LSIB card in the oscilloscope and the corresponding host board (card) for desktop (laptop) PC in the remote computer. Data transfer is easily enabled through a supplied application program interface (API).

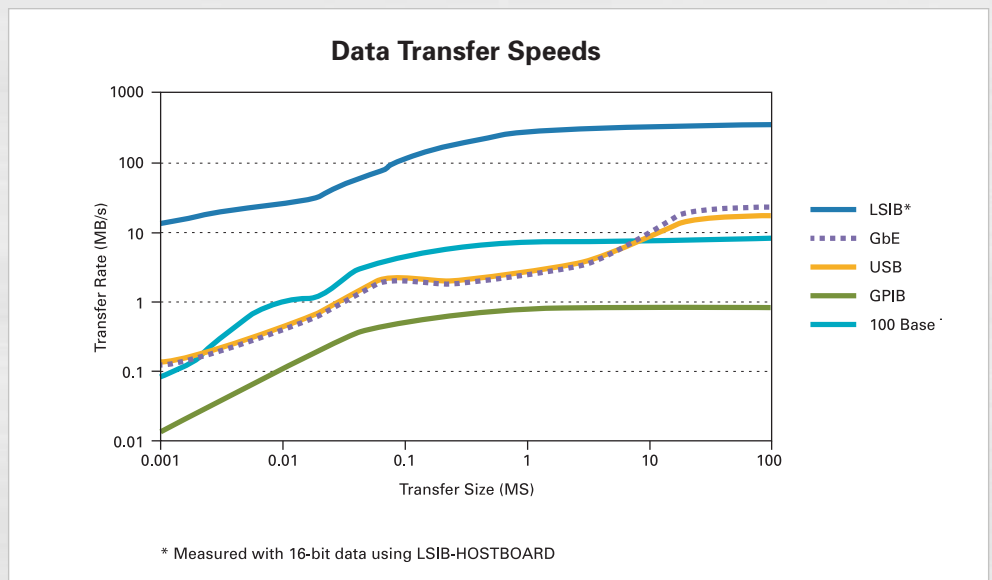

TRIPLE THE DISPLAY AREA, ACHIEVE GREATER INSIGHT

TRIPLE THE DISPLAY AREA, ACHIEVE GREATER INSIGHT

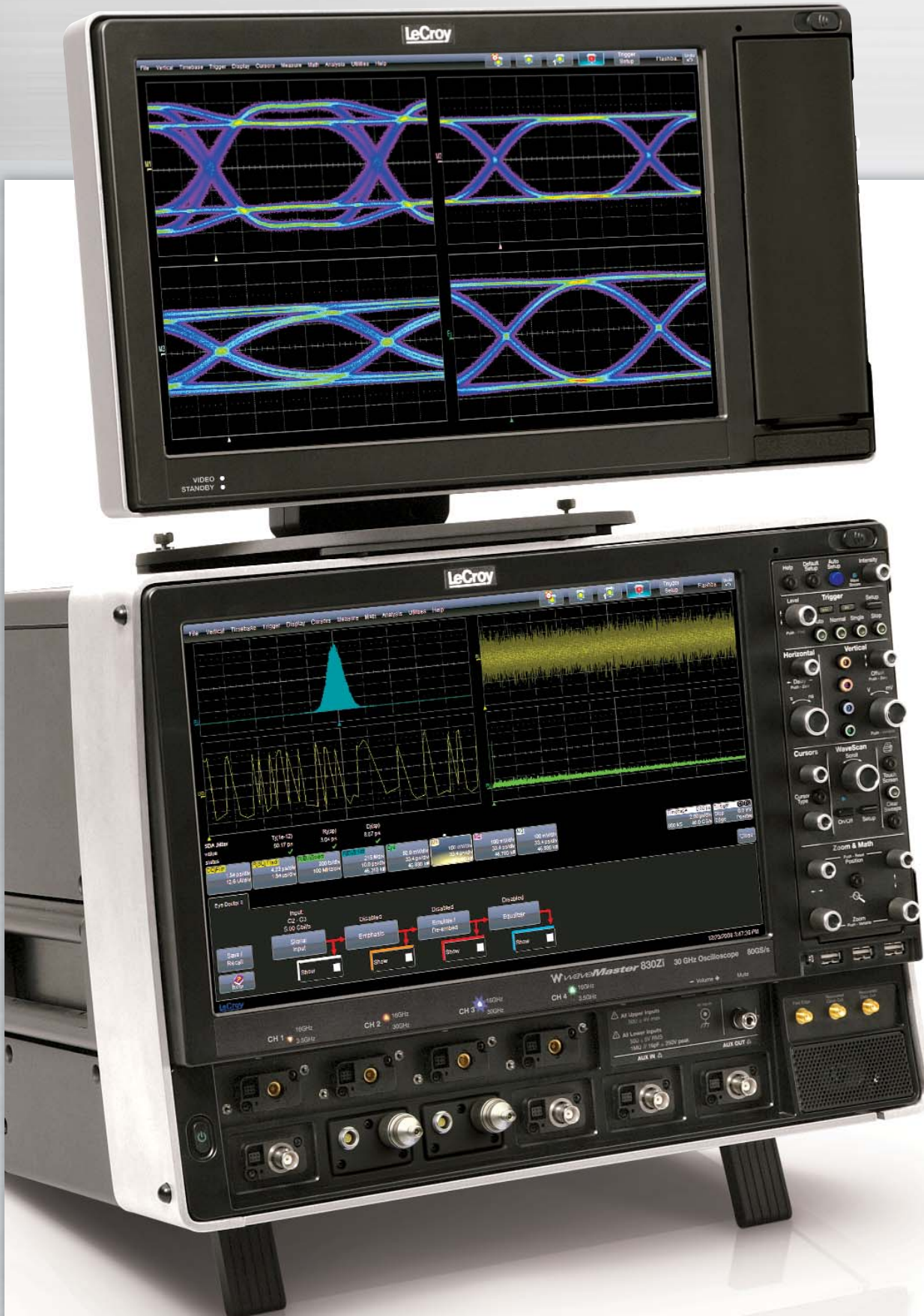

The integrated second touchscreen display is used to display simultaneous view of serial data jitter using eye diagrams for total jitter and jitter decomposition analysis views. Thus, it is possible for a design engineer to quickly understand system behavior and root cause of high serial data jitter.

INCREASE YOUR PRODUCTIVITY



The 8 inputs can essentially be multiplexed into four channels to minimize probe reconnections or to simplify automated testing.

Second Display Quickens Time to Insight

The optional integrated second 15.3" WXGA touchscreen display offers creative new ways to display multiple waveforms, third party software, the graphical LeCroy Processing Web, or on-line Help. Grids can be split between displays, and waveforms can easily move from the upper to lower display to show more useful analysis information and quicken the time to insight. With the second display, the total grid display area is three times that of the 12.1" displays commonly used on other oscilloscopes in this class.

Input Full Range of High Bandwidth and Low Bandwidth Signals

High bandwidth oscilloscopes require special connectors, such as SMA or K-type/2.92 mm. Other oscilloscope suppliers provide these and no other

types, which limits high bandwidth oscilloscopes to specialized measurement of high bandwidth signals only. However, LeCroy also provides inputs with BNC connectors and 1 M Ω input impedance for use with standard passive probes. These same connectors are also usable with LeCroy's full line of high impedance active single-ended probes, low bandwidth differential probes, current probes, high voltage probes, etc. Thus, a customer can input the full range of high bandwidth (e.g. serial data) and low bandwidth (e.g. power supply, low-speed serial data I²C, SPI, etc.) signals into any bandwidth WaveMaster 8 Zi oscilloscope, eliminating the need for costly special adapters or auxiliary probe power supplies, or additional general purpose oscilloscopes, and allowing the widest range of signal types to be input into the oscilloscope.



The front panel on the WaveMaster 8 Zi is removable. This allows you to put the front panel next to the circuit under test, or locate it remotely from the test area. Simply connect a standard USB 2.0 cable of any length to the front panel and untether yourself from standard oscilloscope constraints.

APPLICATION SPECIFIC SOLUTIONS

In addition to the general purpose WaveShape Analysis tools, application specific solutions are available for Serial Data Compliance, Embedded Design, Digital Design, and Automotive. These packages extend the LeCroy standard measurement and analysis capabilities and expand your oscilloscope's utility as your needs change.

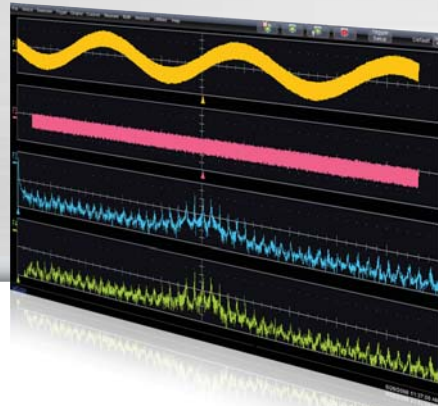

Digital Filter Software Package (WM8Zi-DFP2)

DFP2 lets you implement Finite or Infinite Impulse Response filters to eliminate undesired spectral components, such as noise, and enhances your ability to examine important signal components. You can choose from a standard set of FIR or IIR filters. You can also design your own filters.



Spectrum Analyzer Analysis Package (WM8Zi-SPECTRUM)

SPECTRUM converts the controls of your oscilloscope to those of a spectrum analyzer. Adjust the frequency span, resolution and center frequency. Apply filtering to your signal and watch the frequency signature change in real time. A unique peak search labels spectral components and presents frequency and level in a table. Touch any line to move to that peak.

Serial Data Trigger and Decode

Quickly and easily isolate serial data events on your embedded controller for better understanding and faster debug. Trigger and decode options provide powerful conditional triggering, intuitive color-coded decode overlays, and a table summary with search and zoom capabilities. Decode solutions are available for PCIe, PCIe 2.0, SAS, SATA, XAUI, generic 8b/10b, or user-defined 8b/10b format. Trigger and decode solutions are available for I²C, SPI, UART/RS-232, CAN, LIN, and FlexRay.

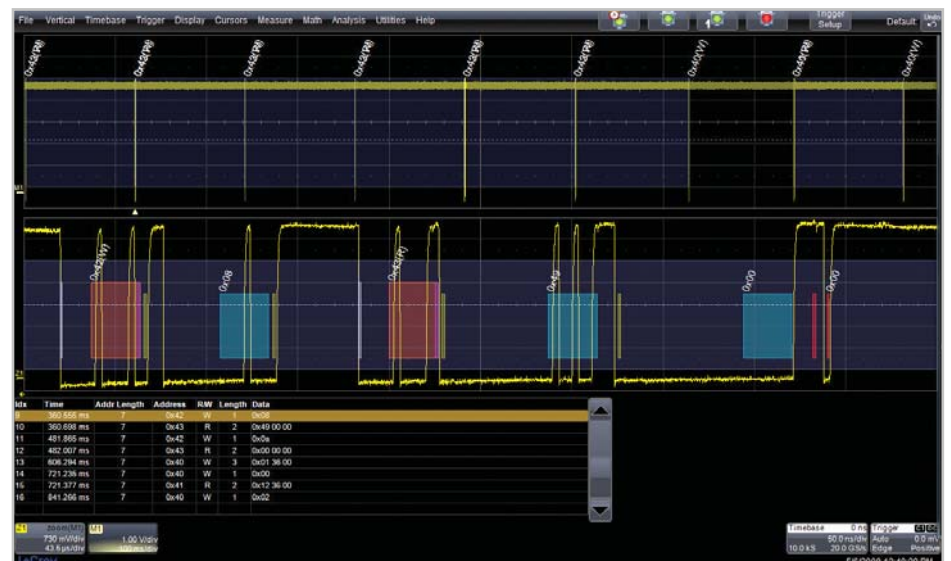

I²C decoding package with intuitive color decoding and table view allows quick location of 0x42 address.

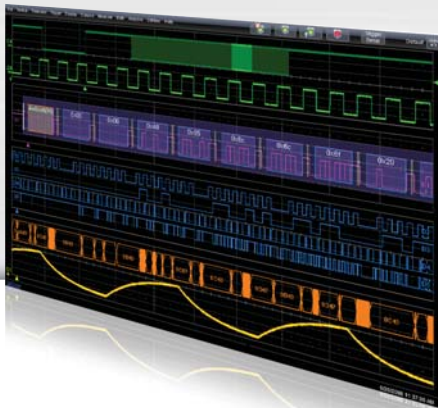

Mixed Signal Oscilloscope Option (MS-250/MS-500)

The Mixed Signal options allow the WaveMaster 8 Zi to convert to a mixed signal oscilloscope with up to 36 digital channels. Channels are sampled at 2 GS/s (500 MHz max clock speed) up to 50 Mpts/Ch. Having up to 36 digital inputs time-synchronized with four analog channels extends the oscilloscope's use to provide a total system view.

Serial Data Compliance Packages

QualiPHY serial data compliance packages provide easy to use step-by-step instructions for a broad set of serial data standards, such as Ethernet, USB 2.0, PCI Express, SATA, HDMI, DisplayPort and UWB (Ultra-Wideband). With fast automated performance, illustrated instructions and comprehensive reporting capability, QualiPHY packages are the best solution for compliance testing. For standards not supported with QualiPHY compliance packages, jitter and eye diagram test toolsets are generally included in the SDA 8 Zi models.

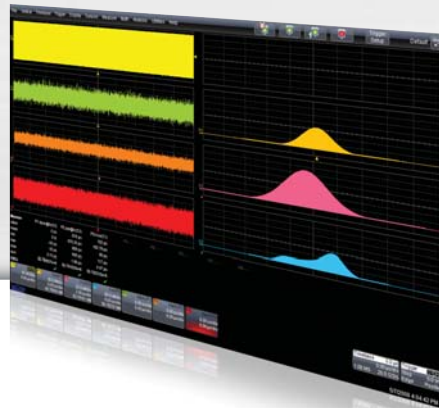

Jitter and Timing Analysis Package (WM8Zi-JTA2)

JTA2 Specialized timing parameters measure period, cycle-cycle, half period, width, etc. jitter on a variety of signals. Use the three views of jitter (statistical, time, and frequency) to understand root cause and to debug problems. Histograms provide understanding of statistical distributions. Tracks provide a means to show time-correlated peaks of jitter, and compare to other signals. FFTs provide the ability to debug root causes of high in-circuit jitter.

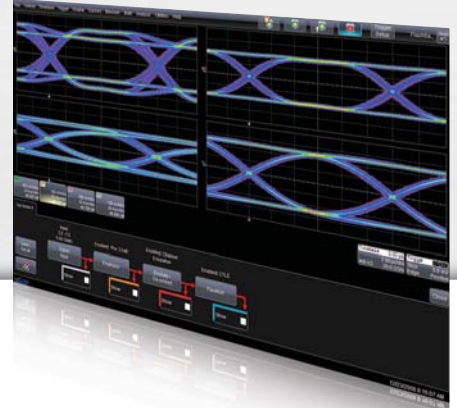

Eye Doctor II – Advanced Signal Integrity Tools (WM8Zi-EYEDRII)

Eye Doctor II Signal Integrity Tools provide the ability to add precision to signal integrity measurements by allowing subtraction of fixture effects and emulation of emphasis, serial data channels and receiver Decision Feedback Equalization (DFE) Forward Feedback Equalization (FFE) and Continuous Time Linear Equalization (CTLE) effects while at the same time maintaining fast scope update speed on unlimited record lengths.

Using Eye Doctor II, an engineer can re-capture design margin that was previously sacrificed to the test fixtures and cables and better understand actual circuit performance.

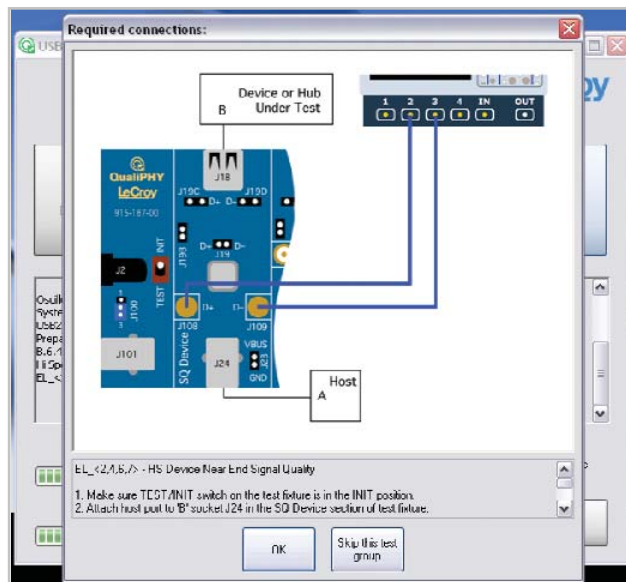

SDA 8 Zi SERIES

Key Features

- LeCroy's unique summary view displays the Eye Pattern, TIE, Bathtub Curve and Jitter Histogram all on the screen at the same time
- Create Eye Patterns utilizing the full memory for maximum statistical significance
- 100 times faster Eye Diagram creation
- Gain insight with IsoBER and Mask Violation Locator tools
- Complete Data Dependent Jitter (DDj) decomposition with histograms, plots, and Inter-Symbol Interference (ISI) parameters and plots
- Complete Random Jitter (Rj) + Bounded Uncorrelated Jitter (BUj) views include Histogram, Spectrum and Track
- Complete Period Jitter (Pj) analysis with a time domain view of Pj (Pj Inverse FFT)
- Two simultaneously calculated jitter decomposition models provide maximum confidence and correlation
- Trigger on 80-bit patterns at up to 3.125 Gb/s using the Serial Trigger
- Decode 8b/10b data on up to 4 lanes simultaneously
- Configure the software PLL for any standard or custom requirement



A Total Solution for Serial Data Analysis

Unleash the power of serial data analysis for understanding and characterizing your design, proving compliance and understanding why a device or host fails compliance. The Quad Summary View of the SDA II software always shows the eye, TIE, bathtub curve and jitter histogram. No other Serial Data Analyzer lets you see the simultaneous interaction and real-time changes in all four views. The X-Stream II Architecture provides fast updates and the fastest eye interpretation. Combined with up to 512 Mpts record lengths and more complete jitter decomposition tools, SDA II provides the fastest and most complete understanding of why serial data fails a compliance test.

Whether debugging eye pattern or other compliance test failures, the SDA 8 Zi Series rapidly isolates the source of the problem in your design. Advanced jitter decomposition

methodologies and tools provide more information about root cause. Eye Doctor II Advanced Signal Integrity Tools provide more measurement precision through the use of de-embedding and emulation of cables, fixtures, emphasis, serial data channels, and receivers. All jitter decomposition analysis functions can be zoomed and time correlated to specific serial data or other events, making root cause determination faster and easier.

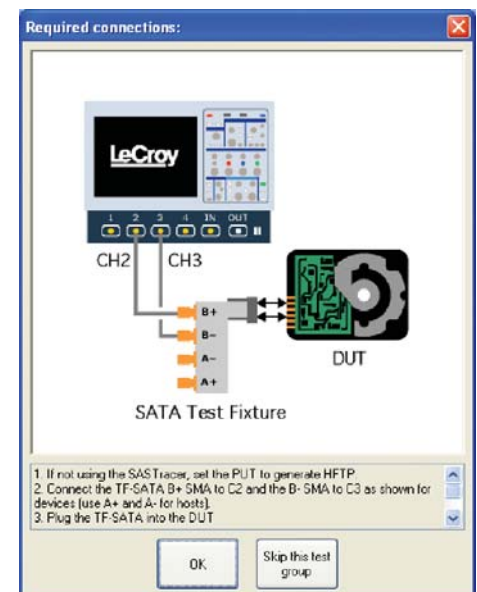

A TOTAL SOLUTION FOR SERIAL DATA ANALYSIS



Data Rate Configuration Chart

Automated Compliance Testing

The QualiPHY compliance test suite provides step-by-step instructions for testing compliance on a wide array of serial data standards. The process is simplified with fast, automated test operations, illustrated instructions, connection diagrams, and stop on fail feature. Complete test reporting is also provided.

Standard	Bit Rate	Minimum Bandwidth	Recommended Oscilloscope
Serial Rapid I/O ExpressCard	0.5 Gb/s	13 GHz	SDA 813Zi or Above
InfiniBand	2.5 Gb/s	8 GHz	SDA 808Zi or Above
PCI Express Rev. 2.0	2.5 Gb/s	8 GHz	SDA 808Zi or Above
Serial Rapid I/O	2.5 Gb/s	8 GHz	SDA 808Zi or Above
DisplayPort 1.1	2.7 Gb/s	8 GHz	SDA 808Zi or Above
HyperTransport 2.0	2.8 Gb/s	7 GHz	SDA 808Zi or Above
SAS G2	3 Gb/s	8 GHz	SDA 808Zi or Above
SATA 1.0 Gen2i	3 Gb/s	8 GHz	SDA 808Zi or Above
SATA 1.0 Gen2m	3 Gb/s	8 GHz	SDA 808Zi or Above
SATA 1.0 Gen2x	3 Gb/s	8 GHz	SDA 808Zi or Above
Serial Rapid I/O	3.125 Gb/s	8 GHz	SDA 808Zi or Above
SGMII	3.125 Gb/s	8 GHz	SDA 808Zi or Above
XAUI	3.125 Gb/s	8 GHz	SDA 808Zi or Above
FB-DIMM	3.2 Gb/s	8 GHz	SDA 808Zi or Above
FireWire	3.2 Gb/s	8 GHz	SDA 808Zi or Above
HDMI 1.3a/b/c	3.4 Gb/s	10 GHz	SDA 813Zi or Above
FB-DIMM	4 Gb/s	10 GHz	SDA 813Zi or Above
Fibre Channel 4GFC	4.25 Gb/s	13 GHz	SDA 813Zi or Above
Serial Rapid I/O	4.25 Gb/s	13 GHz	SDA 813Zi or Above
FB-DIMM	4.8 Gb/s	12 GHz	SDA 813Zi or Above
USB 3.0	5 Gb/s	12 GHz	SDA 813Zi or Above
InfiniBand	5 Gb/s	13 GHz	SDA 813Zi or Above
PCI Express Rev. 2.0	5 Gb/s	13 GHz	SDA 813Zi or Above
Serial Rapid I/O	5 Gb/s	13 GHz	SDA 813Zi or Above
HyperTransport 3.0	5.2 Gb/s	13 GHz	SDA 813Zi or Above
DisplayPort 1.2	5.4 Gb/s	16 GHz	SDA 816Zi or Above
GDDR5	6 Gb/s	16 GHz	SDA 816Zi or Above
SAS G3	6 Gb/s	16 GHz	SDA 816Zi or Above
SATA Gen3i	6 Gb/s	16 GHz	SDA 816Zi or Above
Serial Rapid I/O	6.25 Gb/s	16 GHz	SDA 816Zi or Above
FB-DIMM	6.4 Gb/s	16 GHz	SDA 816Zi or Above
HyperTransport 3.1	6.4 Gb/s	16 GHz	SDA 816Zi or Above
QPI (Quick Path Interconnect)	6.4 Gb/s	16 GHz	SDA 816Zi or Above
FB-DIMM	8 Gb/s	20 GHz	SDA 820Zi or Above
PCI Express Gen3	8 Gb/s	20 GHz	SDA 820Zi or Above
General	10 Gb/s	25 GHz	SDA 825Zi or Above
Serial Rapid I/O	10 Gb/s	25 GHz	SDA 825Zi or Above
General	12 Gb/s	30 GHz	SDA 830Zi

SDA II – ADVANCED TOOLS TO ISOLATE AND ANALYZE

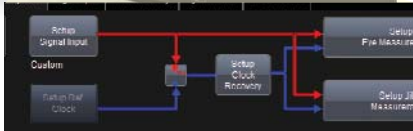
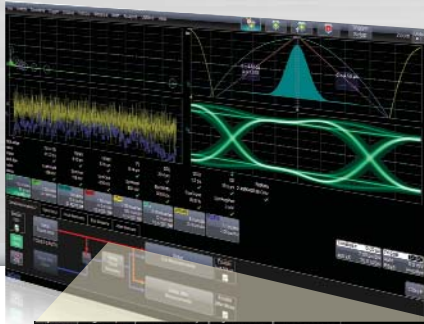

Flow Diagram User Interface

Eye and jitter analysis in the SDA 8 Zi begins with a simple, interactive flow diagram intuitively guides you through the setup of Eye Measurements, Jitter Measurements, or both at the same time.



Serial Trigger

The SDA 8 Zi Series comes standard with the 80-bit Pattern Trigger installed. The serial trigger operates up to 3.125 Gb/s and supports both 8b/10b and NRZ signals, and also includes a recovered clock and data output on the front of the oscilloscope.

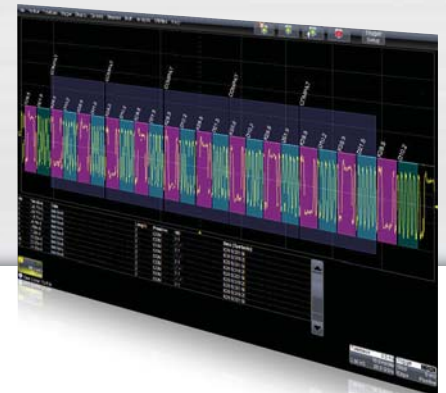

8b/10b Decoding

The LeCroy's 8b/10b serial decode option has powerful search capabilities enabling captured waveform searches for user-defined sequences of symbols. Multi-lane analysis decodes up to four simultaneously captured lanes. User selection is provided for PCIe, PCIe 2.0, SAS, SATA, XAUI, generic 8b/10b or user-defined 8b/10b protocols.

Jitter Spectrum

- The jitter spectrum plot allows viewing of any periodic jitter
- Peak annotation displays the frequencies directly on the spectrum
- The LeCroy spectrum plot allows viewing of DDj removal for maximum comprehension

Jitter Trend

- Time domain view of jitter shows transient jitter events that can be missed by viewing the histogram alone
- The jitter trend clearly shows any non-stationary jitter behavior

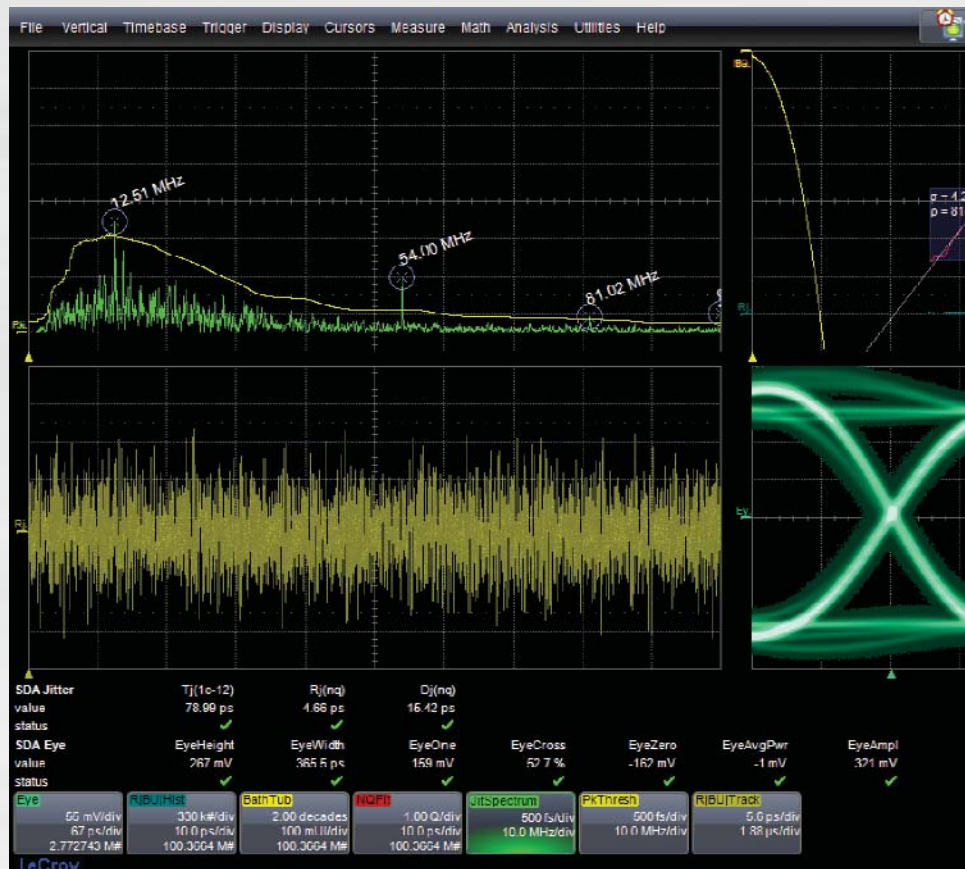

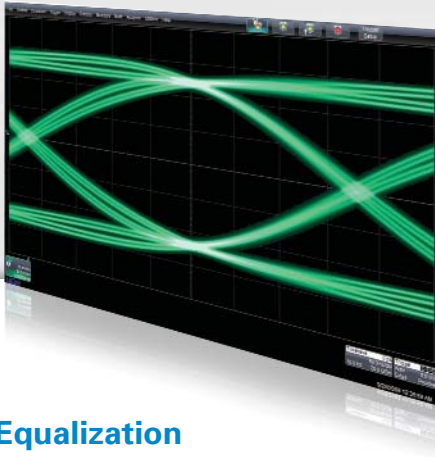

Equalization

The equalization feature removes the signal integrity effects created in systems that utilize equalization. Users can view the eye of a waveform as seen by a receiver that employs equalization.



ISI Plot

The ISI plot shows data-dependent jitter contributions to the eye pattern for the second-to-last bit of a bit length, set from 3 to 10. This plot measures data dependent jitter (DDJ) eliminating the need for a repeating bit pattern.



Before

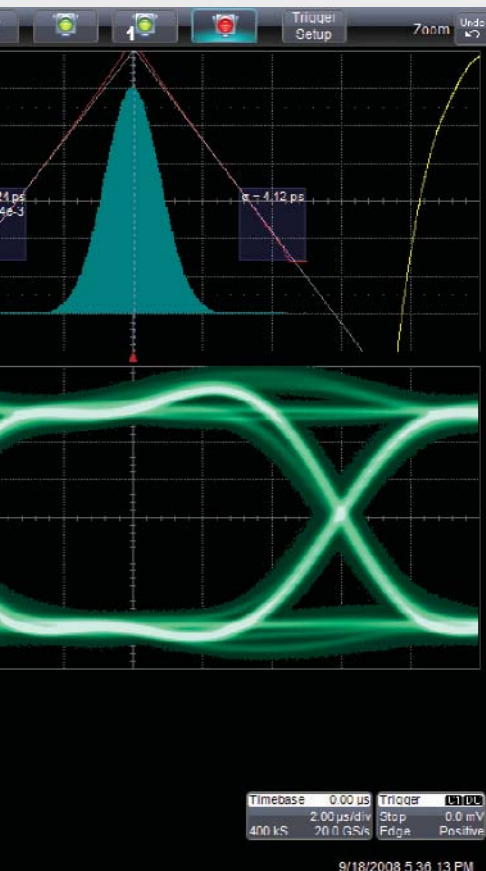

Histogram & Bathtub

- Measured jitter histogram clearly displays unusual jitter distributions like bi-modal or non-Gaussian tails. The raw data view shows possibly lost jitter behavior just by viewing the jitter decomposition
- This unprocessed display gives a high degree of confidence in the accuracy of the jitter decomposition and bathtub curve

Eye Patterns Show Mask Violations to the Bit

- Eye pattern measurement on up to 8 million consecutive bits captures transient jitter and noise events
- Consecutive bit eye pattern analysis allows for the measurement of the wave shapes of individual bits that violate the compliance mask (violation location)
- The fastest UI accumulation and very low measurement jitter (typically 1 ps rms)



After

Cable De-embedding

Even expensive, high-performance cabling can have an adverse effect on measurements and decrease margin from a design. Cable losses and slow rise times can lead to inter-symbol interference (ISI). The cable de-embedding feature removes these adverse effects providing more accurate measurements.

DDA 8 Zi SERIES

Key Features

- 16 or 25 GHz
- Zoom on multi-zoom on sectors
- One button access to read channel emulation and disk drive triggers
- Head equalization, channel Emulation, and SAM histograms
- Segmented memory for sector by sector parametric analysis
- Built-in PWxx, amplitude, pulse shape, and ACSN parametric measurements
- Customizable with MATLAB, Visual Basic, or Excel scripts
- 325 MB/s data transfer rate from oscilloscope to PC for offline analysis (optional)
- Full suite of SDA tools integrated for analysis of SAS/SATA drives
- 20 Mpts memory standard
- 8 dual integrated inputs of 50 Ω and 1 M Ω



A Total Solution for Disk Drive Analysis

Maximum Performance

LeCroy Disk Drive Analyzers (DDA) assist data storage design engineers by integrating tools that improve the time to market of new products and accelerate understanding and failure analysis on existing drives. LeCroy continues that tradition with the DDA 8 Zi Series equipped with its powerful Disk Drive Analysis toolset. Capture, view, and analyze the wave shape of high-speed, complex drive signals with speed and integrity. Data Storage applications are memory intensive as capturing multiple sectors or a complete track of data can be important in troubleshooting a design or characterizing media. The X-Stream II architecture enables fast and accurate measurements and analysis of disk drive signals. Memory can be extended to 256 Mpts/Ch using Option VL. DDA 8 Zi's offer

the convenience of selectable 50 Ω or 1 M Ω inputs. The standard 20 Mpts of waveform memory and 40 GS/s capture on four channels, means multiple drive sectors can be acquired at once.

Long Memory and Flexibility in Finding Problems

Acquire a head signal and then QuickZoom it from the front panel. The DDA copies and expands the drive signal automatically. Simply scroll horizontally and vertically to examine any sector. Multiple zooms let you view up to eight separate areas of the head signal; each zoom comes in a distinct color. Disk drive parameters let you characterize the pulse width variation or signal-to-noise ratio across a region. Failure Analysis engineers can store and recall golden waveforms and panel setups to compare problem drives with the known good drives.

A TOTAL SOLUTION FOR DISK DRIVE ANALYSIS

Analog-to-digital converters running at speeds of 40 GS/s ensure the right sensitivity to measure today's high-speed read channels. In every DDA, you can run your customer-developed scripts to view the captured signal with the filters matched to your channel and media. Custom user scripts can be created in MATLAB, Visual Basic, Excel or other formats.

Exceptional Trigger and Sequence Performance

The DDA's disk triggers allow you to set up a series of events in the signal that then cause a trigger. For example, qualify the signal on the index signal and then capture all the sectors of information on the track. As memory is increased in the DDA, more sectors can be captured, with up to 50 picosecond/

sample time resolution. Up to 15,000 sectors of data can be gathered with the DDA 8 Zi analyzers.

Cascade Triggering

Triggering allows up to two events to qualify a third event (arm on A event, then qualify on B event, then trigger on C event) for precise trigger control. For instance, this could be used to Arm when the Index signal goes high, qualify when the Read Gate signal goes high, then trigger on a Head signal.

Natural Graphical Interface

One press on the DDA menu takes you directly to the Disk Drive Analyzer features. The familiar controls on the front panel, coupled with a natural, context-sensitive graphical user-interface, react quickly to your commands. Functionality is exactly where you expect it to be.

The DDA 8 Zi provides one button access to all the tools needed to accurately debug and analyze disk drive operation.

The DDA 8 Zi Features:

- 28 Custom Parameters
- Specific Drive Triggers
 - Sector
 - Servo Gate
 - Read Gate Trigger
- Advanced Drive Analysis Tools
 - Head Filter Equalizer Emulation
 - Channel Emulation
 - SAM Histograms
 - Plot of SAM Values
 - Analog Compare

Simultaneously connecting low-speed signals, like index and servo gate, and high-speed signals, like read channels has never been easier. With integrated 50 Ω and 1 M Ω inputs on all models, there is no longer a need for expensive adapters.



HIGH BANDWIDTH PROBING SOLUTIONS

The DA18000 Differential Amplifier

The DA18000 Differential Amplifier is a very high bandwidth DC coupled differential amplifier with a true 100 Ω balanced input. It features high common mode rejection and low noise. The amplifier has unity gain, to maximize the signal to noise performance when used with the lower amplitude signal voltages common in higher data rate systems.

The DA18000 is supplied with a short pair of input cables which are matched to an electrical propagation length of 2.5 ps. Use of the DA18000 with these cables eliminates the need to deskew and calibrate input channels for differential match, a problem encountered when acquiring

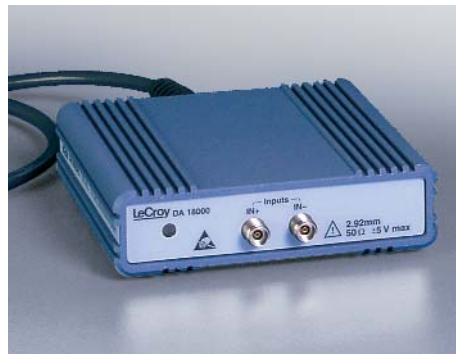

differential signals with two oscilloscope channels connected with long cables.

The DA18000 differential amplifier utilizes third generation digital response equalization, the same calibration method used in LeCroy's award winning high bandwidth probes. This provides the most accurate magnitude and phase response, assuring the high fidelity eye pattern measurements.

Specification	Value
Input Configuration	True Differential, 100 Ω Balanced
Input Connector	2.92 mm
Frequency Response, System	DC–18 GHz, Typical
Rise time, 20%–80%, System	< 24 ps, Typical
Rise time, 20%–80%, Probe Only	< 19 ps
Voltage Gain	X 1
Voltage Gain Accuracy	2%, (20–30 $^{\circ}$ C)
Max. Offset Voltage, RTI	< 5 mV
Noise, System	1 mV _{rms} , Typical
Maximum Input – Differential with $\div 2$ Attenuators	± 400 mV (800 mV _{p-p}) ± 800 mV (1.6 V _{p-p})
Maximum Input – Common Mode with $\div 2$ Attenuators	± 10 V 7 V _{rms}
Common Mode Resistance, DC	25 k Ω

Included with the DA18000:

Electrically matched input cables (2), $\div 2$ precision attenuators (2), ESD dissipating wrist strap, Instruction Manual, certificate of traceable calibration, soft accessory case.

D13000PS/D11000PS Differential Probe System

The D13000PS/D11000PS extends the full signal acquisition performance of WaveMaster 8 Zi to the probe tips. With 13/11 GHz system bandwidth, the probe enables direct measurement of high-speed serial data streams up to 6.25 Gb/s.

The D13000PS/D11000PS provides unprecedented waveform fidelity, even with signals at higher serial data rates. Each probe utilizes third generation response compensation calibration, the most advanced in use today, to provide optimal system response.

The D13000PS/D11000PS provides both direct Solder-In and cabled SMA-connector interconnect lead assemblies. The D13000PS also provides SMP cables for additional cabling options. Each interconnect lead comes with a dedicated probe amplifier module that has calibration data optimized for the respective lead. This eliminates the performance compromise of using a single calibration for multiple lead types.



OTHER PROBING SOLUTIONS

All probes described below may be used with any WaveMaster 8 Zi oscilloscope. In addition, passive probes (not shown here) may also be used.

WaveLink Differential Probes

- 3 and 6 GHz models
- Excellent noise performance
- ± 4 V offset
- ± 3 V common mode control
- Solder-In, Browser, Quick-Connect, and Square Pin tip



ADP305, ADP300

- 20 MHz and 100 MHz bandwidth
- 1,000 V_{rms} common mode voltage
- 1,400 V_{peak} differential voltage
- EN 61010 CAT III
- 80 dB CMRR at 50/60 Hz
- LeCroy ProBus system



CP030 and CP031

- 30 A_{rms} continuous current
- 50 or 100 MHz bandwidth
- Measure pulses up to 50 A_{peak}
- Small form factor accommodates large conductors with small jaw size
- LeCroy ProBus system



AP031

- Lowest priced differential probe
- 15 MHz bandwidth
- 700 V maximum input voltage
- Works with any 1 M Ω input oscilloscope



ZS Series High Impedance Active Probes

- 1 GHz (ZS1000) and 1.5 GHz (ZS1500) bandwidths
- High Impedance (0.9 pF, 1 M Ω)
- Extensive standard and available probe tip and ground connection accessories
- ± 12 Vdc offset (ZS1500)
- LeCroy ProBus system



PPE1.2KV, PPE2KV, PPE4KV, PPE5KV, PPE6KV, PPE20KV

- Suitable for safe, accurate high-voltage measurements
- 1.2 kV to 20 kV
- Works with any 1 M Ω input oscilloscope



AP033 and AP034

- 500 MHz and 1 GHz bandwidth
- 10,000:1 CMRR
- Wide dynamic range, low noise
- LeCroy ProBus System



SPECIFICATIONS

Vertical System	WaveMaster 804Zi (SDA)	WaveMaster 806Zi (SDA)	WaveMaster 808Zi (SDA)	WaveMaster 813Zi (SDA)	WaveMaster 816Zi (SDA,DDA)
Analog (ProLink Input) Bandwidth @ 50 Ω (-3 dB)	4 GHz (≥ 10 mV/div)	6 GHz (≥ 10 mV/div)	8 GHz (≥ 10 mV/div)	13 GHz (≥ 10 mV/div)	16 GHz (≥ 10 mV/div)
Analog (ProBus Input) Bandwidth @ 50 Ω (-3 dB)	3.5 GHz (≥ 10 mV/div)	3.5 GHz (≥ 10 mV/div)	3.5 GHz (≥ 10 mV/div)	3.5 GHz (≥ 10 mV/div)	3.5 GHz (≥ 10 mV/div)
Analog (ProBus Input) Bandwidth @ 1 M Ω (-3 dB)	500 MHz (typical, ≥ 2 mV/div)				
Rise Time (typical, 10–90%, 50 Ω)	94 ps	63 ps	50 ps	33 ps	28 ps
Rise Time (typical, 20–80%, 50 Ω)	71 ps	47 ps	37 ps	25 ps	21 ps
Input Channels	4				
Bandwidth Limiters	20 MHz, 200 MHz, 1 GHz	20 MHz, 200 MHz, 1 GHz, 4 GHz	20 MHz, 200 MHz, 1 GHz, 4 GHz, 6 GHz	20 MHz, 200 MHz, 1 GHz, 4 GHz, 6 GHz, 8 GHz	20 MHz, 200 MHz, 1 GHz, 4 GHz, 6 GHz, 8 GHz, 13 GHz
Input Impedance	50 Ω $\pm 2\%$ or 1 M Ω 16 pF, 10 M Ω 11 pF with supplied probe				
Input Coupling	ProLink Inputs: 50 Ω : DC, GND ProBus Inputs: 1 M Ω : AC, DC, GND 50 Ω : DC, GND				
Maximum Input Voltage	50 Ω (ProLink): ± 2 V max. 50 Ω (ProBus): ± 5 V max., 3.5 V _{rms} 1 M Ω (ProBus): 250 V max. (peak AC: < 10 kHz + DC)				
Vertical Resolution	8 bits up to 11 bits with enhanced resolution (ERES)				
Sensitivity	50 Ω (ProLink): 2 mV–1 V/div, fully variable (2–9.9 mV/div via zoom) 50 Ω (ProBus): 2 mV–1 V/div, fully variable 1 M Ω (ProBus): 2 mV–10 V/div, fully variable				
DC Gain Accuracy	$\pm 1.5\%$ of full scale				
Offset Range	50 Ω (ProLink): ± 500 mV @ 2–100 mV/div ± 4 V @ > 102 mV/div–1 V/div 50 Ω (ProBus): ± 750 mV @ 2–100 mV/div ± 4 V @ > 102 mV/div–1 V/div 1 MΩ: ± 1 V @ 2–140 mV/div ± 10 V @ 142 mV–1.40 V/div ± 100 V @ 1.42 V–10 V/div				
Offset Accuracy	$\pm(1.5\%$ of full scale + 1.5% of offset value + 2 mV)				
Horizontal System					
Timebases	Internal timebase common to 4 input channels an external clock may be applied at the auxiliary input				
Time/Division Range	5 ps/div–320 s/div (Real-time mode: 5 ps/div–20 s/div RIS mode: 5 ps/div–10 ns/div Roll mode: up to 320 s/div)				
Clock Accuracy	< 1 ppm + (aging of 0.5 ppm/yr from last calibration)				
Time Interval Accuracy	< 0.06 / SR + (clock accuracy* Reading) (rms)				
Jitter Noise Floor	< 500 fs (typical)				
Trigger and Interpolator Jitter	2 ps rms (typical) < 0.1 ps rms (typical, software assisted)				
Channel-Channel Deskew Range	± 9 x time/div. setting, 100 ms max., each channel				
External Timebase Reference (Input)	10 MHz 50 Ω impedance, applied at the rear input				
External Timebase Reference (Output)	10 MHz 50 Ω impedance, output at the rear				

SPECIFICATIONS

Vertical System	WaveMaster 820Zi (SDA)	WaveMaster 825Zi (SDA, DDA)	WaveMaster 830Zi (SDA)
Analog (2.92 mm Input) Bandwidth @ 50 Ω (-3 dB)	20 GHz (≥ 10 mV/div)	25 GHz (≥ 10 mV/div)	30 GHz (≥ 10 mV/div)
Analog (ProLink Input) Bandwidth @ 50 Ω (-3 dB)	16 GHz (≥ 10 mV/div)	16 GHz (≥ 10 mV/div)	16 GHz (≥ 10 mV/div)
Analog (ProBus Input) Bandwidth @ 50 Ω (-3 dB)	3.5 GHz (≥ 10 mV/div)	3.5 GHz (≥ 10 mV/div)	3.5 GHz (≥ 10 mV/div)
Analog (ProBus Input) Bandwidth @ 1 MΩ (-3 dB)	500 MHz (typical, ≥ 2 mV/div)		
Rise Time (typical, 10–90%, 50 Ω)	21 ps	19 ps (@ full BW)	17 ps (@ full BW)
Rise Time (typical, 20–80%, 50 Ω)	16 ps	14 ps	13 ps
Input Channels	4 (@ 16 GHz), 2 (@ full BW)		
Bandwidth Limiters	20 MHz, 200 MHz, 1 GHz, 4 GHz, 6 GHz, 8 GHz, 13 GHz		
Input Impedance	50 Ω ±2% or 1 MΩ 16 pF, 10 MΩ 11 pF with supplied probe		
Input Coupling	2.92 mm Inputs: 50 Ω: DC, GND ProLink Inputs: 50 Ω: DC, GND ProBus Inputs: 1 MΩ: AC, DC, GND; 50 Ω: DC, GND		
Maximum Input Voltage	2.92 mm Inputs: ±2 V max. @ ≤ 100 mV/div, 5.5 V _{rms} @ > 100 mV/div 50 Ω (ProLink): ±2 V max. @ ≤ 100 mV/div, 5.5 V _{rms} @ > 100 mV/div 50 Ω (ProBus): ±5 V max., 3.5 V _{rms} 1 MΩ (ProBus): 250 V max. (peak AC: < 10 kHz + DC)		
Vertical Resolution	8 bits up to 11 bits with enhanced resolution (ERES)		
Sensitivity	50 Ω (2.92 mm): 10 mV–500 mV/div 50 Ω (ProLink): 2 mV–1 V/div, fully variable (2–9.9 mV/div via zoom) 50 Ω (ProBus): 2 mV–1 V/div, fully variable 1 MΩ (ProBus): 2 mV–10 V/div, fully variable		
DC Gain Accuracy	±1.5% of full scale		
Offset Range	50 Ω (2.92 mm): ±500 mV @ 2–74 mV/div ±4 V @ > 76 mV/div–500 mV/div 50 Ω (ProLink): ±500 mV @ 2–100 mV/div ±4 V @ > 102 mV/div–1 V/div 50 Ω (ProBus): ±750 mV @ 2–100 mV/div ±4 V @ > 102 mV/div–1 V/div 1 MΩ: ±1 V @ 2–140 mV/div ±10 V @ 142 mV–1.40 V/div ±100 V @ 1.42 V–10 V/div		
Offset Accuracy	±(1.5% of full scale + 1.5% of offset value + 2 mV)		
Horizontal System			
Timebases	Internal timebase common to 4 input channels an external clock may be applied at the auxiliary input		
Time/Division Range	For ≥ 20 GHz mode: Real-time mode, 5 ps/div–25 μs/div (upper time/div is a function of memory available at 80 GS/s. For VL memory, upper time/div is 640 μs/div) For < 20 GHz mode: 5 ps/div–320 s/div (Real-time mode: 5 ps/div–20 s/div; RIS mode: 5 ps/div–10 ns/div; Roll mode: up to 320 s/div)		
Clock Accuracy	< 1 ppm + (aging of 0.5 ppm/yr from last calibration)		
Time Interval Accuracy	< 0.06 / SR + (clock accuracy* Reading) (rms)		
Jitter Noise Floor	< 500 fs (typical)		
Trigger and Interpolator Jitter	2 ps rms (typical) < 0.1 ps rms (typical, software assisted)		
Channel-Channel Deskew Range	±9 x time/div. setting, 100 ms max., each channel		
External Timebase Reference (Input)	10 MHz 50 Ω impedance, applied at the rear input		
External Timebase Reference (Output)	10 MHz 50 Ω impedance, output at the rear		

SPECIFICATIONS

Acquisition System	WaveMaster 804Zi (SDA)	WaveMaster 806Zi (SDA)	WaveMaster 808Zi (SDA)	WaveMaster 813Zi (SDA)	WaveMaster 816Zi (SDA, DDA)
Single-Shot Sample Rate/Ch	40 GS/s on 4 Ch (80 GS/s on 2 Ch using optional WM8Zi-2X80GS External Interleaving Device)				
Random Interleaved Sampling (RIS)	200 GS/s for repetitive signals (20 ps/div to 10 ns/div)				
Maximum Trigger Rate	1,000,000 waveforms/second (in Sequence Mode, up to 4 channels)				
Intersegment Time	1 μ s				
Maximum Acquisition and Analysis					Number of Segments
Memory Points/Ch	4 Ch Memory				
Standard Memory	10 Mpts (20 Mpts for SDA, DDA models) Memory can be doubled in 2 Ch and 80 GS/s mode with use of optional WM8Zi-2X80GS External Interleaving Device				5,000
S-32 – Memory Option	32 Mpts Memory and Sample Rate can be doubled in 2 Ch mode with use of optional WM8Zi-2X80GS External Interleaving Device				15,000
M-64 – Memory Option	64 Mpts Memory and Sample Rate can be doubled in 2 Ch mode with use of optional WM8Zi-2X80GS External Interleaving Device				15,000
L-128 – Memory Option	128 Mpts Memory and Sample Rate can be doubled in 2 Ch mode with use of optional WM8Zi-2X80GS External Interleaving Device				15,000
VL-256 – Memory Option	256 Mpts Memory and Sample Rate can be doubled in 2 Ch mode with use of optional WM8Zi-2X80GS External Interleaving Device				15,000

Acquisition Processing

Averaging	Summed averaging to 1 million sweeps continuous averaging to 1 million sweeps
Enhanced Resolution (ERES)	From 8.5 to 11 bits vertical resolution
Envelope (Extrema)	Envelope, floor, or roof for up to 1 million sweeps
Interpolation	Linear or Sin x/x

Triggering System

Modes	Normal, Auto, Single, and Stop				
Sources	Any input channel, Aux, Aux/10, or line slope and level unique to each source (except line trigger)				
Coupling Mode	DC, AC, HFRej, LFRej				
Pre-trigger Delay	0–100% of memory size (adjustable in 1% increments of 100 ns)				
Post-trigger Delay	0–10,000 divisions in real time mode, limited at slower time/div settings or in roll mode				
Hold-off by Time or Events	From 2 ns up to 20 s or from 1 to 99,999,999 events				
Internal Trigger Range	\pm 4.1 div from center				
Trigger Sensitivity with Edge Trigger (Ch 1–4) ProLink Inputs	2 div @ < 3.5 GHz 1.5 div @ < 1.75 GHz 1.0 div @ < 200 MHz (for DC, AC, LFRej coupling, \geq 10 mV/div, 50 Ω)	2 div @ < 4 GHz 1.5 div @ < 3 GHz 1.0 div @ < 200 MHz (for DC, AC, LFRej coupling, \geq 10 mV/div, 50 Ω)	2 div @ < 6 GHz 1.5 div @ < 3 GHz 1.0 div @ < 200 MHz (for DC, AC, LFRej coupling, \geq 10 mV/div, 50 Ω)	2 div @ < 13 GHz 1.5 div @ < 3 GHz 1.0 div @ < 200 MHz (for DC, AC, LFRej coupling, \geq 10 mV/div, 50 Ω)	2 div @ < 15 GHz 1.5 div @ < 3 GHz 1.0 div @ < 200 MHz (for DC, AC, LFRej coupling, \geq 10 mV/div, 50 Ω)
Trigger Sensitivity with Edge Trigger (Ch 1–4) ProBus Inputs	2 div @ < 3.5 GHz 1.5 div @ < 3 GHz 1.0 div @ < 200 MHz (for DC, AC, LFRej coupling, \geq 10 mV/div, 50 Ω)				
External Trigger Sensitivity, (Edge Trigger)	2 div @ < 1 GHz 1.5 div @ < 500 MHz 1.0 div @ < 200 MHz (for DC, AC, LFRej coupling)				
Max. Trigger Frequency, SMART Trigger	2.0 GHz @ \geq 10 mV/div (minimum triggerable width 200 ps)				
External Trigger Input Range	Aux (\pm 0.4 V); Aux/10 (\pm 4 V)				

SPECIFICATIONS

Acquisition System	WaveMaster 820Zi (SDA)	WaveMaster 825Zi (SDA, DDA)	WaveMaster 830Zi (SDA)
Single-Shot Sample Rate/Ch	80 GS/s at full bandwidth on 2 channels 40 GS/s on 4 Ch		
Random Interleaved Sampling (RIS)	Not Applicable		
Maximum Trigger Rate	1,000,000 waveforms/second (in Sequence Mode, up to 4 channels)		
Intersegment Time	1 μ s		
Maximum Acquisition and Analysis Memory Points/Ch	4 Ch Memory		Number of Segments
Standard Memory	10 Mpts (20 Mpts for SDA, DDA models) (20 Mpts on 2 Ch when operated in Digital Bandwidth Interleave mode)		5,000
S-32 – Memory Option	32 Mpts (64 Mpts on 2 Ch when operated in Digital Bandwidth Interleave mode)		15,000
M-64 – Memory Option	64 Mpts (128 Mpts on 2 Ch when operated in Digital Bandwidth Interleave mode)		15,000
L-128 – Memory Option	128 Mpts (256 Mpts on 2 Ch when operated in Digital Bandwidth Interleave mode)		15,000
VL-256 – Memory Option	256 Mpts (512 Mpts on 2 Ch when operated in Digital Bandwidth Interleave mode)		15,000
Acquisition Processing			
Averaging	Summed averaging to 1 million sweeps continuous averaging to 1 million sweeps		
Enhanced Resolution (ERES)	From 8.5 to 11 bits vertical resolution		
Envelope (Extrema)	Envelope, floor, or roof for up to 1 million sweeps		
Interpolation	Linear or Sin x/x		
Triggering System			
Modes	Normal, Auto, Single, and Stop		
Sources	Any input channel, Aux, Aux/10, or line slope and level unique to each source (except line trigger)		
Coupling Mode	DC, AC, HFRej, LFRrej		
Pre-trigger Delay	0–100% of memory size (adjustable in 1% increments of 100 ns)		
Post-trigger Delay	0–10,000 divisions in real time mode, limited at slower time/div settings or in roll mode		
Hold-off by Time or Events	From 2 ns up to 20 s or from 1 to 99,999,999 events		
Internal Trigger Range	± 4.1 div from center		
Trigger Sensitivity with Edge Trigger (Ch 1–4) ProLink Link and 2.92 mm Inputs	2 div @ < 15 GHz 1.5 div @ < 3 GHz 1.0 div @ < 200 MHz (for DC, AC, LFRrej coupling, ≥ 10 mV/div, 50 Ω)		
Trigger Sensitivity with Edge Trigger (Ch 1–4) ProBus Inputs	2 div @ < 3.5 GHz 1.5 div @ < 3 GHz 1.0 div @ < 200 MHz (for DC, AC, LFRrej coupling, ≥ 10 mV/div, 50 Ω)		
External Trigger Sensitivity, (Edge Trigger)	2 div @ < 1 GHz 1.5 div @ < 500 MHz 1.0 div @ < 200 MHz (for DC, AC, LFRrej coupling)		
Max. Trigger Frequency, SMART Trigger	2.0 GHz @ ≥ 10 mV/div (minimum triggerable width 200 ps)		
External Trigger Input Range	Aux (± 0.4 V); Aux/10 (± 4 V)		

SPECIFICATIONS

Basic Triggers	WaveMaster 804Zi (SDA)	WaveMaster 806Zi (SDA)	WaveMaster 808Zi (SDA)	WaveMaster 813Zi (SDA)	WaveMaster 816Zi (SDA, DDA)
Edge	Triggers when signal meets slope (positive, negative, or either) and level condition				
Window	Triggers when signal exits a window defined by adjustable thresholds				
TV-Composite Video	Triggers NTSC or PAL with selectable line and field HDTV (720p, 1080i, 1080p) with selectable frame rate (50 or 60 Hz) and Line or CUSTOM with selectable Fields (1–8), Lines (up to 2000), Frame Rates (25, 30, 50, or 60 Hz), Interlacing (1:1, 2:1, 4:1, 8:1), or Synch Pulse Slope (Positive or Negative)				

SMART Triggers™

State or Edge Qualified	Triggers on any input source only if a defined state or edge occurred on another input source. Delay between sources is selectable by time or events
Qualified First	In Sequence acquisition mode, triggers repeatably on event B only if a defined pattern, state, or edge (event A) is satisfied in the first segment of the acquisition. Delay between sources is selectable by time or events
Dropout	Triggers if signal drops out for longer than selected time between 1 ns and 20 s
Pattern	Logic combination (AND, NAND, OR, NOR) of 5 inputs (4 channels and external trigger input). Each source can be high, low, or don't care. The High and Low level can be selected independently. Triggers at start or end of the pattern

SMART Triggers with Exclusion Technology

Glitch	Triggers on positive or negative glitches with widths selectable as low as 200 ps (depending on oscilloscope bandwidth) to 20 s, or on intermittent faults
Width (Signal or Pattern)	Triggers on positive, negative, or both widths with widths selectable as low as 200 ps (depending on oscilloscope bandwidth) to 20 s, or on intermittent faults
Interval (Signal or Pattern)	Triggers on intervals selectable between 1 ns and 20 s
Timeout (State/Edge Qualified)	Triggers on any source if a given state (or transition edge) has occurred on another source. Delay between sources is 1 ns to 20 s, or 1 to 99,999,999 events
Runt	Trigger on positive or negative runts defined by two voltage limits and two time limits. Select between 1 ns and 20 ns
Slew Rate	Trigger on edge rates. Select limits for dV, dt, and slope. Select edge limits between 1 ns and 20 ns
Exclusion Triggering	Trigger on intermittent faults by specifying the expected behavior and triggering when that condition is not met

Cascade (Sequence) Triggering

Capability	Arm on "A" event, then Trigger on "B" event. Or Arm on "A" event, then Qualify on "B" event, and Trigger on "C" event. Or Arm on "A" event, then Qualify on "B" then "C" event, and Trigger on "D" event
Types	A or B event: Edge, Glitch, Width, Window, Dropout, Interval, Runt, Slew Rate, or Pattern (analog) C or D event: Edge or Pattern
Holdoff	Delay between A and B, B and C, C and D, are all selectable by time or number of events
Reset	Reset between A and B, B and C, C and D, are all selectable in time

High-speed Serial Protocol Triggering (Option WM8Zi-HSPT)

Data Rates	100 Mb/s–2.7 Gb/s, 3.0, 3.125 Gb/s (standard with SDA 8 Zi models)
Pattern Length	80-bits, NRZ or 8b/10b
Clock and Data Outputs	400 mV _{p-p} (typical) AC coupled
Clock Recovery Jitter	2 ps rms + 0.3% Unit Interval rms for PRBS data patterns with 50% transition density (typical)
Hardware Clock Recovery Loop BW	PLL Loop BW = Fbaud/5500, 100 Mb/s to 1.25 Gb/s (typical)

Low-speed Serial Protocol Triggering (Optional)

Optionally Available	I ² C, SPI (SPI, SSPI, SIOP), UART-RS232, CAN, LIN, FlexRay
----------------------	--

Color Waveform Display

Type	Color 15.3" flat panel TFT-Active Matrix LCD with high resolution touch screen
Resolution	WXGA 1280 x 768 pixels
Number of Traces	Display a maximum of 8 traces. Simultaneously display channel, zoom, memory and math traces
Grid Styles	Auto, Single, Dual, Quad, Octal, X-Y, Single+X-Y, Dual+X-Y
Waveform Representation	Sample dots joined, or sample dots only

SPECIFICATIONS

SPECIFICATIONS

Basic Triggers	WaveMaster 820Zi (SDA)	WaveMaster 825Zi (SDA, DDA)	WaveMaster 830Zi (SDA)
Edge	Triggers when signal meets slope (positive, negative, or either) and level condition		
Window	Triggers when signal exits a window defined by adjustable thresholds		
TV-Composite Video	Triggers NTSC or PAL with selectable line and field HDTV (720p, 1080i, 1080p) with selectable frame rate (50 or 60 Hz) and Line or CUSTOM with selectable Fields (1–8), Lines (up to 2000), Frame Rates (25, 30, 50, or 60 Hz), Interlacing (1:1, 2:1, 4:1, 8:1), or Synch Pulse Slope (Positive or Negative)		

SMART Triggers™

State or Edge Qualified	Triggers on any input source only if a defined state or edge occurred on another input source. Delay between sources is selectable by time or events		
Qualified First	In Sequence acquisition mode, triggers repeatably on event B only if a defined pattern, state, or edge (event A) is satisfied in the first segment of the acquisition. Delay between sources is selectable by time or events		
Dropout	Triggers if signal drops out for longer than selected time between 1 ns and 20 s.		
Pattern	Logic combination (AND, NAND, OR, NOR) of 5 inputs (4 channels and external trigger input). Each source can be high, low, or don't care. The High and Low level can be selected independently. Triggers at start or end of the pattern		

SMART Triggers with Exclusion Technology

Glitch	Triggers on positive or negative glitches with widths selectable as low as 200 ps (depending on oscilloscope bandwidth) to 20 s, or on intermittent faults		
Width (Signal or Pattern)	Triggers on positive, negative, or both widths with widths selectable as low as 200 ps (depending on oscilloscope bandwidth) to 20 s, or on intermittent faults		
Interval (Signal or Pattern)	Triggers on intervals selectable between 1 ns and 20 s		
Timeout (State/Edge Qualified)	Triggers on any source if a given state (or transition edge) has occurred on another source. Delay between sources is 1 ns to 20 s, or 1 to 99,999,999 events		
Runt	Trigger on positive or negative runts defined by two voltage limits and two time limits. Select between 1 ns and 20 ns		
Slew Rate	Trigger on edge rates. Select limits for dV, dt, and slope. Select edge limits between 1 ns and 20 ns		
Exclusion Triggering	Trigger on intermittent faults by specifying the expected behavior and triggering when that condition is not met		

Cascade (Sequence) Triggering

Capability	Arm on "A" event, then Trigger on "B" event. Or Arm on "A" event, then Qualify on "B" event, and Trigger on "C" event. Or Arm on "A" event, then Qualify on "B" then "C" event, and Trigger on "D" event		
Types	A or B event: Edge, Glitch, Width, Window, Dropout, Interval, Runt, Slew Rate, or Pattern (analog) C or D event: Edge or Pattern		
Holdoff	Delay between A and B, B and C, C and D, are all selectable by time or number of events		
Reset	Reset between A and B, B and C, C and D, are all selectable in time		

High-speed Serial Protocol Triggering (Option WM8Zi-HSPT)

Data Rates	100 Mb/s–2.7 Gb/s, 3.0, 3.125 Gb/s (standard with SDA 8 Zi models)		
Pattern Length	80-bits, NRZ or 8b/10b		
Clock and Data Outputs	400 mV _{p-p} (typical) AC coupled		
Clock Recovery Jitter	2 ps rms + 0.3% Unit Interval rms for PRBS data patterns with 50% transition density (typical)		
Hardware Clock Recovery Loop BW	PLL Loop BW = Fbaud/5500, 100 Mb/s to 1.25 Gb/s (typical)		

Low-speed Serial Protocol Triggering (Optional)

Optionally available	I ² C, SPI (SPI, SSPI, SIOP), UART-RS232, CAN, LIN, FlexRay		
----------------------	--	--	--

Color Waveform Display

Type	Color 15.3" flat panel TFT-Active Matrix LCD with high resolution touch screen		
Resolution	WXGA 1280 x 768 pixels		
Number of Traces	Display a maximum of 8 traces. Simultaneously display channel, zoom, memory and math traces		
Grid Styles	Auto, Single, Dual, Quad, Octal, X-Y, Single+X-Y, Dual+X-Y		
Waveform Representation	Sample dots joined, or sample dots only		

SPECIFICATIONS

Integrated Second Display	WaveMaster 804Zi (SDA)	WaveMaster 806Zi (SDA)	WaveMaster 808Zi (SDA)	WaveMaster 813Zi (SDA)	WaveMaster 816Zi (SDA, DDA)
Type	Color 15.3" flat panel TFT-Active Matrix LCD with high resolution touch screen				
Resolution	WXGA 1280 x 768 pixels				

LeCroy WaveStream Fast Viewing Mode

Intensity	256 Intensity Levels, 1–100% adjustable via front panel control
Types	Select analog or color-graded
Number of Channels	Up to 4 simultaneously
Max. Sampling Rate	40 GS/s (80 GS/s with optional WM8Zi-2X80GS external interleaving device)
Persistence Aging	Select from 500 ms to Infinity
Waveforms/Second (Continuous)	Up to 2500 waveforms/second

Analog Persistence Display

Analog and Color-Graded Persistence	Variable saturation levels stores each trace's persistence data in memory
Persistence Types	Select analog, color, or three-dimensional
Trace Selection	Activate persistence on all or any combination of traces
Persistence Aging	Select from 500 ms to infinity
Sweep Display Modes	All accumulated, or all accumulated with last trace highlighted

High-speed Digitizer Output (Option)

Type	LeCroy LSIB
Transfer Rate	Up to 325 MB/s (Typical)
Output Protocol	PCI Express®, Gen1 (4 lanes utilized for data transfer)
Control Protocol	TCP/IP
Command Set	Via Windows Automation, or via LeCroy Remote Command Set

Zoom Expansion Traces

Display up to 4 Zoom and 8 Math/Zoom traces

Processor/CPU

Type	Intel® Core™ 2 Quad, 2.5 GHz (or better)
Processor Memory	4 GB standard, up to 8 GB optional (8 GB standard with "M-64", "L-128", or "VL-256" memory)
Operating System	Microsoft Windows® Vista® Business Edition (64-bit) with SP1
Real Time Clock	Date and time displayed with waveform an in hardcopy files. SNTP support to synchronize to precision internal clocks

Internal Waveform Memory

4 active waveform memory traces (M1-M4) store 16-bit/point full length waveforms.
Waveforms can be stored to any number of files limited only by the data storage media capacity

Setup Storage

Front Panel and Instrument Status	Store to the internal hard drive or to a USB-connected peripheral device
-----------------------------------	--

Interface

Remote Control	Via Windows Automation, or via LeCroy Remote Command Set
Network Communication Standard	VXI-11 or VICP, LXI Class C Compliant
GPIB Port (Optional)	Supports IEEE – 488.2
LSIB Port (Optional)	Supports PCIe Gen1 x4 protocol with LeCroy supplied API
Ethernet Port	Supports 10/100/1000BaseT Ethernet interface (RJ45 port)
USB Ports	Minimum 6 total (incl. 3 front panel) USB 2.0 ports support Windows compatible devices
External Monitor Port	15-pin D-Type WXGA compatible to support customer-supplied external monitor. DVI connector to support LeCroy Zi-EXTDISP-15 additional touch screen display accessory. Includes support for extended desktop operation with optional LeCroy or other second monitor
Peripheral Bus	LeCroy LBUS standard

SPECIFICATIONS

Integrated Second Display	WaveMaster 820Zi (SDA)	WaveMaster 825Zi (SDA, DDA)	WaveMaster 830Zi (SDA)
Type	Color 15.3" flat panel TFT-Active Matrix LCD with high resolution touch screen		
Resolution	WXGA 1280 x 768 pixels		

LeCroy WaveStream Fast Viewing Mode

Intensity	256 Intensity Levels, 1–100% adjustable via front panel control
Types	Select analog or color-graded
Number of Channels	Up to 4 simultaneously
Max. Sampling Rate	40 GS/s (80 GS/s when operated in Digital Bandwidth Interleave mode)
Persistence Aging	Select from 500 ms to Infinity
Waveforms/Second (Continuous)	Up to 2500 waveforms/second

Analog Persistence Display

Analog and Color-Graded Persistence	Variable saturation levels stores each trace's persistence data in memory
Persistence Types	Select analog, color, or three-dimensional
Trace Selection	Activate persistence on all or any combination of traces
Persistence Aging	Select from 500 ms to infinity
Sweep Display Modes	All accumulated, or all accumulated with last trace highlighted

High-speed Digitizer Output (Option)

Type	LeCroy LSIB
Transfer Rate	Up to 325 MB/s (Typical)
Output Protocol	PCI Express®, Gen1 (4 lanes utilized for data transfer)
Control Protocol	TCP/IP
Command Set	Via Windows Automation, or via LeCroy Remote Command Set

Zoom Expansion Traces

Display up to 4 Zoom and 8 Math/Zoom traces

Processor/CPU

Type	Intel® Core™ 2 Quad, 2.5 GHz (or better)
Processor Memory	4 GB standard, up to 8 GB optional (8 GB standard with "M-64", "L-128", or "VL-256" memory)
Operating System	Microsoft Windows® Vista® Business Edition (64-bit) with SP1
Real Time Clock	Date and time displayed with waveform an in hardcopy files. SNTP support to synchronize to precision internal clocks

Internal Waveform Memory

4 active waveform memory traces (M1-M4) store 16 bit/point full length waveforms. Waveforms can be stored to any number of files limited only by the data storage media capacity

Setup Storage

Front Panel and Instrument Status	Store to the internal hard drive or to a USB-connected peripheral device
-----------------------------------	--

Interface

Remote Control	Via Windows Automation, or via LeCroy Remote Command Set
Network Communication Standard	VXI-11 or VICP, LXI Class C Compliant
GPIB Port (Optional)	Supports IEEE – 488.2
LSIB Port (Optional)	Supports PCIe Gen1 x4 protocol with LeCroy supplied API
Ethernet Port	Supports 10/100/1000BaseT Ethernet interface (RJ45 port)
USB Ports	Minimum 6 total (incl. 3 front panel) USB 2.0 ports support Windows compatible devices
External Monitor Port	15-pin D-Type WXGA compatible to support customer-supplied external monitor. DVI connector to support LeCroy Zi-EXTDISP-15 additional touch screen display accessory. Includes support for extended desktop operation with optional LeCroy or other second monitor
Peripheral Bus	LeCroy LBUS standard

SPECIFICATIONS

	WaveMaster 804Zi (SDA)	WaveMaster 806Zi (SDA)	WaveMaster 808Zi (SDA)	WaveMaster 813Zi (SDA)	WaveMaster 816Zi (SDA, DDA)
Auxiliary Input					
Signal Types	External Trigger				
Coupling	50 Ω : DC 1 M Ω : AC, DC, GND				
Max. Input Voltage	50 Ω : 5 V _{rms} 1 M Ω : 250 V (Peak AC < 10 kHz + DC)				
Auxiliary Output					
Signal Types	Select from calibrator, control signals or Off				
Calibrator Signal	500 Hz–5 MHz square wave or DC level 0.0 to 500 mV into 50 Ω (0–1 V into 1 M Ω)				
Control Signals	Trigger enabled, trigger out, pass/fail status				
Automatic Setup					
Auto Setup	Automatically sets timebase, trigger, and sensitivity to display a wide range of repetitive signals				
Find Vertical Scale	Automatically sets the vertical sensitivity and offset for the selected channel to display a waveform with the maximum dynamic range				
General					
Auto Calibration	Ensures specified DC and timing accuracy is maintained for 1 year minimum				
Probes					
Probes	Qty. (4) \pm 10 Passive Probes				
Probe System	ProBus and ProLink. Automatically detects and supports a variety of compatible probes				
Scale Factors	Automatically or manually selected depending on probe used				
Calibration Output	1 kHz square wave, 1 V _{p-p} (typical), output to probe hook				
Power Requirements					
Voltage	100–240 VAC \pm 10% at 45–66 Hz 100–120 VAC \pm 10% at 380–420 Hz Automatic AC Voltage Selection				
Max. Power Consumption	975 W / 975 VA				
Environmental					
Temperature (Operating)	+5 $^{\circ}$ C to +40 $^{\circ}$ C including CD-RW/DVD-ROM drive				
Temperature (Non-Operating)	–20 $^{\circ}$ C to +60 $^{\circ}$ C				
Humidity (Operating)	5% to 80% relative humidity (non-condensing) up to +31 $^{\circ}$ C. Upper limit derates to 50% relative humidity (non-condensing) at +40 $^{\circ}$ C				
Humidity (Non-Operating)	5% to 95% relative humidity (non-condensing) as tested per MIL-PRF-28800F				
Altitude (Operating)	Up to 10,000 ft. (3048 m) at or below +25 $^{\circ}$ C				
Altitude (Non-Operating)	Up to 40,000 ft. (12,192 m)				
Random Vibration (Operating)	0.5 g _{rms} overall level, 5 Hz to 500 Hz, 10 minutes in each of three orthogonal axes, 30 minutes total				
Random Vibration (Non-Operating)	2.0 g _{rms} overall level, 5 Hz to 500 Hz, 10 minutes in each of three orthogonal axes, 30 minutes total				
Functional Shock	20 g _{peak} , half sine, 11 ms pulse, 3 shocks (positive and negative) in each of three orthogonal axes, 18 shocks total				
Physical Dimensions					
Dimensions (HWD)	14" H x 18.4" W x 15.3" D (355 x 467 x 390 mm) height excludes feet				
Weight	51.5 lbs. (23.4 kg)				
Shipping Weight	70.0 lbs. (31.8 kg)				
Certifications					
	CE Compliant, UL and cUL listed conforms to EN 61326-1, EN 61010-1, UL 61010-1 2nd edition, and CSA C22.2 No. 61010-1-04				
Warranty and Service					
	3-year warranty calibration recommended annually. Optional service programs include extended warranty, upgrades, and calibration services.				

SPECIFICATIONS

	WaveMaster 820Zi (SDA)	WaveMaster 825Zi (SDA, DDA)	WaveMaster 830Zi (SDA)
Auxiliary Input			
Signal Types	Select External Trigger or External Clock Input on the front panel		
Coupling	50 Ω : DC 1 M Ω : AC, DC, GND		
Max. Input Voltage	50 Ω : 5 V _{rms} 1 M Ω : 250 V (Peak AC < 10 kHz + DC)		
Auxiliary Output			
Signal Types	Select from calibrator, control signals or Off		
Calibrator Signal	500 Hz–5 MHz square wave or DC level 0.0 to 500 mV into 50 Ω (0–1 V into 1 M Ω)		
Control Signals	Trigger enabled, trigger out, pass/fail status		
Automatic Setup			
Auto Setup	Automatically sets timebase, trigger, and sensitivity to display a wide range of repetitive signals		
Find Vertical Scale	Automatically sets the vertical sensitivity and offset for the selected channel to display a waveform with the maximum dynamic range		
General			
Auto Calibration	Ensures specified DC and timing accuracy is maintained for 1 year minimum		
Probes			
Probes	Qty. (4) \pm 10 Passive Probes		
Probe System	ProBus and ProLink. Automatically detects and supports a variety of compatible probes		
Scale Factors	Automatically or manually selected depending on probe used		
Calibration Output	1 kHz square wave, 1 V _{p-p} (typical), output to probe hook		
Power Requirements			
Voltage	100–240 VAC \pm 10% at 45–66 Hz 100–120 VAC \pm 10% at 380–420 Hz Automatic AC Voltage Selection		
Max. Power Consumption	1025 W / 1025 VA		
Environmental			
Temperature (Operating)	+5 $^{\circ}$ C to +40 $^{\circ}$ C including CD-RW/DVD-ROM drive		
Temperature (Non-Operating)	–20 $^{\circ}$ C to +60 $^{\circ}$ C		
Humidity (Operating)	5% to 80% relative humidity (non-condensing) up to +31 $^{\circ}$ C. Upper limit derates to 50% relative humidity (non-condensing) at +40 $^{\circ}$ C		
Humidity (Non-Operating)	5% to 95% relative humidity (non-condensing) as tested per MIL-PRF-28800F		
Altitude (Operating)	Up to 10,000 ft. (3048 m) at or below +25 $^{\circ}$ C		
Altitude (Non-Operating)	Up to 40,000 ft. (12,192 m)		
Random Vibration (Operating)	0.5 g _{rms} overall level, 5 Hz to 500 Hz, 10 minutes in each of three orthogonal axes, 30 minutes total		
Random Vibration (Non-Operating)	2.0 g _{rms} overall level, 5 Hz to 500 Hz, 10 minutes in each of three orthogonal axes, 30 minutes total		
Functional Shock	20 g _{peak} , half sine, 11 ms pulse, 3 shocks (positive and negative) in each of three orthogonal axes, 18 shocks total		
Physical Dimensions			
Dimensions (HWD)	14" H x 18.4" W x 15.3" D (355 x 467 x 390 mm) height excludes feet		
Weight	58 lbs. (26.3 kg)		
Shipping Weight	76 lbs. (34.5 kg)		
Certifications			
	CE Compliant, UL and cUL listed conforms to EN 61326-1, EN 61010-1, UL 61010-1 2nd edition, and CSA C22.2 No. 61010-1-04		
Warranty and Service			
	3-year warranty calibration recommended annually. Optional service programs include extended warranty, upgrades, and calibration services.		

SPECIFICATIONS

Standard

Math Tools

Display up to 8 math function traces (F1–F8). The easy-to-use graphical interface simplifies setup of up to two operations on each function trace, and function traces can be chained together to perform math-on-math.

absolute value	interpolate
average (summed)	(cubic, quadratic, $\sin x/x$)
average (continuous)	invert (negate)
correlation (two waveforms)	log (base e)
derivative	log (base 10)
deskew (resample)	product (x)
difference (–)	ratio (/)
enhanced resolution (to 11 bits vertical)	reciprocal
envelope	rescale (with units)
exp (base e)	roof
exp (base 10)	($\sin x$)/x
fft (power spectrum, magnitude, phase, up to 128 Mpts)	sparse
floor	square
integral	square root
	sum (+)
	zoom (identity)

Measure Tools

Display any 12 parameters together with statistics, including their average, high, low, and standard deviations. Histograms provide a fast, dynamic view of parameters and wave shape characteristics. Parameter Math allows addition, subtraction, multiplication, or division of two different parameters.

amplitude	level @ x	rms
area	maximum	std. deviation
base	mean	top
cycles	median	width
data	minimum	median
delay	narrow band phase	phase
Δ delay	narrow band power	time @ minimum (min.)
duty cycle	number of points	time @ maximum (max.)
duration	+overshoot	Δ time @ level
falltime (90–10%, 80–20%, @ level)	–overshoot	Δ time @ level from trigger
frequency	peak-to-peak	x@ max.
first	period	x@ min.
last	risetime (10–90%, 20–80%, @ level)	

Pass/Fail Testing

Simultaneously test multiple parameters against selectable parameter limits or pre-defined masks. Pass or fail conditions can initiate actions including document to local or networked files, e-mail the image of the failure, save waveforms, send a pulse out at the front panel auxiliary BNC output, or (with the GPIB option) send a GPIB SRQ.

Jitter and Timing

Parametric Measurements:

- Period@level • Width@level • Duty@level • Frequency@level
- TIE@level • Edge@level

Statistical Analysis:

Jitter Trend (1000 pts) • Histograms (1000 pts)

Software Options

SDA II Serial Data Analysis Software (WM8Zi-SDAII) (Standard on SDA 8 Zi and DDA 8 Zi)

Total Jitter

A complete toolset is provided to measure total jitter. Eye Diagrams with millions of UI are quickly calculated from up to 512 Mpts records, and advanced tools may be used on the Eye Diagram to aid analysis. Complete TIE and Total Jitter (Tj) parameters and analysis functions are provided.

- Time Interval Error (TIE) Measurement Parameter, Histogram, Spectrum and Jitter Track
- Total Jitter (Tj) Measurement Parameter, Histogram, Spectrum
- Eye Diagram Display (sliced)
- Eye Diagram IsoBER (lines of constant Bit Error Rate)
- Eye Diagram Mask Violation Locator
- Eye Diagram Measurement Parameters
 - Eye Height
 - One Level
 - Zero Level
 - Eye Amplitude
 - Eye Width
 - Eye Crossing
 - Avg. Power
 - Extinction Ratio
 - Mask hits
 - Mask out
 - Bit Error Rate
 - Slice Width (setting)
- Q-Fit Tail Representation
- Bathtub Curve
- Cumulative Density Function (CDF)
- PLL Track

Jitter Decomposition Models

Two jitter decomposition methods are provided and simultaneously calculated to provide maximum measurement confidence. Q-Scale, CDF, Bathtub Curve, and all jitter decomposition measurement parameters can be displayed using either method.

- Spectral Method
- NQ-Scale Method

Random Jitter (Rj) and Non-Data Dependent Jitter (Rj+BUj)

- Random Jitter (Rj) Measurement Parameter
- Rj+BUj Histogram
- Rj+BUj Spectrum
- Rj+BUj Track

Deterministic Jitter (Dj)

- Deterministic Jitter (Dj) Measurement Parameter

Data Dependent Jitter (DDj)

- Data Dependent Jitter (DDj) Measurement Parameter
- DDj Histogram
- DDj Plot (by Pattern or N-bit Sequence)

SPECIFICATIONS

Software Options

Cable De-embedding (WM8Zi-CBL-DE-EMBED)

(Standard on SDA 8 Zi and DDA 8 Zi)

Removes cable effects from your measurements. Simply enter the S-parameters or attenuation data of the cable(s) then all of the functionality of the SDA 8 Zi can be utilized with cable effects de-embedded.

8b/10b Decode (WM8Zi-8B10B D)

(Standard on SDA 8 Zi and DDA 8 Zi)

Intuitive, color-coded serial decode with powerful search capability enables captured waveforms to be searched for user-defined sequences of symbols. Multi-lane analysis decodes up to four simultaneously captured lanes.

Serial Data Mask (SDM) (WM8Zi-SDM)

(Standard on SDA 8 Zi and DDA 8 Zi)

Create eye diagrams using a comprehensive list of standard eye pattern masks, or create a user-defined mask. Mask violations are clearly marked on the display for easy analysis.

Electrical Telecom Pulse Mask Test (WM8Zi-ET-PMT)

Performs automated compliance mask tests on a wide range of electrical telecom standards.

Jitter and Timing Analysis Software Package (WM8Zi-JTA2)

(Standard on SDA 8 Zi and DDA 8 Zi)

This package provides jitter timing and analysis using time, frequency, and statistical views for common timing parameters, and also includes other useful tools. Includes:

- “Track” graphs of all parameters, no limitation of number
 - Cycle-Cycle Jitter
 - N-Cycle
 - N-Cycle with start selection
 - Frequency
 - Period
 - Half Period
 - Width
 - Time Interval Error
 - Setup
 - Hold
 - Skew
 - Duty Cycle
 - Duty Cycle Error
- Edge@lv parameter (counts edges)
- Histograms expanded with 19 histogram parameters and up to 2 billion events
- Trend (datalog) of up to 1 million events
- Track graphs of all parameters
- Persistence histogram, persistence trace (mean, range, sigma)

Spectrum Analyzer Mode (WM8Zi-SPECTRUM)

This package provides a new capability to navigate waveforms in the frequency domain using spectrum analyzer type controls.

FFT capability added to include:

- Power averaging
- Power density
- Real and imaginary components
- Frequency domain parameters
- FFT on up to 128 Mpts

Software Options

Disk Drive Measurements Package (WM8Zi-DDM2)

(Standard on DDA 8 Zi)

This package provides disk drive parameter measurements and related mathematical functions for performing disk drive WaveShape Analysis.

- Disk Drive Parameters are as follows:

amplitude assymetry	local time trough-peak
local base	local time under threshold
local baseline separation	narrow band phase
local maximum	narrow band power
local minimum	overwrite
local number	pulse width 50
local peak-peak	pulse width 50–
local time between events	pulse width 50+
local time between peaks	resolution
local time between troughs	track average amplitude
local time at minimum	track average amplitude–
local time at maximum	track average amplitude+
local time peak-trough	auto-correlation s/n
local time over threshold	non-linear transition shift

ORDERING INFORMATION

Product Description

Product Code

WaveMaster 8 Zi Series Oscilloscopes

4 GHz, 40 GS/s, 4 Ch, 10 Mpts/Ch WaveMaster with 15.3" WXGA Color Display. 50 Ω and 1 M Ω Input	WaveMaster 804Zi
6 GHz, 40 GS/s, 4 Ch, 10 Mpts/Ch WaveMaster with 15.3" WXGA Color Display. 50 Ω and 1 M Ω Input	WaveMaster 806Zi
8 GHz, 40 GS/s, 4 Ch, 10 Mpts/Ch WaveMaster with 15.3" WXGA Color Display. 50 Ω and 1 M Ω Input	WaveMaster 808Zi
13 GHz, 40 GS/s, 4 Ch, 10 Mpts/Ch WaveMaster with 15.3" WXGA Color Display. 50 Ω and 1 M Ω Input	WaveMaster 813Zi
16 GHz, 40 GS/s, 4 Ch, 10 Mpts/Ch WaveMaster with 15.3" WXGA Color Display. 50 Ω and 1 M Ω Input	WaveMaster 816Zi
20 GHz, 80 GS/s, 2 Ch, 20 Mpts/Ch WaveMaster with 15.3" WXGA Color Display. 50 Ω and 1 M Ω Input (16 GHz, 40 GS/s, 4 Ch, 10 Mpts/Ch)	WaveMaster 820Zi
25 GHz, 80 GS/s, 2 Ch, 20 Mpts/Ch WaveMaster with 15.3" WXGA Color Display. 50 Ω and 1 M Ω Input (16 GHz, 40 GS/s, 4 Ch, 10 Mpts/Ch)	WaveMaster 825Zi
30 GHz, 80 GS/s, 2 Ch, 20 Mpts/Ch WaveMaster with 15.3" WXGA Color Display. 50 Ω and 1 M Ω Input (16 GHz, 40 GS/s, 4 Ch, 10 Mpts/Ch)	WaveMaster 830Zi

SDA 8 Zi Series Serial Data Analyzers

4 GHz, 40 GS/s, 4 Ch, 20 Mpts/Ch Serial Data Analyzer with 15.3" WXGA Color Display. 50 Ω and 1 M Ω Input	SDA 804Zi
6 GHz, 40 GS/s, 4 Ch, 20 Mpts/Ch Serial Data Analyzer with 15.3" WXGA Color Display. 50 Ω and 1 M Ω Input	SDA 806Zi
8 GHz, 40 GS/s, 4 Ch, 20 Mpts/Ch Serial Data Analyzer with 15.3" WXGA Color Display. 50 Ω and 1 M Ω Input	SDA 808Zi
13 GHz, 40 GS/s, 4 Ch, 20 Mpts/Ch Serial Data Analyzer with 15.3" WXGA Color Display. 50 Ω and 1 M Ω Input	SDA 813Zi
16 GHz, 40 GS/s, 4 Ch, 20 Mpts/Ch Serial Data Analyzer with 15.3" WXGA Color Display. 50 Ω and 1 M Ω Input	SDA 816Zi
20 GHz, 80 GS/s, 2 Ch, 40 Mpts/Ch Serial Data Analyzer with 15.3" WXGA Color Display. 50 Ω and 1 M Ω Input (16 GHz, 40 GS/s, 4 Ch, 20 Mpts/Ch)	SDA 820Zi
25 GHz, 80 GS/s, 2 Ch, 40 Mpts/Ch Serial Data Analyzer with 15.3" WXGA Color Display. 50 Ω and 1 M Ω Input (16 GHz, 40 GS/s, 4 Ch, 20 Mpts/Ch)	SDA 825Zi
30 GHz, 80 GS/s, 2 Ch, 40 Mpts/Ch Serial Data Analyzer with 15.3" WXGA Color Display. 50 Ω and 1 M Ω Input (16 GHz, 40 GS/s, 4 Ch, 20 Mpts/Ch)	SDA 830Zi

DDA 8 Zi Series Oscilloscopes

16 GHz, 40 GS/s, 4ch, 20 Mpts/Ch DDA with 15.3" WXGA Color Display. 50 Ω and 1 M Ω Input	DDA 816Zi
25 GHz, 80 GS/s, 2 Ch, 40 Mpts/Ch DDA with 15.3" WXGA Color Display. 50 Ω and 1 M Ω Input (16 GHz, 40 GS/s, 4 Ch, 20 Mpts/Ch)	DDA 825Zi

Included with Standard Configuration

÷10, 500 MHz Passive Probe (Qty. 4 on 4–16 GHz units, Qty. 2 on 20–30 GHz units)	
ProLink to SMA Adapter: 4 each (for 4–8 GHz units)	LPA-SMA-A
ProLink to K/2.92 mm Adapter: 4 each (for 13–30 GHz units)	LPA-K-A
Optical 3-Button Wheel Mouse, USB 2.0	
Protective Front Cover	
Printed Quick Reference Guide	
Printed Getting Started Manual	
Product Manual in PDF Format on Scope Desktop	
Anti-virus Software (Trial Version)	
Microsoft Windows® Vista® License	
Commercial NIST Calibration with Performance Certificate	
Power Cable for the Destination Country	
3-year Warranty	

Product Description

Product Code

Memory and Sample Rate Options

80 GS/s on 2 Ch Sampling Rate Option for WaveMaster 8 Zi (not available for 820Zi, 825Zi or 830Zi). Includes two separate external interleaving devices with storage case	WM8Zi-2X80GS
10 Mpts/Ch Standard Memory for WaveMaster 8 Zi. Includes 4 GB of RAM	WM8Zi-STD
20 Mpts/Ch Standard Memory for SDA 8 Zi. Includes 4 GB of RAM	SDA8Zi-STD
20 Mpts/Ch Standard Memory for DDA 8 Zi. Includes 4 GB of RAM	DDA8Zi-STD
32 Mpts/Ch Memory Option for WaveMaster 8 Zi. SDA 8 Zi, and DDA 8 Zi. Includes 4 GB RAM standard	WM8Zi-S-32
32 Mpts/Ch Memory Option for SDA 8 Zi. Includes 4 GB RAM standard	SDA8Zi-S-32
32 Mpts/Ch Memory Option for DDA 8 Zi. Includes 4 GB RAM standard	DDA8Zi-S-32
64 Mpts/Ch Memory Option for WaveMaster 8 Zi. Includes an additional 4 GB of RAM (8 GB total)	WM8Zi-M-64
64 Mpts/Ch Memory Option for SDA 8 Zi. Includes an additional 4 GB of RAM (8 GB total)	SDA8Zi-M-64
64 Mpts/Ch Memory Option for DDA 8 Zi. Includes an additional 4 GB of RAM (8 GB total)	DDA8Zi-M-64
128 Mpts/Ch Memory Option for WaveMaster 8 Zi. Includes an additional 4 GB of RAM (8 GB total)	WM8Zi-L-128
128 Mpts/Ch Memory Option for SDA 8 Zi. Includes an additional 4 GB of RAM (8 GB total)	SDA8Zi-L-128
128 Mpts/Ch Memory Option for DDA 8 Zi. Includes an additional 4 GB of RAM (8 GB total)	DDA8Zi-L-128
256 Mpts/Ch Memory Option for WaveMaster 8 Zi. Includes an additional 4 GB of RAM (8 GB total)	WM8Zi-VL-256
256 Mpts/Ch Memory Option for SDA 8 Zi. Includes an additional 4 GB of RAM (8 GB total)	SDA8Zi-VL-256
256 Mpts/Ch Memory Option for DDA 8 Zi. Includes an additional 4 GB of RAM (8 GB total)	DDA8Zi-VL-256

CPU, Computer and Other Hardware Options

Upgrade from 4 GB to 8 GB CPU RAM	WM8Zi-4-UPG-8GBRAM
Upgrade from Standard Size Hard Drive to 200 GB Hard Drive	WM8Zi-200GB-HD
Additional 120 GB Hard Drive. Includes Windows® Vista® OS, LeCroy Oscilloscope Software and Critical Scope Operational File Duplicates	WM8Zi-120GB-RHD-02
Additional 200 GB Hard Drive. Includes Windows Vista OS, LeCroy Oscilloscope Software and Critical Scope Operational File Duplicates	WM8Zi-200GB-RHD-02
GPIB Option for LeCroy Oscilloscope. Half-height Card	GPIB-2

Serial Data Options and Accessories

SDA II Serial Data Analysis Option (Standard on SDA 8 Zi and DDA 8 Zi)	WM8Zi-SDAII
100 Mb/s to 3.125 Gb/s High-speed Serial Pattern Trigger Option for 4–30 GHz Oscilloscopes and Disk Drive Analyzers (Standard on SDA 8 Zi)	WM8Zi-HSPT
Eye Doctor II Advanced Signal Integrity Tools	WM8Zi-EYEDRII
Cable De-embed Option (Standard on SDA 8 Zi and DDA 8 Zi)	WM8Zi-CBL-DE-EMBED
8b/10b Decode Option (Standard on SDA 8 Zi and DDA 8 Zi)	WM8Zi-8B10B D
Ethernet Application Software	QPHY-ENET*
USB Application Software	QPHY-USB†

*TF-ENET-B required. †TF-USB-B required.

ORDERING INFORMATION

Product Description Product Code

Serial Data Options and Accessories (cont'd)

PCIe Gen1 Compliance and Development Software Package	QPHY-PCIe
QualiPHY Enabled SATA Software Option	QPHY-SATA
WiMedia UWB Transmitter Measurement Software Option	QPHY-UWB
QualiPHY Enabled DisplayPort Software Option	QPHY-DisplayPort
QualiPHY Enabled HDMI Software Option	QPHY-HDMI [‡]
I ² C Bus Trigger and Decode Option	WM8Zi-I2Cbus TD
SPI Bus Trigger and Decode Option	WM8Zi-SPIbus TD
LIN Trigger and Decode Option	WM8Zi-LINbus TD
UART and RS-232 Trigger and Decode Option	WM8Zi-UART-RS232bus TD
FlexRay Trigger and Decode Option	WM8Zi-FlexRayBus TD
FlexRay Bus Trigger, Decode, and Physical Layer Test Option	WM8Zi-FlexRayBus TDP
CANbus TDM Trigger, Decode and Measure/Graph Option	WM8Zi-CANbus TDM
CANbus TD Trigger and Decode Option	WM8Zi-CANbus TD

[‡] TF-HDMI-3.3V-QUADPAK required.

High-speed Digitizer Output

High-speed PCIe Gen1 x4 Digitizer Output	LSIB-1
PCI Express X4 Host Interface Board for Desktop PC	LSIB-HOSTBOARD
PCI Express X4 Express Card Host Interface for Laptop Express Card Slot	LSIB-HOSTCARD
PCI Express X4 3-meter Cable with X4 Cable Connectors Included	LSIB-CABLE-3M
PCI Express X4 7-meter Cable with X4 Cable Connectors Included	LSIB-CABLE-7M

Mixed Signal Testing Options

500 MHz, 2 GS/s, 18 Ch, 50 Mpts/Ch Mixed Signal Oscilloscope Option	MS-500
250 MHz, 1 GS/s, 36 Ch, 25 Mpts/Ch (500 MHz, 18 Ch, 2 GS/s, 50 Mpts/Ch Interleaved) Mixed Signal Oscilloscope Option	MS-500-36
250 MHz, 1 GS/s, 18 Ch, 10 Mpts/Ch Mixed Signal Oscilloscope Option	MS-250

General Purpose and Application Specific Software Options

Eye Doctor II Advanced Signal Integrity Tools	WM8Zi-EYEDRII
Advanced Customization Software Package	WM8Zi-XDEV
Spectrum Analyzer and Advanced FFT Option	WM8Zi-SPECTRUM
Digital Filter Software Package	WM8Zi-DFF2
Jitter Timing and Analysis Software Package (Standard on SDA8 Zi and DDA 8 Zi)	WM8Zi-JTA2
Serial Data Mask Software Package (Standard on SDA 8 Zi and DDA 8 Zi)	WM8Zi-SDM
Disk Drive Measurements Software Package (Standard on DDA 8 Zi)	WM8Zi-DDM2
Disk Drive Analyzer Software Package	WM8Zi-DDA
Advanced Optical Recording Measurement Package	WM8Zi-AORM
Electrical Telecom Mask Test Software Package	WM8Zi-ET-PMT
EMC Pulse Parameter Software Package	WM8Zi-EMC
Power Measure Analysis Software Package	WM8Zi-PMA2

Product Description Product Code

General Accessories

Top-mounted, Fully Integrated 15.3" WXGA with Touch Screen Display, Including all Cabling and Software	Zi-EXTDISP-15
Keyboard, USB	KYBD-1
Probe Deskew and Calibration Test Fixture	TF-DSQ
Hard Carrying Case	WM8Zi-HARDCASE
Soft Carrying Case	WM8Zi-SOFTCASE
Rackmount Accessory for Converting a WM8Zi Series Oscilloscope to an 8U Rack-mounted Package	WM8Zi-RACKMOUNT
ProLink to SMA Adapter	LPA-SMA-A
Kit of ProLink to SMA Adapters	LPA-SMA-KIT-A
ProLink to K/2.92 mm Adapter	LPA-K-A
Kit of ProLink to K/2.92 mm Adapters	LPA-K-KIT-A
Oscilloscope Cart with Additional Shelf and Drawer	OC1024
Oscilloscope Cart	OC1021

Probes and Probe Accessories

18 GHz Differential Amplifier	DA18000
13 GHz Differential Probe System	D13000PS
11 GHz Differential Probe System	D11000PS
WaveLink 7.5 GHz, Differential Probe Adjustable Tip Module	D600A-AT*
WaveLink 3.5 GHz, 2.5 V _{p-p} Differential Probe Small Tip Module	D310*
WaveLink 3.5 GHz, 5 V _{p-p} Differential Probe Small Tip Module	D320*
WaveLink 6 GHz, 2.5 V _{p-p} Differential Probe Small Tip Module	D610*
WaveLink 6 GHz, 5 V _{p-p} Differential Probe Small Tip Module	D620*
WaveLink 6 GHz, Differential Positioner Mounted Tip Module	D500PT*
WaveLink ProLink Probe Body	WL-PLink
WaveLink ProBus Probe Body	WL-PBus
2.5 GHz, 0.7 pF Active Probe (±10), Small Form Factor	HFP2500
1.5 GHz, 0.9 pF, 1 MΩ High Impedance Active Probe	ZS1500
Set of 4 ZS1500, 1.5 GHz, 0.9 pF, 1 MΩ High Impedance Active Probe	ZS1500-QUADPAK
7.5 GHz Low Capacitance Passive Probe (±10, 1 kΩ; ±20, 500 Ω)	PP066
1 GHz, Active Differential Probe (±1, ±10, ±20)	AP034
Optical-to-Electrical Converter, 500–870 nm ProLink BMA Connector	OE525
Optical-to-Electrical Converter, 950–1630 nm ProLink BMA Connector	OE555
10/100/1000Base-T Compliance Test Fixture	TF-ENET-B [†]
Telecom Adapter Kit 100 Ω Bal., 120 Ω Bal., 75 Ω Unbal.	TF-ET
SATA Gen1/Gen2 Compliance Test Fixture	TF-SATA
USB 2.0 Testing Compliance Test Fixture	TF-USB-B

* For a complete probe, order a W-PLink or WL-PBus Probe Body with the Probe Tip Module.

[†] Includes ENET-2CAB-SMA018 and ENET-2ADA-BNCSMA.

A variety of other active voltage and current probes are also available. Consult LeCroy for more information.

Customer Service

LeCroy oscilloscopes and probes are designed, built, and tested to ensure high reliability. In the unlikely event you experience difficulties, our digital oscilloscopes are fully warranted for three years and our probes are warranted for one year.

This warranty includes:

- No charge for return shipping • Long-term 7-year support
- Upgrade to latest software at no charge



1-800-5-LeCroy
www.lecroy.com

**Local sales offices are located throughout the world.
Visit our website to find the most convenient location.**

© 2009 by LeCroy Corporation. All rights reserved. Specifications, prices, availability, and delivery subject to change without notice. Product or brand names are trademarks or registered trademarks of their respective holders. PCI Express® is a registered trademark and/or service mark of PCI-SIG.

WM8ZIDS_26Feb09
10K LG